

Planar Simplicity M Series



SLM432	 	SLM432-T
SLM502	 	SLM502-T
SLM552	 	SLM552-T
SLM652	 	SLM652-T
SLM752	 	SLM752-T
SLM862	 	SLM862-T

Copyright © March 2024 by Planar Systems, Inc.
All rights reserved.

This document may not be copied in any form without permission from Planar. Information in this document is subject to change without notice.

Trademark Credits

Windows™ is a trademark of Microsoft Corp.

Planar utilizes HDMI® standards in this product. The terms HDMI, HDMI High-Definition Multimedia Interface, HDMI Trade dress and the HDMI Logos are trademarks or registered trademarks of HDMI Licensing Administrator, Inc.

All other companies are trademarks or registered trademarks of their respective companies.

Disclaimer

The information contained in this document is subject to change without notice. Planar Systems, Inc. makes no warranty of any kind with regard to this material. While every precaution has been taken in the preparation of this manual, the Company shall not be liable for errors or omissions contained herein or for incidental or consequential damages in connection with the furnishing, performance, or use of this material.

Warranty and Service Plans

Planar warranty and service plans will help you maximize your investment by providing great support, display uptime, and performance optimization. From post-sale technical support, to a full suite of depot services, our services are performed by trained employees. When you purchase a Planar product, you get more than a display; you get the service and support you need to maximize your investment. To find the latest warranty and service information regarding your Planar product, please visit <http://www.planar.com/support>

Software Update Support

Software update support for cyber security and other product issues is provided at minimum for the same period of time as the product warranty period. To find the latest warranty and service information regarding your Planar product, please visit <http://www.planar.com/support>

RoHS Compliance Statement

The Planar Simplicity M Series is fully RoHS compliant.

Part Number: 020-1429-00A

Table of Contents

Introduction	6
1. Safety Information.....	7
2. Safety Precautions.....	7
2.1 Important Safety Instructions	8
2.2 Informations sur la sécurité.....	9
2.3 Précautions de sécurité	9
2.4 Consignes de sécurité importantes.....	10
3. Recommended Usage	12
3.1 Burn-In Versus Temporary Image Retention	12
3.2 Warranty Coverage	12
3.3 Important Waste Disposal Information.....	13
3.4 Normal Usage Guidelines.....	13
3.5 ENERGY STAR Certified	14
4. VESA Mounts, General Description.....	15
5. Cleaning the Display.....	16
Package Contents	17
6. Installing the Cable Clips	19
6.1 Planar M Simplicity Series - Standard Inputs.....	20
SLM432 / SLM432-T	20
SLM502 / SLM502-T	21
SLM552 / SLM552-T	22
SLM652 / SLM652-T	23
SLM752 / SLM752-T	24
SLM862 / SLM862-T	25
Installing the Display	26
7. Before You Begin.....	26
7.1 Tools/Equipment List.....	26
7.2 Other Things You May Need	26
7.3 Plan Your Installation.....	26
7.4 Prepare Your Installation Location.....	27
7.5 Cable Length Recommendations.....	27
Operating the Display	28
8. OSD Keypad.....	28

9.	Remote Control Receiver	29
10.	LED Indicators	30
11.	Using the Display in Flat or Tilted Orientation.....	31
12.	IR Command Protocol	32
13.	Pairing the Remote Control to the Display	36
14.	Remote Control Basic Functions	37
14.1	Turning the Display On.....	37
14.2	Turning the Display Off.....	37
14.3	Adjusting the Volume	37
14.4	Selecting the Input Source	37
14.5	Navigating Through the Menus.....	37
14.6	Battery Replacement/Installation	38
15.	OSD Initial Settings Menu.....	40
15.1	Initial Configuration / Importing Settings	40
16.	Input Menu.....	46
16.1	Source Options	46
17.	Using the Touch Screen	47
18.	OSD Main Menu	48
18.1	Picture.....	48
18.2	Screen.....	51
18.3	Audio.....	53
18.4	Configuration 1.....	55
18.5	Configuration 2.....	58
18.6	Advanced Settings	61
19.	OSD Android Settings Menu.....	67
19.1	Android Main Menu	67
19.2	Settings	67
Network & Internet.....		68
Signage Display		70
Apps.....		78
Display		79
Security		80
System		81
19.3	Apps.....	83
19.4	Network.....	83
19.5	Storage	84

20. Creating a Custom Splash Screen Logo.....	85
21. Media Player.....	90
21.1 Supported Media Formats	90
21.2 Main Menu	91
22. Browser Menu.....	96
22.1 Compose.....	96
22.2 Settings	100
22.3 Boot on Source Functionality.....	101
23. Content Management System	102
External Control	103
Signal Compatibility	104
Color Subsampling Support.....	105
Power Consumption	106
Specifications	107
Dimensions	110
SLM432	110
SLM432-T	111
SLM502	112
SLM502-T	113
SLM552	114
SLM552-T	115
SLM652	116
SLM652-T	117
SLM752	118
SLM752-T	119
SLM862	120
SLM862-T	121
Troubleshooting	122
Accessing the Planar Technical Support Website	123

Introduction

The second generation Planar® Simplicity™ M Series is a line of 43", 50", 55", 65", 75", and 86" 4K resolution (3840 x 2160) LCD displays with 500-nit brightness and updated electronics. The displays offer 4K at 60Hz streaming, media playback, a sleek design and commercial functionality in an affordable 4K digital signage solution.

Featuring an elegant design with logo-free narrow bezel and slim profile, the Planar Simplicity M Series is the ideal display solution for digital signage applications in retail stores, restaurants, medical offices, corporate meeting areas and hospitality. Interactive touch models are also available for collaborative meeting spaces.

Designed for commercial installations, Planar Simplicity M Series comes standard with a full array of connectivity, including USB-C, and external control, including support for native 4K resolution at up to 60Hz via HDMI 2.0, enabling smooth motion video and mouse tracking.

Features of the Planar Simplicity M Series displays include:

- 43", 50", 55", 65", 75" and 86" 4K LCD displays
- 500-nit brightness
- Projected Capacitive touch screen models, featuring protective glass, available

Caution: This manual is intended for use by qualified service persons and end users with experience installing LCD displays.

1. Safety Information

Before using the Planar Simplicity M Series, please read this manual thoroughly to help protect against damage to property, and to ensure personnel safety.

- Be sure to observe the following instructions.
- For your safety, be sure to observe ALL the warnings detailed in this manual.
- For installation or adjustment, please follow this manual's instructions, and refer all servicing to qualified service personnel.

2. Safety Precautions

- **If water is spilled or objects are dropped inside the display, remove the power plug from the outlet immediately.** Failure to do so may result in fire or electrical shock. Contact your dealer for inspection.
- **If the display is dropped or the chassis is damaged, remove the power plug from the outlet immediately.** Failure to do so may result in fire or electrical shock. Contact your dealer for inspection.

WARNING! Wall mounts must be secure.

- **If the display is hung on a wall, the wall must be strong enough to hold it.** Simply mounting it to wallboard or wall paneling won't be adequate or safe.

Caution: The screen could be damaged by heavy pressure.

- **Slight pressure on the LCD will cause distortion of the image.** Heavier pressure will cause permanent damage. Displays should be mounted where viewers cannot touch the screen or insert small objects in the openings that will create hazards by contacting bare conductive parts.

Caution: The front polarizer is soft and subject to scratches from sharp objects.

- **The polarizer is a thin sheet of film laminated to the outside layer of glass on the LCD screen.** Take care when handling items near the screen.
- **If the power cord or plug is damaged or becomes hot, turn off the main power switch of the display. Make sure the power plug has cooled down and remove the power plug from the outlet.** If the display is still used in this condition, it may cause a fire or an electrical shock. Contact your dealer for a replacement.

2.1 Important Safety Instructions

1. Read these instructions.
2. Keep these instructions.
3. Heed all warnings.
4. Follow all instructions.
5. Do not use the display near water.
6. Clean the LCD screens with an LCD screen cleaner or LCD wipes.
7. Do not install near any heat sources such as radiators, heat registers, stoves or other apparatus (including amplifiers) that produce heat.
8. Do not defeat the safety purpose of the polarized or grounding type plug. A polarized plug has two blades with one wider than the other. A grounding type plug has two blades and a third grounding prong. The wide blade or the third prong is provided for your safety. When the provided plug does not fit into your outlet, consult an electrician for the replacement of the obsolete outlet.
9. Protect the power cord from being walked on or pinched, particularly at plugs, convenience receptacles and the point where they exit from any Planar large format LCD display.
10. Only use the attachments/accessories specified by the manufacturer.
11. Unplug all displays during lightning storms or when unused for long periods of time.
12. In instances where a power surge has occurred and a display no longer has an image, the display power will need to be reset.
13. You must follow all National Electrical Code regulations. In addition, be aware of local codes and ordinances when installing your system.
14. Refer all servicing to qualified service personnel. Servicing is required when any of the displays have been damaged in any way, such as the AC power cord or plug is damaged, liquid has been spilled or objects have fallen into a product, the products have been exposed to rain or moisture, do not operate normally or have been dropped.
15. Keep the packing material in case the equipment should ever need to be shipped.
16. Wall mounts must be secure. The wall must be strong enough to hold displays brackets, cables and accessories. Seismic engineers should be consulted in areas prone to earthquakes.
17. **Caution:** There is a risk of explosion if the battery is replaced with an incorrect type. Dispose of used batteries in accordance with local regulations.
18. Slight pressure on the LCD will cause distortion of the image. Heavier pressure will cause permanent damage. Displays should be mounted where viewers cannot touch the screen or insert small objects in the openings that will create hazards by contacting bare conductive parts.
19. The front polarizer is soft and subject to scratches from sharp objects. The polarizer is a thin sheet of film laminated to the outside layer of glass on the LCD screen. Take care when handling items near the screen.

20. USB Media play function may need to be restarted after ESD discharge to back of display.

2.2 Informations sur la sécurité

Avant d'utiliser le Série Planar Simplicity M, veuillez lire attentivement ce manuel pour éviter tout dommage matériel et assurer la sécurité du personnel.

- Assurez-vous de respecter les instructions suivantes.
- Pour votre sécurité, veuillez respecter TOUS les avertissements détaillés dans ce manuel.
- Pour l'installation ou le réglage, suivez les instructions de ce manuel et confiez l'entretien à un personnel qualifié.

2.3 Précautions de sécurité

- **Si de l'eau est renversée ou si des objets sont tombés à l'intérieur de l'écran, débranchez immédiatement la fiche d'alimentation de la prise.** Le non-respect de cette consigne peut entraîner un incendie ou une électrocution. Contactez votre revendeur pour qu'il procède à une inspection.
- **Si l'écran est tombé ou si le châssis est endommagé, débranchez immédiatement la fiche d'alimentation de la prise.** Le non-respect de cette consigne peut entraîner un incendie ou une électrocution. Contactez votre revendeur pour qu'il procède à une inspection.

AVERTISSEMENT! Les supports muraux doivent être sécurisés.

- **Si l'écran est accroché à un mur, celui-ci doit être suffisamment solide pour le supporter.** Un simple montage sur une plaque de plâtre ou un panneau mural n'est ni suffisant ni sécuritaire.

Attention : Pour le modèle non tactile :

- Le polariseur avant du modèle SLMxx2 non tactile est souple et peut être rayé par des objets pointus.
- Une légère pression sur l'écran LCD du modèle SLMxx2 non tactile entraînera une distorsion de l'image. Une pression plus forte causera des dommages permanents.

Attention : Pour tous les modèles SLMxx2 :

- Les écrans doivent être montés de manière à ce que les spectateurs ne puissent pas insérer de petits objets dans les ouvertures, ce qui créerait des dangers en touchant des pièces conductrices nues.
- Si le cordon d'alimentation ou la fiche est endommagé(e) ou devient chaud(e), éteignez l'interrupteur principal de l'écran. Assurez-vous que la fiche d'alimentation a refroidi et retirez-la de la prise de courant. Si vous continuez à utiliser l'écran dans cet état, vous risquez de provoquer un incendie ou une électrocution. Contactez votre revendeur pour un remplacement.

2.4 Consignes de sécurité importantes

1. Lisez ces consignes.
2. Conservez ces consignes.
3. Tenez compte de tous les avertissements.
4. Suivez toutes les consignes.
5. N'utilisez pas l'écran près de l'eau.
6. Nettoyez les écrans LCD avec un nettoyeur ou des lingettes prévus pour ce type d'appareil.
7. N'installez pas l'appareil près de sources de chaleur telles que radiateurs, bouches de chaleur, poêles ou autres appareils (y compris les amplificateurs) qui produisent de la chaleur.
8. Ne neutralisez pas le dispositif de sécurité de la fiche polarisée ou de mise à la terre. Une fiche polarisée possède deux lames, l'une plus large que l'autre. Une fiche de mise à la terre a deux lames et une troisième broche de mise à la terre. La lame large ou la troisième broche est prévue pour votre sécurité. Si la fiche fournie ne rentre pas dans votre prise, consultez un électricien pour remplacer la prise obsolète.
9. Protégez le cordon d'alimentation contre les piétinements et les pincements, en particulier au niveau des fiches, des prises de courant et du point de sortie de tout écran LCD grand format de Planar.
10. Utilisez uniquement les accessoires spécifiés par le fabricant.
11. Débranchez tous les écrans pendant les orages ou lorsque vous ne les utilisez pas pendant de longues périodes.
12. Dans les cas où une surtension s'est produite et qu'un écran n'a plus d'image, il faudra réinitialiser l'alimentation de l'écran.
13. Vous devez respecter toutes les règles du Code national de l'électricité. De plus, tenez compte des codes et des règlements locaux lors de l'installation de votre système.
14. Confiez toute réparation à un personnel qualifié. Une réparation est nécessaire lorsque l'un des écrans a été endommagé de quelque manière que ce soit. Par exemple, si le cordon ou la fiche d'alimentation CA est endommagé(e), si du liquide a été renversé ou si des objets sont tombés dans un écran, si les écrans ont été exposés à la pluie ou à l'humidité, s'ils ne fonctionnent pas normalement ou s'ils ont été échappés.
15. Conservez le matériel d'emballage au cas où l'équipement devrait être expédié.
16. Les supports muraux doivent être sécurisés. Le mur doit être suffisamment solide pour supporter les supports, les câbles et les accessoires des écrans. Des ingénieurs sismiques devraient être consultés dans les zones sujettes aux tremblements de terre.

17. **Attention** : Il existe un risque d'explosion si la pile est remplacée par un type incorrect. Éliminez les piles usagées conformément aux règlements locaux.
18. Une légère pression sur l'écran LCD entraînera une distorsion de l'image. Une pression plus forte causera des dommages permanents. Les écrans doivent être montés là où les spectateurs ne peuvent pas toucher l'écran ou insérer de petits objets dans les ouvertures qui créeront des dangers en entrant en contact avec des pièces conductrices nues.
19. Le polariseur avant est souple et sujet aux rayures causées par des objets pointus. Le polariseur est une fine feuille de film laminée sur la couche extérieure de verre de l'écran LCD. Soyez prudent lorsque vous manipulez des objets près de l'écran.
20. Il peut être nécessaire de redémarrer la fonction de lecture multimédia USB après une décharge ESD à l'arrière de l'écran.

3. Recommended Usage

In order to get the most out of your LCD, use the following recommended guidelines to optimize the display.

3.1 Burn-In Versus Temporary Image Retention

Burn-in causes the screen to retain an image essentially forever, with little or no way to correct the problem. Under normal use, an LCD will not experience burn-in, as plasma displays do, nor will it retain images in any way.

Normal use of an LCD is defined as displaying continuously changing video patterns or images. However, LCDs can experience *temporary* image retention when recommended usage guidelines are not followed.

What is Temporary Image Retention?

Temporary image retention (TIR) can occur when a static image is displayed continuously for extended periods of time (12 hours or longer). An electrical charge differential may build up between the electrodes of the liquid crystal, which causes a negative-color video image (color-inverted and brightness-inverted version of the previous image) to be retained when a new image is displayed. This behavior is true for any LCD device from any LCD manufacturer.

TIR is not covered under warranty. See standard warranty terms and conditions for details. Here are some guidelines to help you avoid TIR:

- Use the LCD to show a screen saver, moving images or still pictures that change regularly. When using high-contrast images, reposition the images frequently.
- Turn off the LCD when it is not in use. To use your source computer's Power Options Properties, set up your computer to turn off the display when not in use.

3.2 Warranty Coverage

The following models are warranted for **16 x 7** usage:

- 43": SLM432 | SLM432-T
- 50": SLM502 | SLM502-T
- 55": SLM552 | SLM552-T
- 65": SLM652 | SLM652-T
- 75": SLM752 | SLM752-T
- 86": SLM862 | SLM862-T

Planar recommends turning off the power for **12 hours per day** for optimal performance.

For complete warranty details, please visit www.planar.com/warranty.

3.3 Important Waste Disposal Information

Please recycle or dispose of all electronic waste in accordance with local, state, and federal laws. Additional resources can be found online at <http://www.planar.com/about/green/>.

The crossed-out wheelee bin symbol is to notify consumers in areas subject to Waste Electrical and Electronic Equipment (WEEE) Directive 2012/19/EU that the product was placed on the market after August 13, 2005 and must not be disposed of with other waste. Separate collection and recycling of electronic waste at the time of disposal ensures that it is recycled in a manner that minimizes impacts to human health and the environment. For more information about the proper disposal of electronic waste, please contact your local authority, your household waste disposal service, or the seller from whom you purchased the product.



3.4 Normal Usage Guidelines

Normal use of the LCD is defined as operating in the open air to prevent heat buildup, and without direct or indirect heat sources such as lighting fixtures, heating ducts, or direct sunlight that can cause the modules to experience high operating temperatures. For all modules, do not block fans or ventilation openings. If the LCD module will be installed in a recessed area with an LCD surround or enclosure, ensure adequate openings are applied for proper air flow and ventilation.

At 3000 meters or below, the maximum ambient operating temperature for the LCD module cannot be above 40° C nor below the minimum ambient operating temperature of 0° C. If one of these conditions exists, it is up to the installer to ensure that module placement is changed, thermal shielding is provided and/or additional ventilation is provided to keep the display within its nominal operating parameters.

Cooling Requirements

For optimal performance, active cooling by the installer should be planned for when the ambient temperature at the top of the wall is predicted to be above the specified ambient temperature for the panel. Cooling may be done behind the displays and depending on the wall configuration.

3.5 ENERGY STAR Certified



ENERGY STAR is a program run by the U.S. Environmental Protection Agency (EPA) and U.S. Department of Energy (DOE) that promotes energy efficiency.

The following products qualify for ENERGY STAR in the factory default settings:

- SLM432
- SLM432-T
- SLM502
- SLM502-T
- SLM552
- SLM552-T
- SLM652
- SLM652-T
- SLM752
- SLM752-T
- SLM862
- SLM862-T

The factory default settings are those in which power savings will be achieved. Changing the factory default picture settings or enabling other features will increase power consumption that could exceed the limits necessary to qualify for ENERGY STAR rating.

For more information on the ENERGY STAR program, refer to energystar.gov.

4. VESA Mounts, General Description

VESA mounts are used to secure the Planar Simplicity M Series display. The display can be installed using a variety of VESA mounts available through Planar. If you do not have a VESA mount, and would like to purchase one, contact Planar.

If you purchased a VESA mount, you should have received a separate box with mounting supplies and an installation manual. Follow these instructions carefully.

Caution: Shorter screws will result in insufficient mounting strength and longer screws could puncture parts inside the display. The device may fall, causing serious personal injury or death. To prevent injury, this device must be securely attached to the wall in accordance with the installation instructions supplied with the mount. The mount must be secured to the Planar Simplicity M Series display as noted below:

Applicable Models	Mounting Notes
SLM432 SLM432-T SLM502 SLM502-T SLM552 SLM552-T	Four M6-1.0 VESA mounting locations. 8mm - 10mm thread engagement is required for secure mounting.
SLM652 SLM652-T SLM752 SLM752-T SLM862 SLM862-T	Four M8-1.25 VESA mounting locations. 10mm - 15mm thread engagement is required for secure mounting

Select the correct screw/spacer combination for the mount.

- Prior to installation, make sure you know where all of the mounting points are located.
- Follow all safety precautions outlined in the VESA Installation manual.
- Verify the parts received with the list shown in the VESA Installation manual.

5. Cleaning the Display





If dust collects on the power plug, remove the plug from the outlet and clean off the dust. Dust build-up may cause a fire.

Remove the power plug before cleaning. Failure to do so may result in electrical shock or damage.

Keep the following points in mind when cleaning the surface of the display:

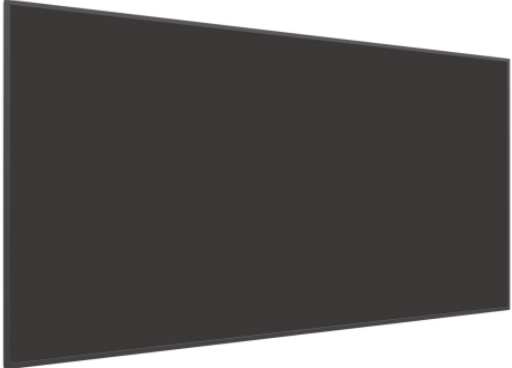
- When the surface of the display becomes dirty, wipe the surface lightly with a soft clean cloth.
- If the surface requires additional cleaning, use LCD screen cleaner or LCD wipes, which are available at most electronics stores.
- Do not let cleaner seep into the display, as it may cause electrical shock or damage.
- Refer to the Planar Display Cleaning Guidelines for more information.

Package Contents

Part	Description	Number	Picture
LCD Display	One per box.	1	
HDMI Cable	HDMI cable.	1	
AC Power Cord (US)	US power cord.	1	
AC Power Cord (EU)	EU power cord.	1	
IR Extender Cable	Receive signals from the remote control.	1	

Part	Description	Number	Picture
USB-C cable	USB-C cable.	1	
Remote Control	Used to control the display (AAA batteries included)	1	
Cable Clips	Used to clamp and organize the cables.	2	
2.5mm to DB9 Adapter	2.5mm (TRRS, male) to DB-9 (female) adaptor.	1	
Quick Start Guide	Quick start guide.	1	
USB A-to-B Cable	Connects to a PC for touch functionality (touch models only)	1	
Passive Stylus	Touch models only.	1	

6. Installing the Cable Clips

Use the cable clips included in the Accessory Kit to assist with cable management. These clips adhere into place using adhesive backing.

Attach clips near HDMI and AC power cables to assist with cable routing and to release cable strain.

6.1 Planar M Simplicity Series - Standard Inputs

SLM432 / SLM432-T

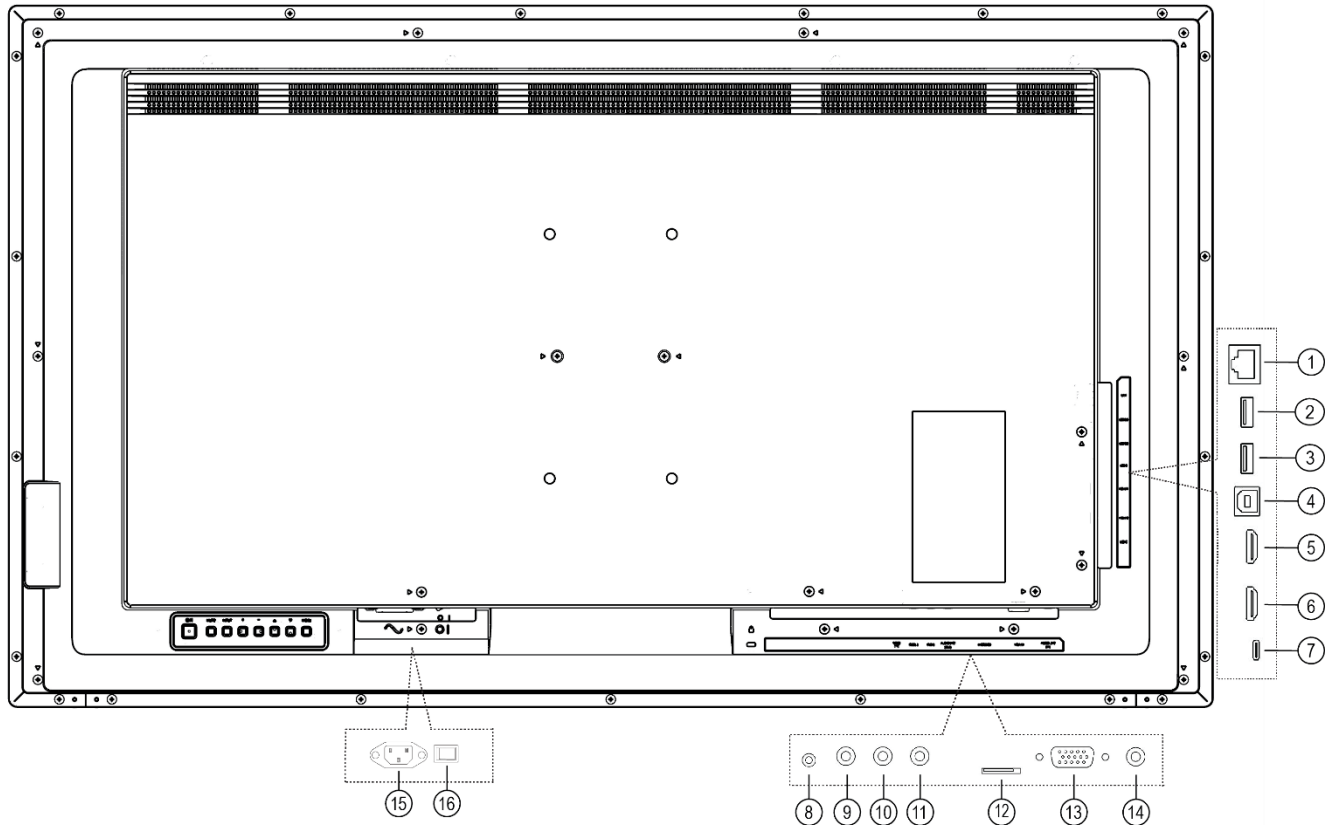

Item	Description
1	LAN: RJ45
2	USB-A 3.0 (female) USB Peripherals
3	USB-A 2.0 (female) USB Peripherals
4	USB-B: Touch (Touch model only)
5	HDMI 1: HDMI, 4K/60Hz, HDCP 2.2
6	HDMI 2: HDMI, 4K/60Hz, HDCP 2.2
7	USB-C: 4K/60Hz, HDCP 2.2, Touch, Power Delivery (65W)
8	RS232(IN): 2.5mm TRRS (female)
9	IR (OUT): 3.5mm TRS (female)
10	IR (IN): 3.5mm TRS (female)
11	AUDIO LINE (OUT): 3.5mm TRS (female)
12	Micro SD
13	VGA IN: DE-15 (female)
14	AUDIO LINE (IN): 3.5mm TRS (female)
15	AC IN: IEC C14
16	AC ON/OFF

SLM502 / SLM502-T

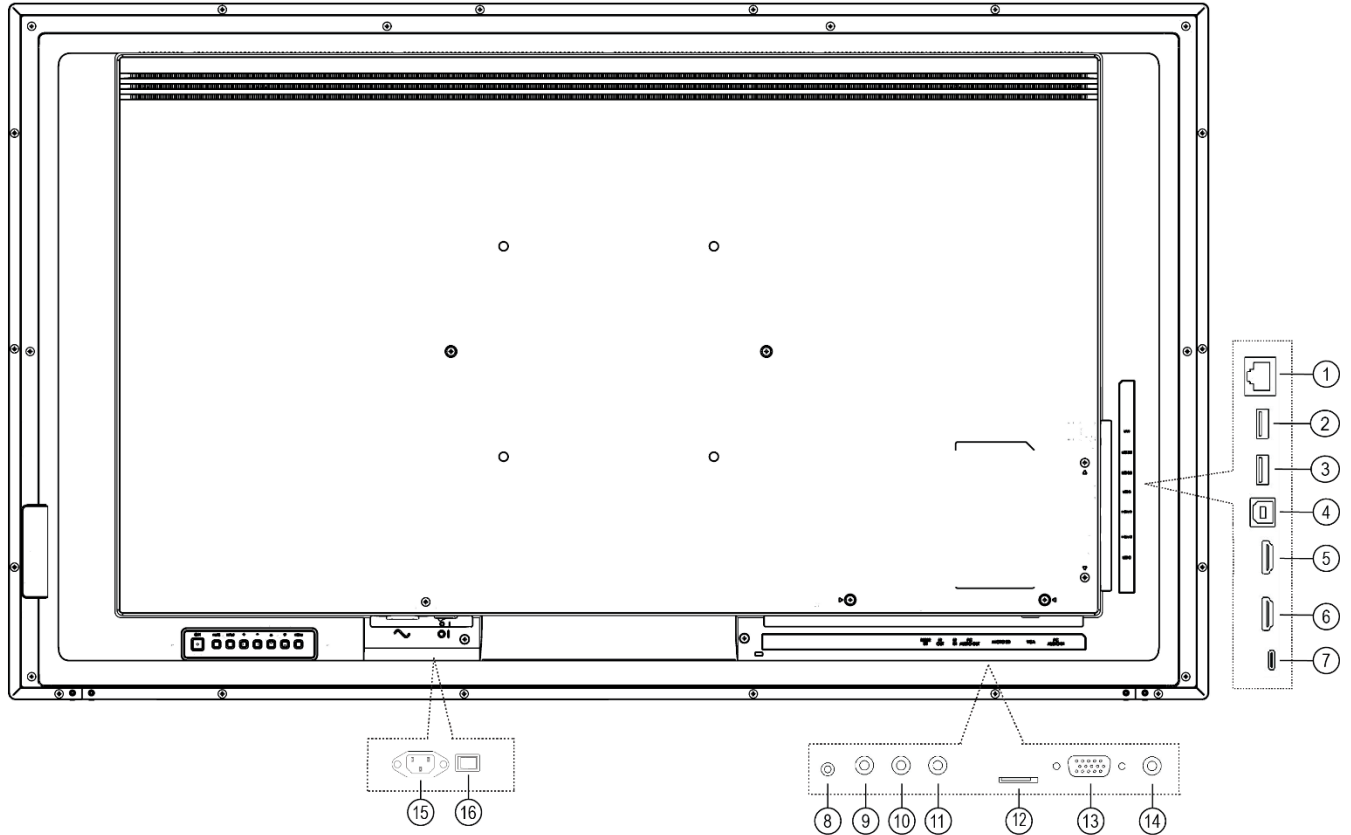

Item	Description
1	LAN: RJ45
2	USB-A 3.0 (female) USB Peripherals
3	USB-A 2.0 (female) USB Peripherals
4	USB-B: Touch (Touch model only)
5	HDMI 1: HDMI, 4K/60Hz, HDCP 2.2
6	HDMI 2: HDMI, 4K/60Hz, HDCP 2.2
7	USB-C: 4K/60Hz, HDCP 2.2, Touch, Power Delivery (65W)
8	RS232(IN): 2.5mm TRRS (female)
9	IR (OUT): 3.5mm TRS (female)
10	IR (IN): 3.5mm TRS (female)
11	AUDIO LINE (OUT): 3.5mm TRS (female)
12	Micro SD
13	VGA IN: DE-15 (female)
14	AUDIO LINE (IN): 3.5mm TRS (female)
15	AC IN: IEC C14
16	AC ON/OFF

SLM552 / SLM552-T

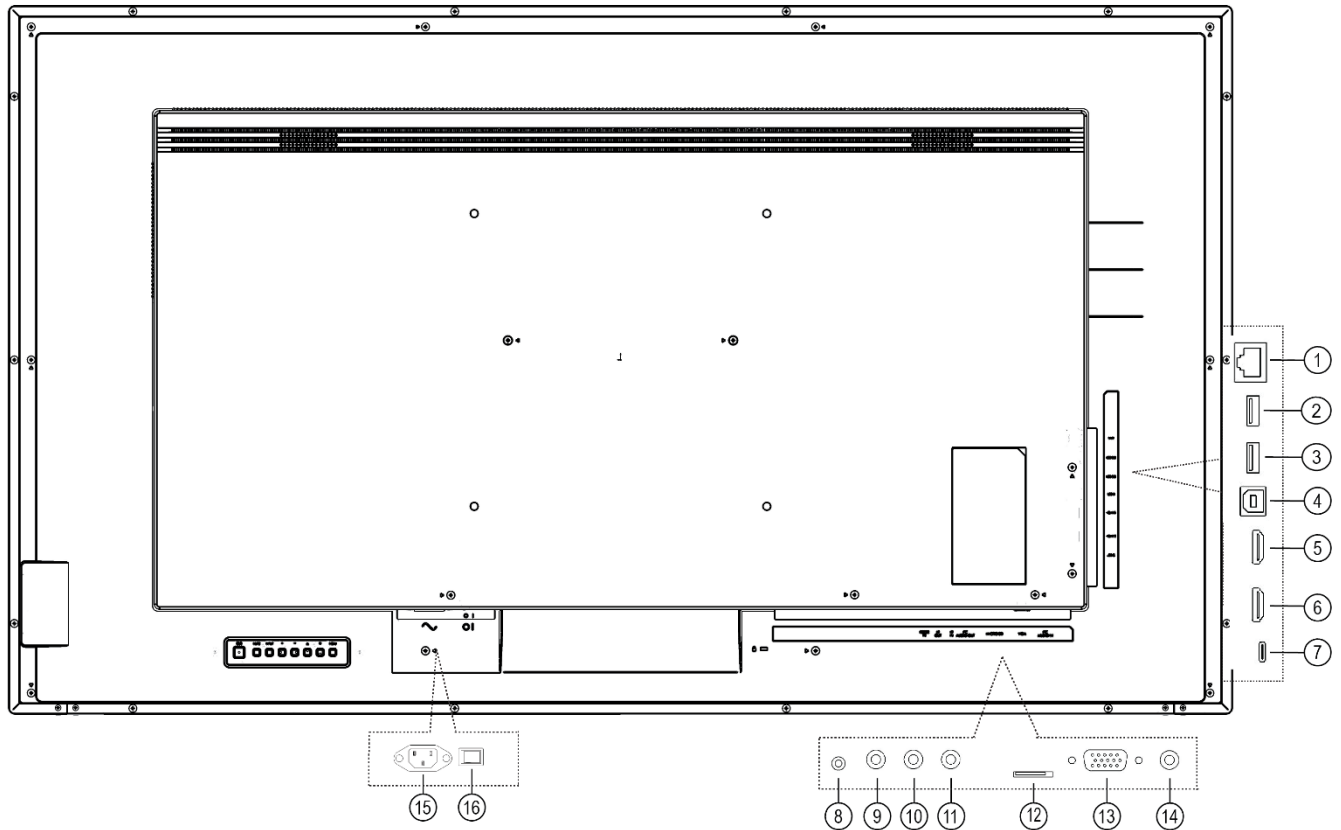

Item	Description
1	LAN: RJ45
2	USB-A 3.0 (female) USB Peripherals
3	USB-A 2.0 (female) USB Peripherals
4	USB-B: Touch (Touch model only)
5	HDMI 1: HDMI, 4K/60Hz, HDCP 2.2
6	HDMI 2: HDMI, 4K/60Hz, HDCP 2.2
7	USB-C: 4K/60Hz, HDCP 2.2, Touch, Power Delivery (65W)
8	RS232(IN): 2.5mm TRRS (female)
9	IR (OUT): 3.5mm TRS (female)
10	IR (IN): 3.5mm TRS (female)
11	AUDIO LINE (OUT): 3.5mm TRS (female)
12	Micro SD
13	VGA IN: DE-15 (female)
14	AUDIO LINE (IN): 3.5mm TRS (female)
15	AC IN: IEC C14
16	AC ON/OFF

SLM652 / SLM652-T

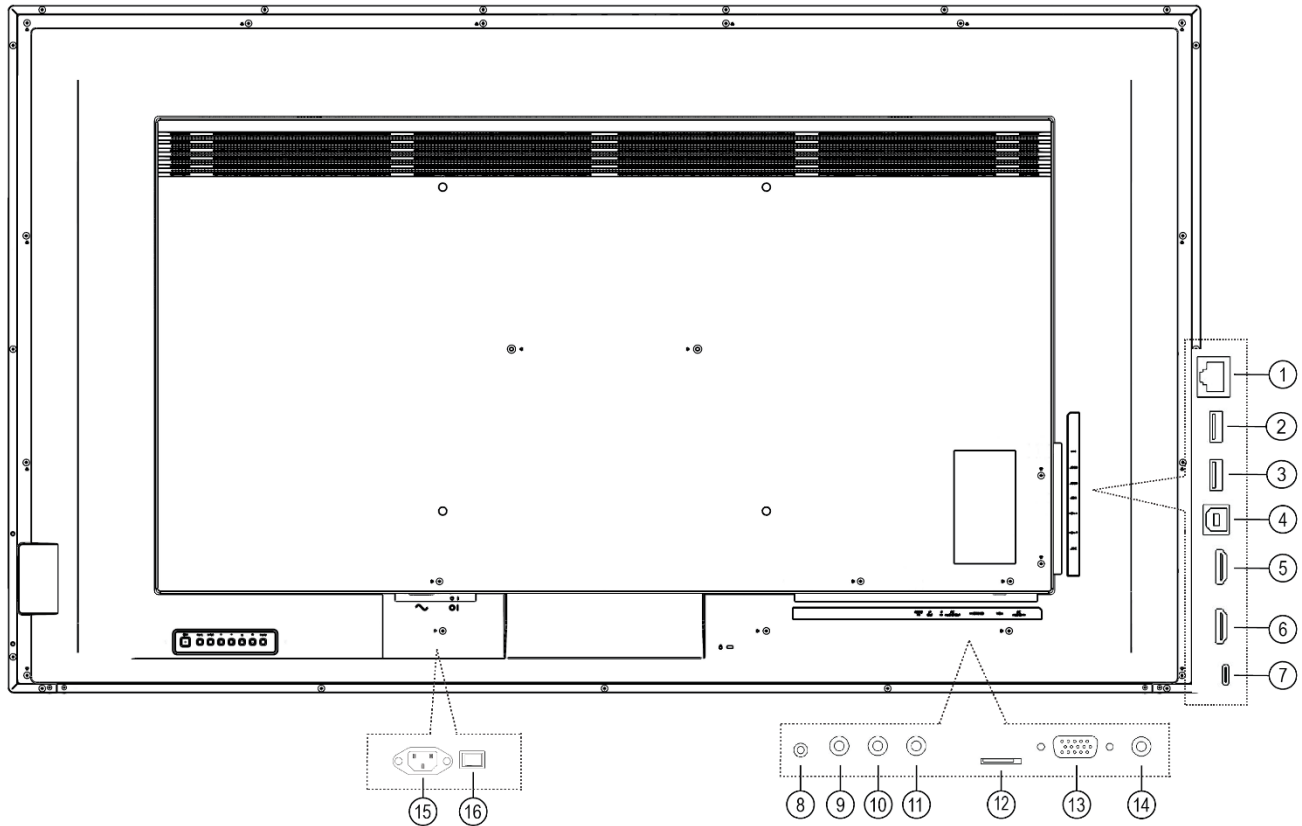

Item	Description
1	LAN: RJ45
2	USB-A 3.0 (female) USB Peripherals
3	USB-A 2.0 (female) USB Peripherals
4	USB-B: Touch (Touch model only)
5	HDMI 1: HDMI, 4K/60Hz, HDCP 2.2
6	HDMI 2: HDMI, 4K/60Hz, HDCP 2.2
7	USB-C: 4K/60Hz, HDCP 2.2, Touch, Power Delivery (65W)
8	RS232(IN): 2.5mm TRRS (female)
9	IR (OUT): 3.5mm TRS (female)
10	IR (IN): 3.5mm TRS (female)
11	AUDIO LINE (OUT): 3.5mm TRS (female)
12	Micro SD
13	VGA IN: DE-15 (female)
14	AUDIO LINE (IN): 3.5mm TRS (female)
15	AC IN: IEC C14
16	AC ON/OFF

SLM752 / SLM752-T

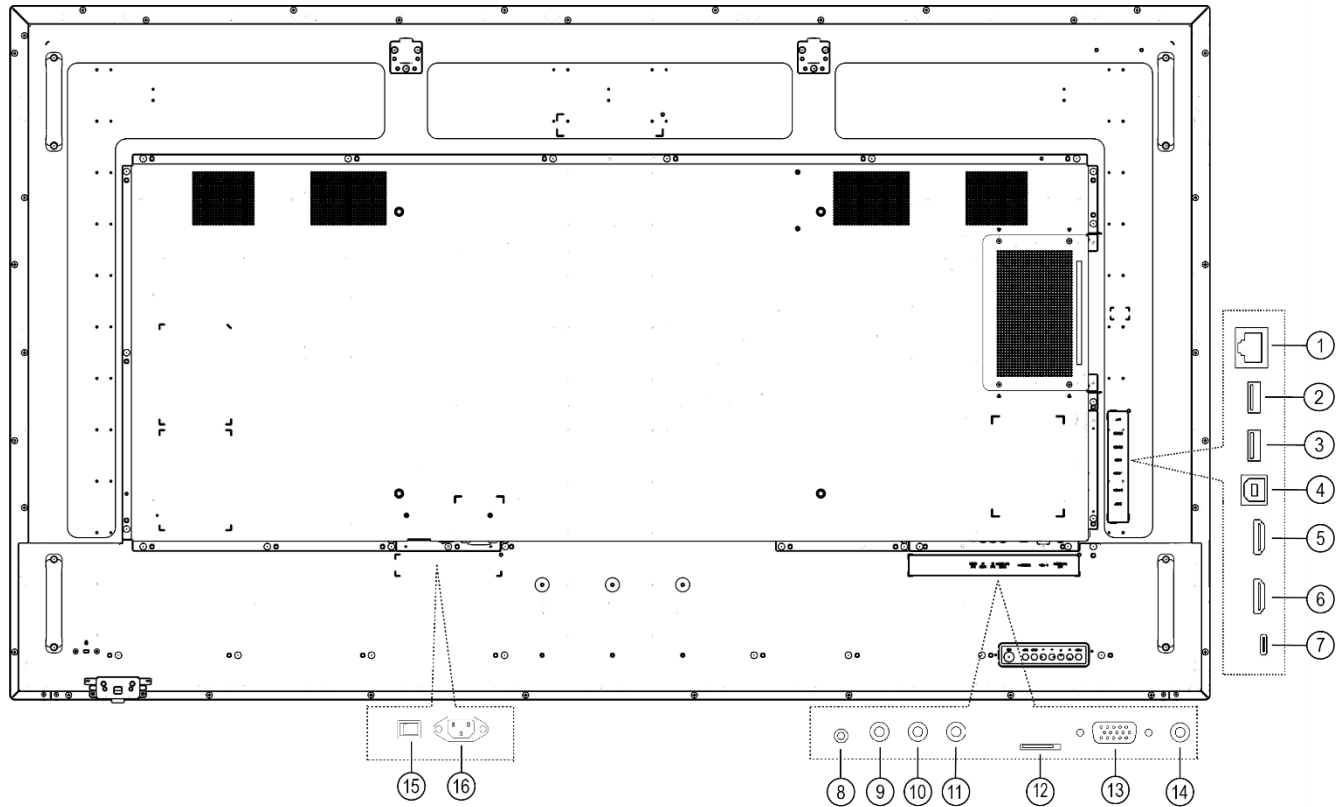

Item	Description
1	LAN: RJ45
2	USB-A 3.0 (female) USB Peripherals
3	USB-A 2.0 (female) USB Peripherals
4	USB-B: Touch (Touch model only)
5	HDMI 1: HDMI, 4K/60Hz, HDCP 2.2
6	HDMI 2: HDMI, 4K/60Hz, HDCP 2.2
7	USB-C: 4K/60Hz, HDCP 2.2, Touch, Power Delivery (65W)
8	RS232(IN): 2.5mm TRRS (female)
9	IR (OUT): 3.5mm TRS (female)
10	IR (IN): 3.5mm TRS (female)
11	AUDIO LINE (OUT): 3.5mm TRS (female)
12	Micro SD
13	VGA IN: DE-15 (female)
14	AUDIO LINE (IN): 3.5mm TRS (female)
15	AC ON/OFF
16	AC IN: IEC C14

SLM862 / SLM862-T

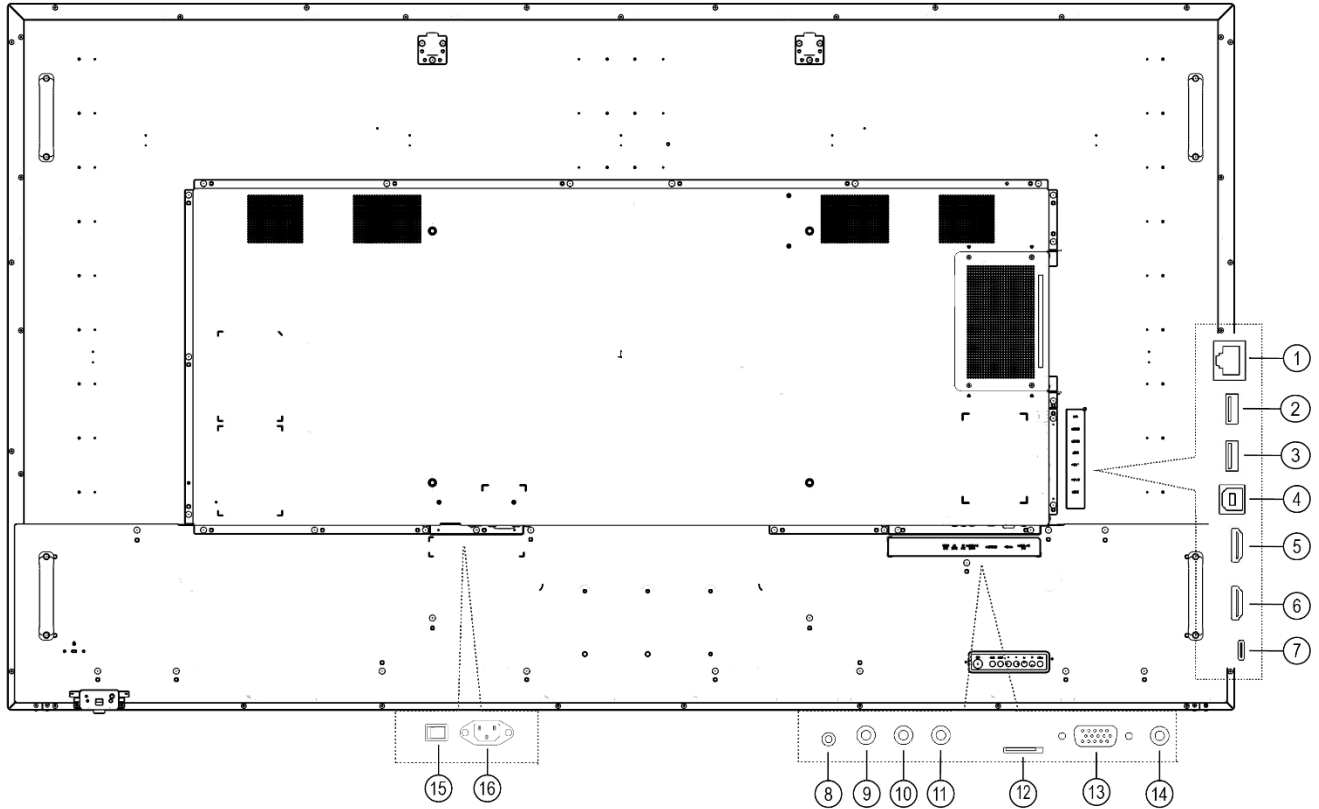

Item	Description
1	LAN: RJ45
2	USB-A 3.0 (female) USB Peripherals
3	USB-A 2.0 (female) USB Peripherals
4	USB-B: Touch (Touch model only)
5	HDMI 1: HDMI, 4K/60Hz, HDCP 2.2
6	HDMI 2: HDMI, 4K/60Hz, HDCP 2.2
7	USB-C: 4K/60Hz, HDCP 2.2, Touch, Power Delivery (65W)
8	RS232(IN): 2.5mm TRRS (female)
9	IR (OUT): 3.5mm TRS (female)
10	IR (IN): 3.5mm TRS (female)
11	AUDIO LINE (OUT): 3.5mm TRS (female)
12	Micro SD
13	VGA IN: DE-15 (female)
14	AUDIO LINE (IN): 3.5mm TRS (female)
15	AC ON/OFF
16	AC IN: IEC C14

Installing the Display

This section explains how to install your display. We suggest that you read the entire section before you attempt to install the unit.

7. Before You Begin

Make sure you have all the items in these lists before you begin unpacking and installing your display(s).

7.1 Tools/Equipment List

Depending on your installation, you may need one or more of the following items:

- String/string level
- Digital/laser level
- Ladders/lift
- Back brace
- Stud finder (if hanging display on a wall)

7.2 Other Things You May Need

- LCD screen cleaner or LCD wipes - available at most electronics stores
- At least two very strong people to help lift unit into place

7.3 Plan Your Installation

You should have a detailed plan of how the units are to be configured. The plan should include calculations for the following:

- Power maximums reference below by display size:
 - SLM432: 13 units max per 20A circuit for 115V operation
 - SLM502: 11 units max per 20A circuit for 115V operation
 - SLM552: 11 units max per 20A circuit for 115V operation
 - SLM652: 7 units max per 20A circuit for 115V operation
 - SLM752: 7 units max per 20A circuit for 115V operation
 - SLM862: 4 units max per 20A circuit for 115V operation
- Cable runs
- Ventilation and cooling requirements
- If hanging display on a wall, location of studs in the wall

7.4 Prepare Your Installation Location

Prepare the area where you will install the unit. If custom enclosures are part of the installation, they must be fully designed to accommodate the installation of the displays, the installed units, and ventilation and cooling requirements.

If your installation includes a lot of construction or dust, it is **highly recommended** that you clean all of the screens after the wall installation and configuration are complete.

7.5 Cable Length Recommendations

Cable length performance may vary between different cables and sources. The recommended maximum cable lengths are as follows:

HDMI

- 4K @ 50/60Hz: 5m (15 ft) maximum
- 4K @ 24/25/30Hz: 15m (50 ft) maximum
- 1080p @ 60Hz and lower resolutions: 20m (65 ft) maximum

USB-C

- 2m maximum

Operating the Display

8. OSD Keypad

The OSD keypad is located on the rear of the display.

SLM432 / SLM502 / SLM552

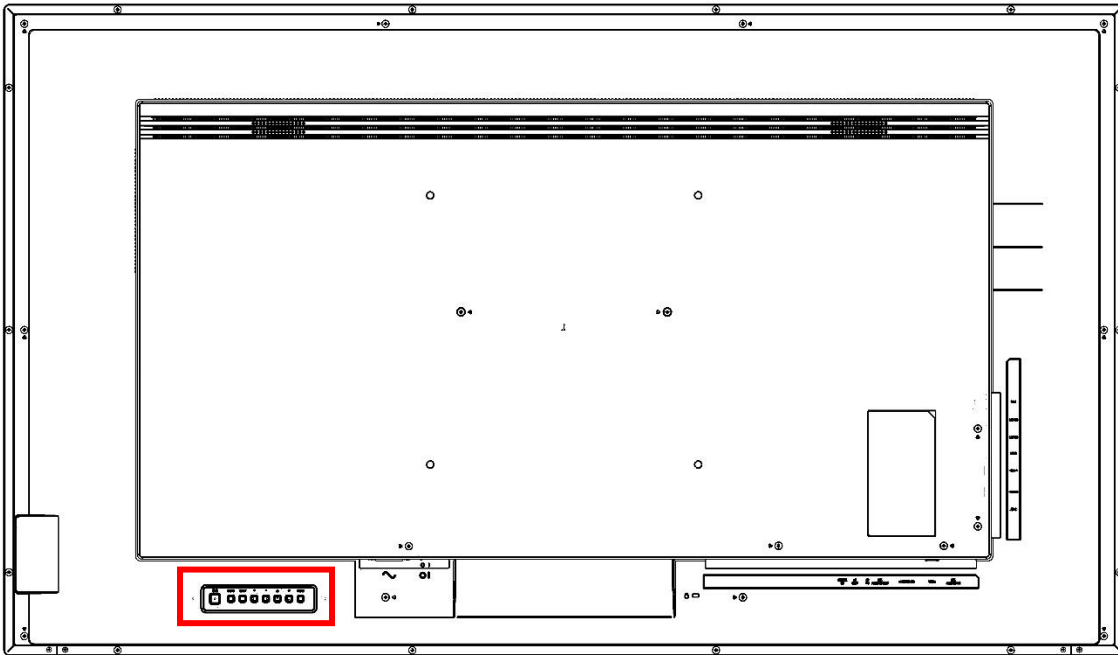

SLM652 / SLM752 / SLM862



OSD Keypad Buttons

Key	Descriptions
Power	Power on / Power off
Mute	Audio Mute
Input	Source Selection
+	Menu Right / Increase value / Volume +
-	Menu Left / Decrease value / Volume -
▲	Menu Up
▼	Menu Down
Menu	Menu open / close

9. Remote Control Receiver

The remote control receiver is located on the front of the display near the bottom right corner. The IR extender cable can be used if remote control reception is needed in a different location.



10. LED Indicators

The LED indicator light is located on the front of the display near the bottom-right corner.

LED On

Power Status	Condition
Green	Power on
Red	Standby Power save mode
Red / Green Blinking	IR codes received
Off	AC off

11. Using the Display in Flat or Tilted Orientation

The display is not recommended for use in flat orientation for tabletop, floor, or ceiling installations. LCD panels of this size are at risk of panel deflection, which can cause cosmetic sagging, brightness uniformity issues, and a shortened life span. Installations where the display is tilted downward or upward at an angle may also be prone to these issues and are not recommended.

Note: Failure to follow these instructions will void the warranty.

12. IR Command Protocol

The Planar Simplicity M Series displays accept commands in the form of IR signals that conform to the NEC protocol. Each Planar Simplicity M Series remote control has an NEC control code associated with it. You can use these codes to program a third-party “universal” remote control to work with the Planar Simplicity M Series displays. These third-party products usually come with a computer software application for this purpose. For more information, consult the documentation provided with the remote control.

Note: In addition to supporting the NEC protocol, Planar Simplicity M Series displays are also compatible with the IR protocol for the predecessor Planar Simplicity 4K displays. Refer to the manual for Planar Simplicity 4K displays, or contact Planar Support for more information.

The IR control codes have the following characteristics:

- Each code consists of the following:
 - A leader pulse (a modulated pulse of 9 ms followed by a non-modulated pulse of 4.5 ms)
 - 16 address bits. The default address is 1785 (0x06F9, binary 00000110 11111001)
 - 16 data bits: eight (8) bits for the command followed by the logical inverse of the command
 - An end pulse (a modulated pulse of 0.56 ms, similar to the modulated pulse in the ‘0’ and ‘1’ bits). The end of the modulated pulse constitutes the end of the data transmission.
 - The carrier frequency is 38 kHz, with the modulated pulses having a 33% duty cycle.
 - Commands are sent at a maximum rate of 9 Hz.

For example, below is the NEC control code for the ON button of the Planar Simplicity M Series remote control (assuming the default address is used).

Hex	06	F9	01	FE
Binary	00000110	11111001	00000001	11111110
Function	Address Byte 1	Address Byte 2	Command	Command (Logical Inverse)
	1	2		

The following example shows the pulse train for this command.



Remote Control Button Name	Address	Data	NEC Data From Remote (Hex Code)	Description
Power	0x42BD	0x0C	0x42BD0CF3	Power toggle
Normal	N/A	N/A	N/A	Sends commands to any displays
ID	N/A	N/A	N/A	Sends commands to only one display (see section 15)
⏮	0x42BD	0x2B	0x42BD2BD4	Rewind
▶	0x42BD	0x2C	0x42BD2CD3	Play
⏭	0x42BD	0x28	0x42BD28D7	Fast forward
■	0x42BD	0x31	0x42BD31CE	Stop
⏸	0x42BD	0x30	0x42BD30CF	Pause
Source	0x42BD	0x38	0x42BD38C7	Opens the source menu
Home	0x42BD	0x54	0x42BD54AB	Opens the menu
Format	0x42BD	0xF5	0x42BDF50A	Selects the aspect ratio
Back (Short Press <1.6s)	0x42BD	0x0A	0x42BD0AF5	Navigate back (one level)
Back (Long Press >1.6s)	0x42BD	0x9F	0x42BD9F60	Navigate back (all levels)
List	0x42BD	0xCC	0x42BDCC33	N/A
Info	0x42BD	0x0F	0x42BD0FF0	Show current input and Signal Information if available
Up	0x42BD	0x58	0x42BD58A7	Navigate up
Down	0x42BD	0x59	0x42BD59A6	Navigate down
Left	0x42BD	0x5A	0x42BD5AA5	Navigate left
Right	0x42BD	0x5B	0x42BD5BA4	Navigate right
OK	0x42BD	0x5C	0x42BD5CA3	Selects the current menu item
Adjust	0x42BD	0x90	0x42BD906F	N/A
Options	0x42BD	0x40	0x42BD40BF	Open Media Player's Toolbar
Light +	0x42BD	0x12	0x42BD12ED	Backlight increase
Light -	0x42BD	0x13	0x42BD13EC	Backlight decrease
Vol +	0x42BD	0x10	0x42BD10EF	Volume increase
Vol -	0x42BD	0x11	0x42BD11EE	Volume decrease
Mute	0x42BD	0x0D	0x42BD0DF2	Audio mute
[Red]	0x42BD	0x6D	0x42BD6D92	Red button
[Green]	0x42BD	0x6E	0x42BD6E91	Green button
[Yellow]	0x42BD	0x6F	0x42BD6F90	Yellow button
[Blue]	0x42BD	0x70	0x42BD708F	Blue button
1	0x42BD	0x01	0x42BD01FE	'1' numeric entry
2	0x42BD	0x02	0x42BD02FD	'2' numeric entry

Remote Control Button Name	Address	Data	NEC Data From Remote (Hex Code)	Description
3	0x42BD	0x03	0x42BD03FC	'3' numeric entry
4	0x42BD	0x04	0x42BD04FB	'4' numeric entry
5	0x42BD	0x05	0x42BD05FA	'5' numeric entry
6	0x42BD	0x06	0x42BD06F9	'6' numeric entry
7	0x42BD	0x07	0x42BD07F8	'7' numeric entry
8	0x42BD	0x08	0x42BD08F7	'8' numeric entry
9	0x42BD	0x09	0x42BD09F6	'9' numeric entry
0	0x42BD	0x00	0x42BD00FF	'0' numeric entry
ID Set	N/A	N/A	N/A	ID set for ID mode (see section 13)
Enter	N/A	N/A	N/A	ID enter for ID mode (see section 13)
On	0x06F9	0x01	0x06F901FE	Power On
Off	0x06F9	0x09	0x06F909F6	Power Off
HDMI 1	0x06F9	0x29	0x06F929D6	Selects the HDMI 1 input
HDMI 2	0x06F9	0x2A	0x06F92AD5	Selects the HDMI 2 input
DVI	0x06F9	0x2E	0x06F92ED1	Selects the USB-C input
VGA	0x06F9	0x2F	0x06F92FD0	Selects the VGA input

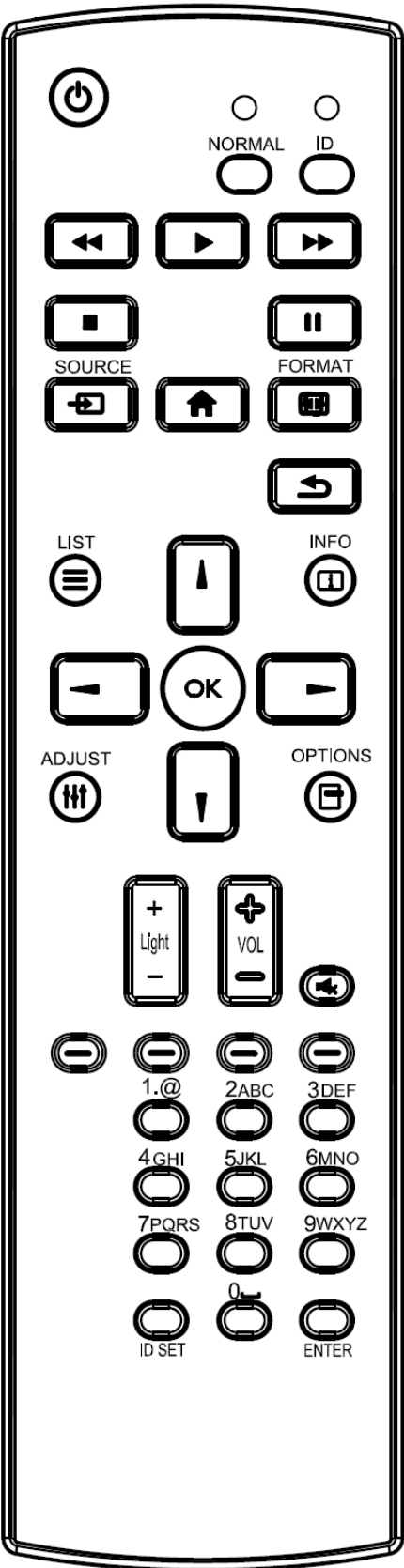

13. Pairing the Remote Control to the Display

The remote control can send commands to any display or to one specific display.

To send commands to all displays: Hold down the NORMAL button on the remote control until the green LED lights. When NORMAL mode is active, the green LED above the NORMAL button will blink when any key on the remote control is pressed.

To send commands to only one display: Hold down the ID button on the remote control until the red LED lights. When the ID mode is active, the red LED above the ID button will blink when any key on the remote control is pressed.

For initial setup of ID mode, perform the following steps:

1. In the OSD, change the Monitor ID setting to a unique value (see page 59).
2. On the remote control, hold down the ID SET button until the red LED above the ID button turns on.
3. Use the 0-9 keys to enter the same value selected for the Monitor ID setting. Press the ENTER key. The red LED will blink twice to confirm the ID code was successfully accepted. The remote control will automatically change to ID mode.
4. Test that the pairing is successful by pressing a remote control key, such as the HOME key. If the key is not accepted by the display, check the Monitor ID setting in the OSD matches the ID code selected on the remote control.

14. Remote Control Basic Functions

14.1 Turning the Display On

1. Insert the power cord into the display and into the power outlet.
2. Ensure the AC switch is set to “—”.
3. Press the power button on the remote or keypad.

14.2 Turning the Display Off

With the power on, press the power button on the remote or keypad to put the LCD panel in a standby mode. To turn off power completely, turn the AC switch to “O” or disconnect the AC power cord from the power outlet.

Note: If there is no signal for a certain period of time, the LCD panel will automatically go into standby mode.

14.3 Adjusting the Volume

1. Using the remote, press the VOL- or VOL+ to increase or decrease the volume.
2. Pressing the MUTE button temporarily turns off all sound. To restore the sound, press the MUTE button again.

Note: The analog audio out is variable. S/PDIF is fixed.

14.4 Selecting the Input Source

Press the SOURCE button on the remote or press the INPUT button on the keypad. Use the arrow buttons to select one of the following input sources and press OK: “HDMI 1, HDMI 2, DVI-D, VGA, Media Player, Browser, CMS, Android, Android App”.

Note: When the display cannot find a source, a “No signal” message will appear.

Note: The app associated with the Android App source can be configured in the Android menu under Settings -> Signage Display -> Source Settings. See page 74 for more information.

14.5 Navigating Through the Menus

1. With the power on, press MENU. The main menu appears.
2. Within the menu, use ▲, ▼, ◀, ▶, and OK to navigate through the menus and adjust options.
3. Press BACK to return to the previous menu. To exit the menu system, press HOME.

14.6 Battery Replacement/Installation

1. Remove the battery cover.

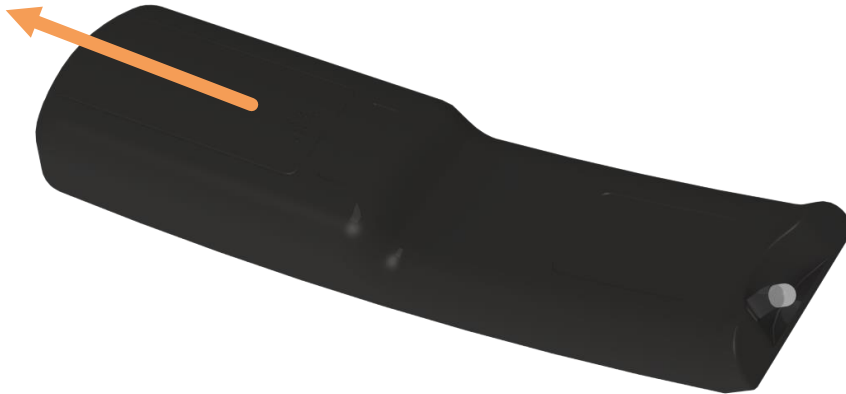

2. Remove the batteries.

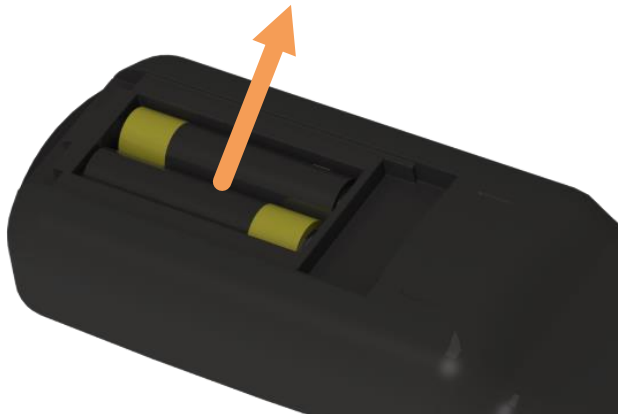

3. Verify the orientation of the replacement battery for each compartment.



4. Install the batteries.

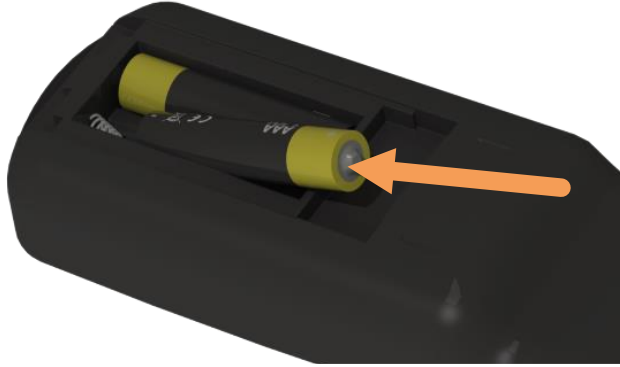

5. Replace the battery cover.



15. OSD Initial Settings Menu

Use this menu to make initial setup adjustments to the OSD (On-Screen Display) menu and other on-screen messages.

When this display is turned on for the first time, initial set-up is required. This process is outlined in the following Initial Configuration section.

Note: The Planar Simplicity M Series models run on a proprietary embedded Android 10 operating system. The pre-installed apps may be updated by their respective developers without prior notice. APKs installed by the user are not guaranteed to operate by Planar. Google Play is not supported. For questions or support regarding third-party apps, please contact the app vendor.

15.1 Initial Configuration / Importing Settings

Welcome Page

1. Select a language and press start.

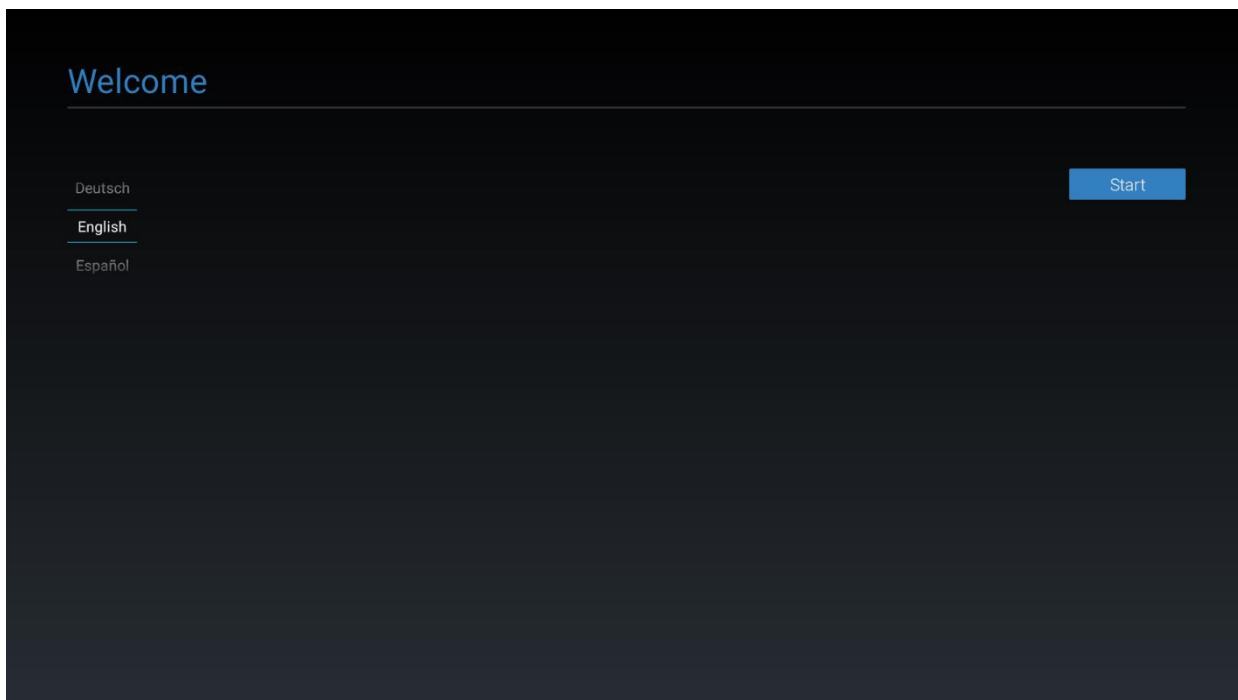

Signage Display Settings

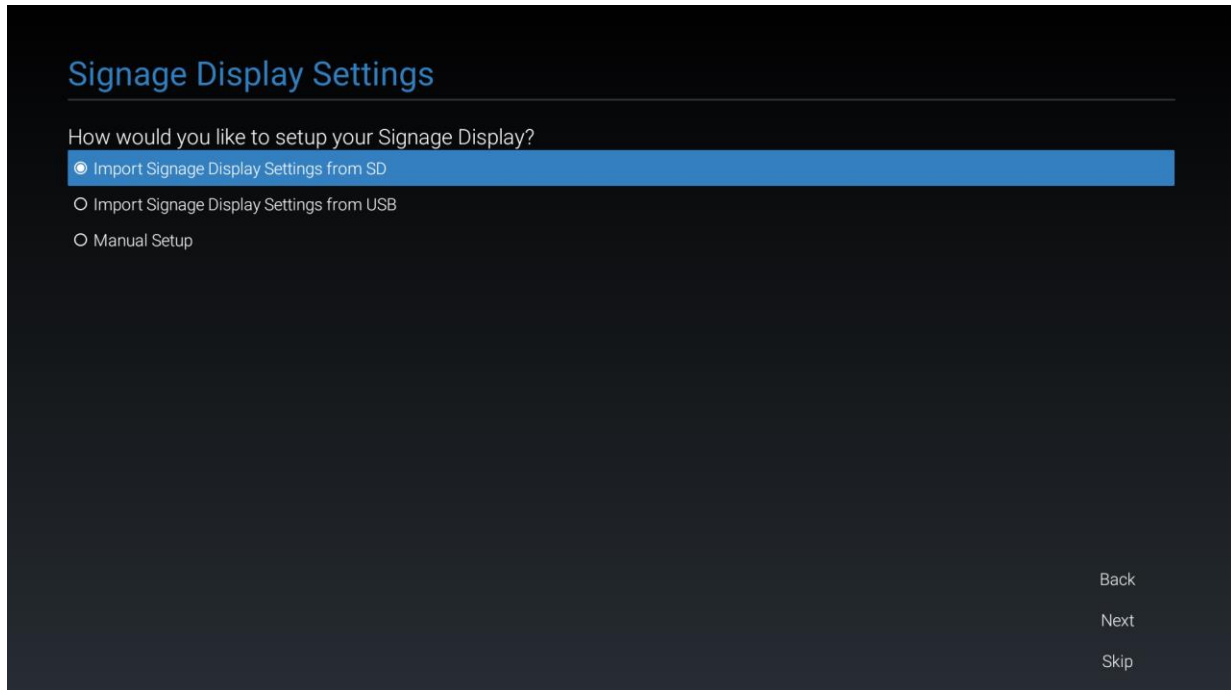

2. Use one of the following setup options:
 - a. Import Signage Display Settings from SD.
 - i. Use settings previously saved to an SD card using the Export Signage Display Settings in the Android OSD (see page 76). This will import all settings except for the Signage Display Name field.
 - b. Import Signage Display Settings from USB
 - i. Use settings previously saved to a USB storage device using the Export Signage Display Settings in the Android OSD (see page 76). This will import all settings except for the Signage Display Name field.
 - c. Manual Setup
 - i. Signage Display Name
 1. Assign a name to the display. By default, this is “PD_” plus the MAC address of the display.

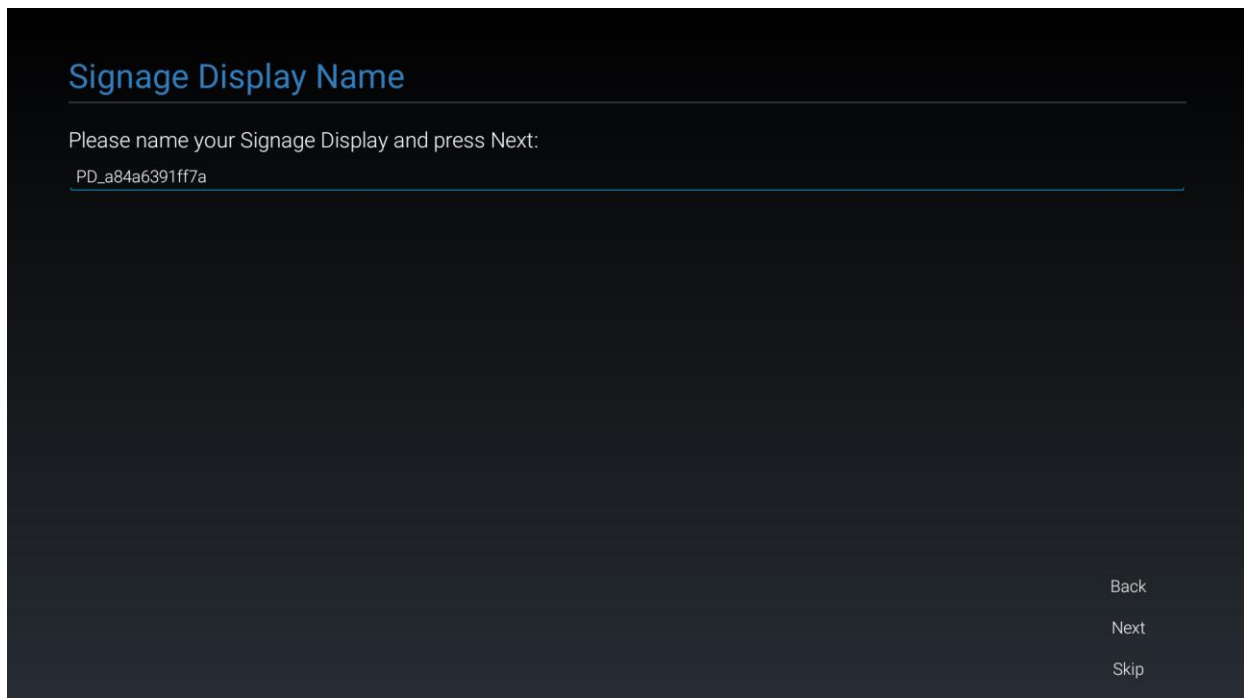

- ii. Security Setup
 - 1. Enable RS232 Network port or allow installation of Unknown Sources.

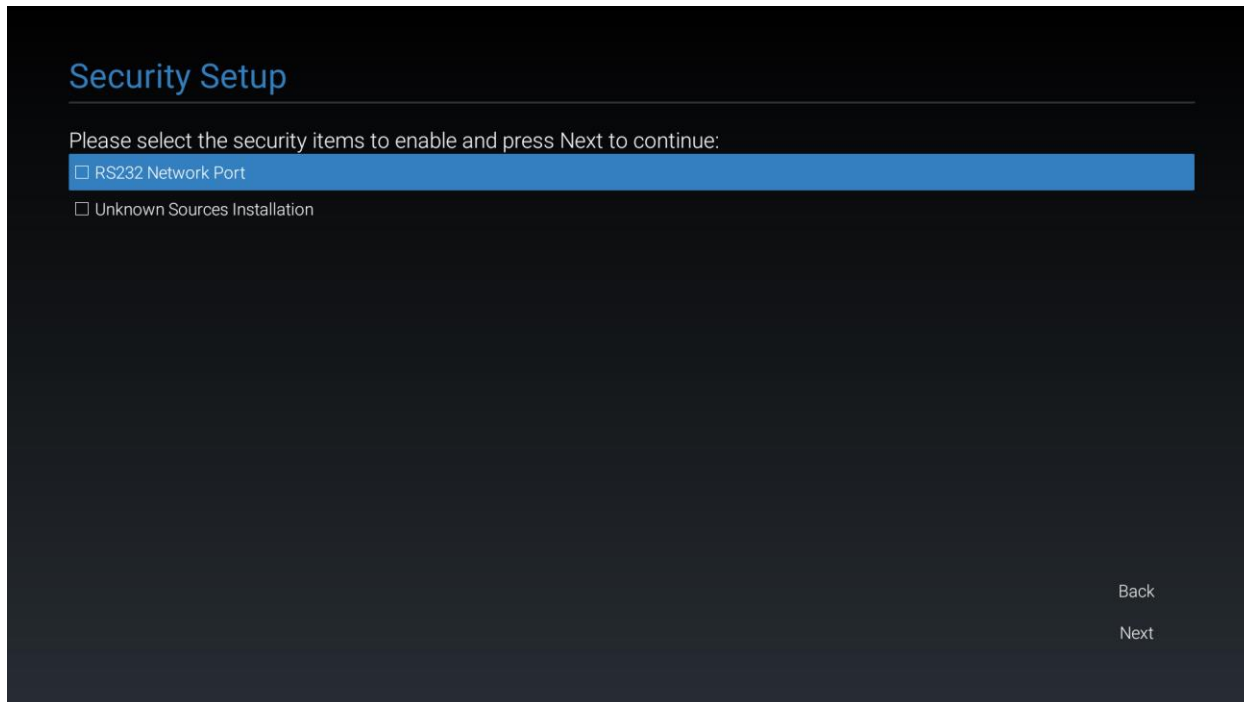

iii. SSH

1. Enable SSH to be able to send RS232 commands over an encrypted connection.

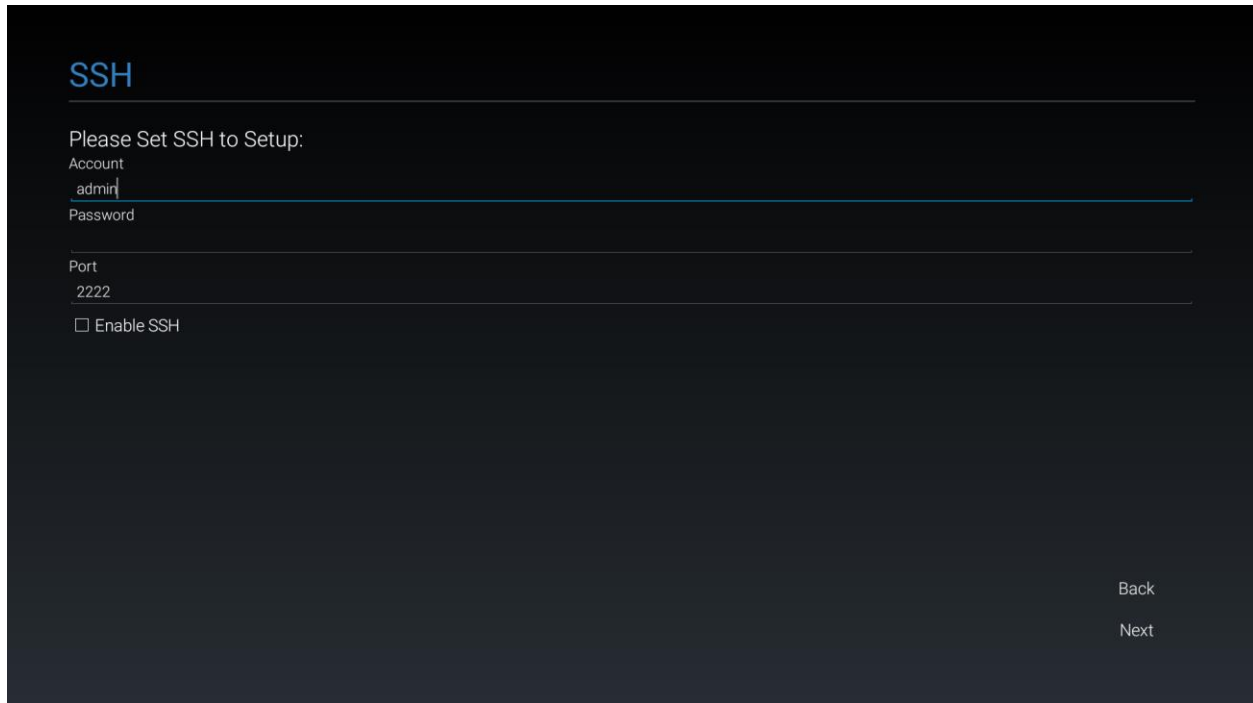

SSH

Please Set SSH to Setup:

Account
admin

Password

Port
2222

Enable SSH

Back

Next

Network Setup

3. If using the network connection, press Next to set up.

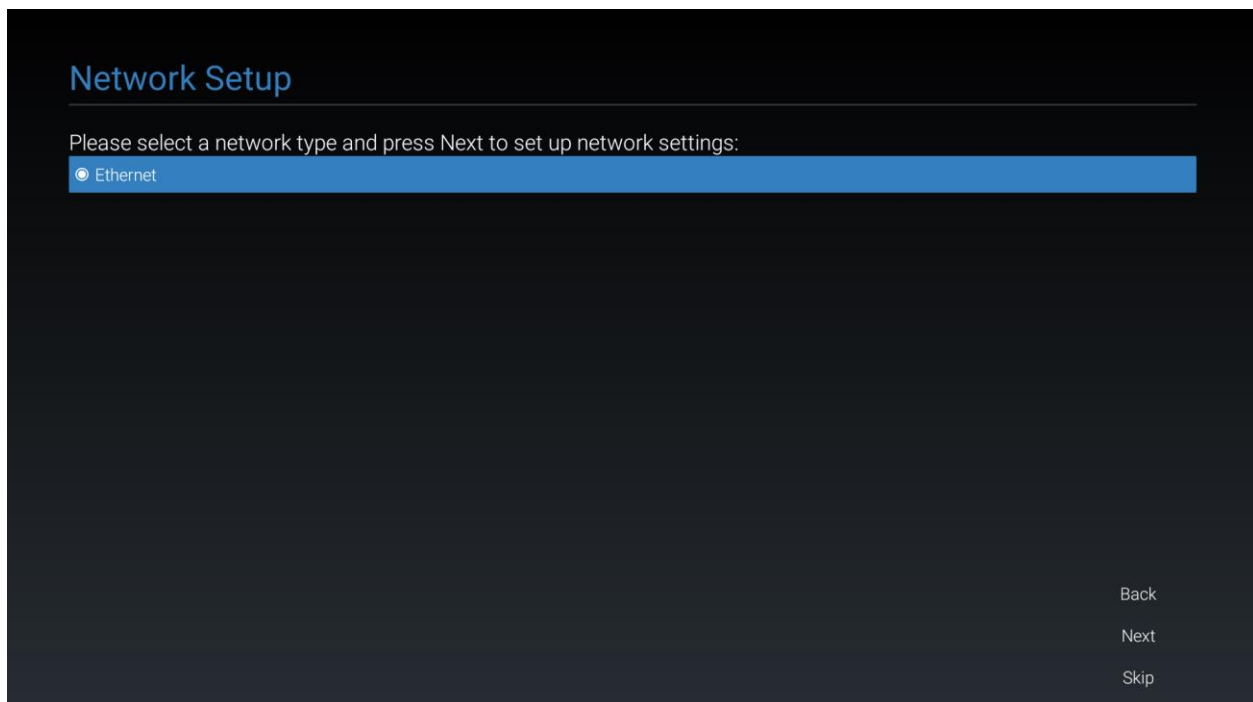

Network Setup

Please select a network type and press Next to set up network settings:

Ethernet

Back

Next

Skip

4. Otherwise, press Skip to advance to the next topic.

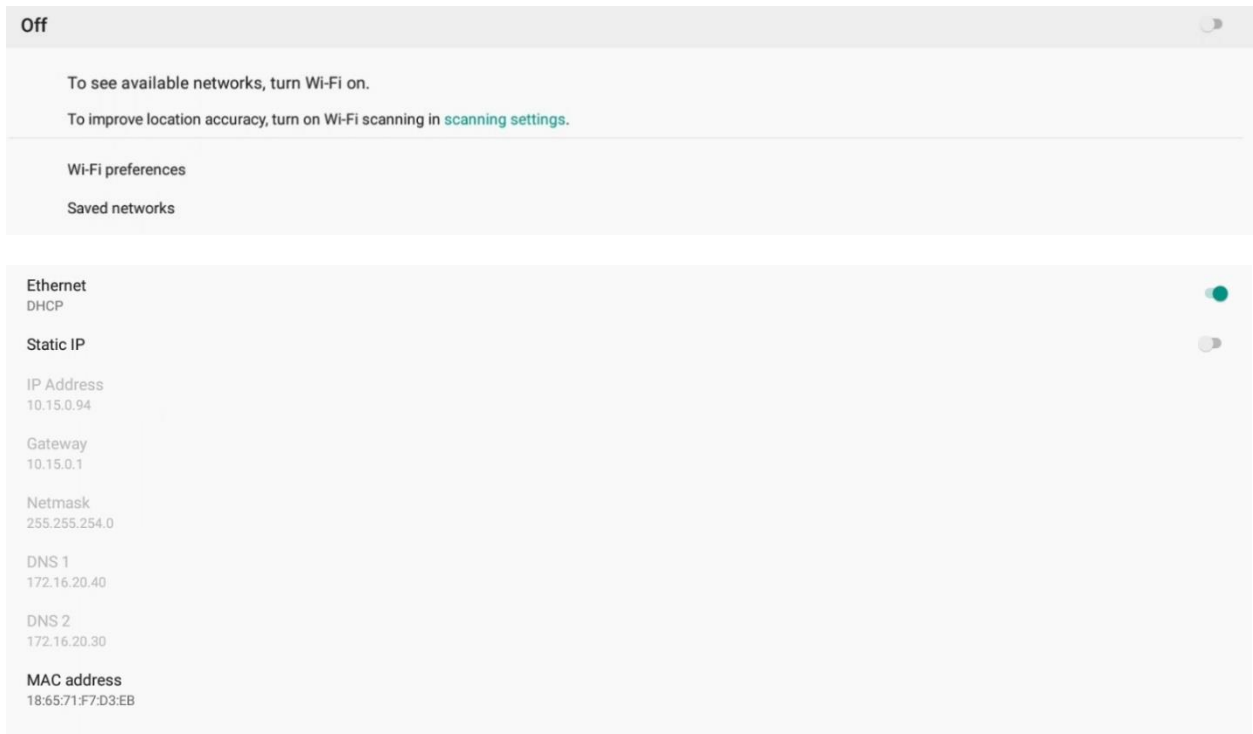

5. For Wi-Fi, select the desired network. For Ethernet, select Static IP to configure your IP settings. Press save when complete.
6. When finished, select Enable to complete setup. Press the Return key on the remote control if enabling the network connection is not desired.

Clone Media Files to Internal Storage

7. Import media files previously saved to an SD card or USB storage device using the Clone Media Files feature in the Android OSD (see page 77).

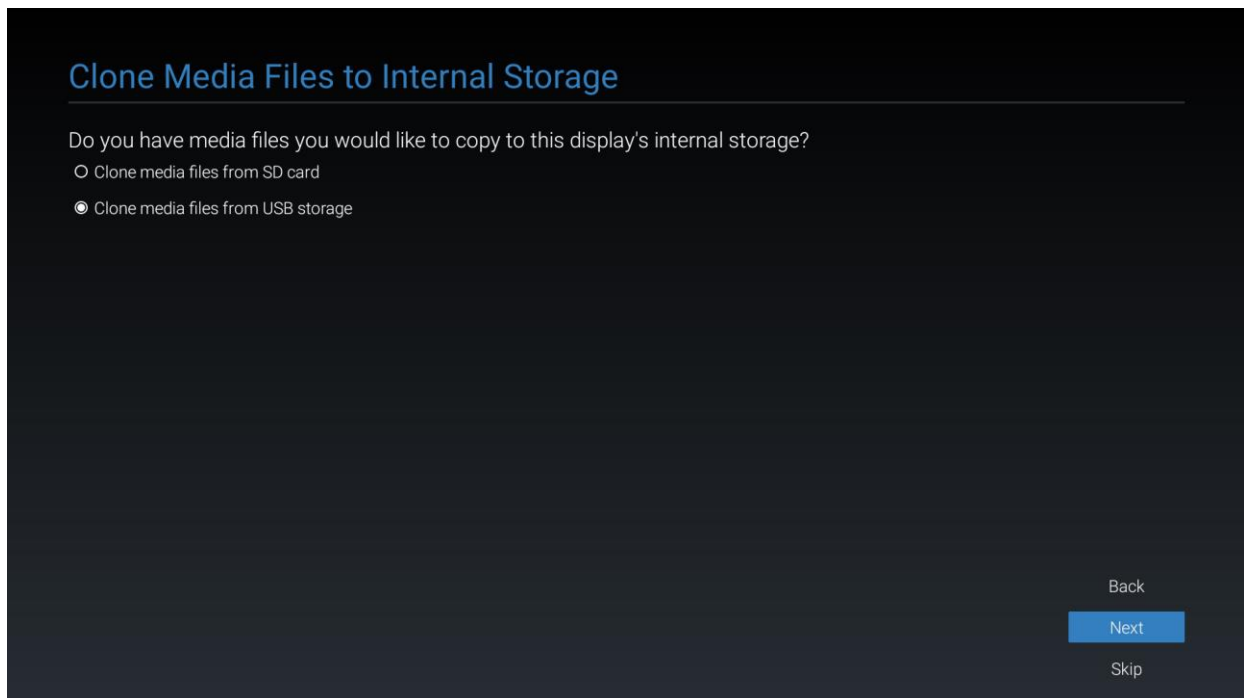

Setup Complete

8. Initial configuration is now complete. Press finish to begin using the display.

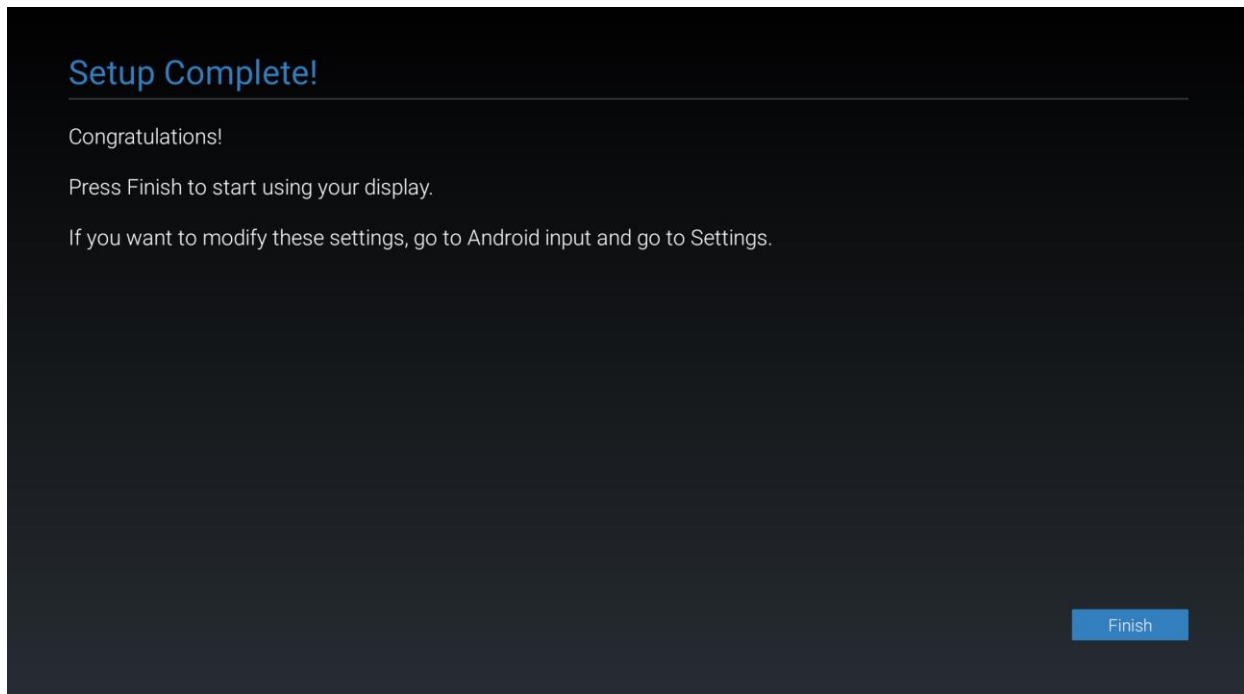

16. Input Menu

Below are the menus used for selecting the input sources for all models:

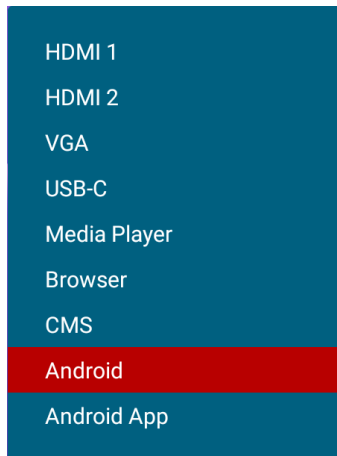

16.1 Source Options

- **Options:** HDMI 1, HDMI 2, VGA, USB-C, Media Player, Browser, CMS, Android, Android App

17. Using the Touch Screen

You can use the touch screen to control your Windows, Mac or Linux operating system. The Planar Simplicity M Series is HID compliant, delivering up to 20 points of touch on SLM432 / SLM502 / SLM552 / SLM652 / SLM752/SLM862 touch models on both Windows and Linux without a driver. Single touch only is supported for Mac operating systems. To achieve more than single touch Mac support, drivers will need to be installed, which can be found on <http://www.planar.com/support>.

Note: Ensure that you have installed the USB cable on the display to a computer and configured the Touch Routing setting appropriately. See the Touch Routing section (page 57) for USB configuration settings.

18. OSD Main Menu

18.1 Picture

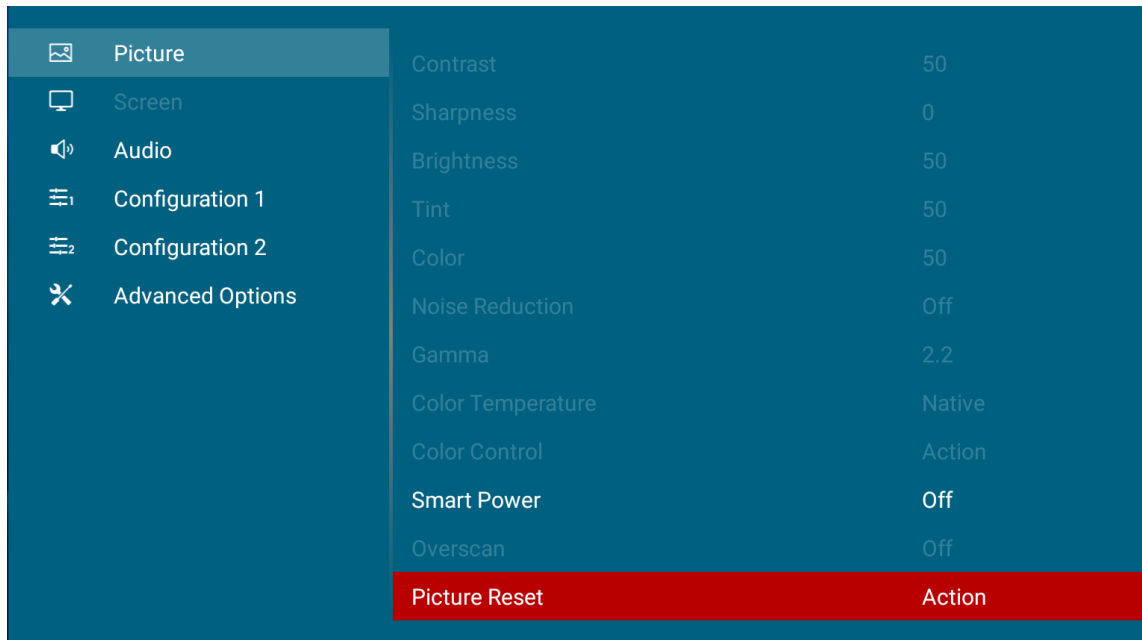

Backlight

- Increase or decrease the intensity of the LCD backlight. Press ◀ or ▶ to select the desired level.
- **Range:** 0~100
- **Default:** 80

Contrast

- Increase or decrease the contrast of the picture. Press ◀ or ▶ to select the desired level.
- **Range:** 0~100
- **Default:** 50

Sharpness

- Adjust the definition of the picture. Press ◀ or ▶ to select the desired level.
- **Range:** 0~100
- **Default:** 0

Brightness

- Increase or decrease the brightness of the picture. Press ◀ or ▶ to select the desired level.
- **Range:** 0~100
- **Default:** 50

Tint

- Increase or decrease the green hue. Press ◀ or ▶ to select the desired level
- **Range:** 0~100
- **Default:** 50

Color

- Adjust the brilliance and brightness. Press ◀ or ▶ to select the desired level
- **Range:** 0~100
- **Default:** 50

Noise Reduction

- Reduce random noise in video content
- **Options:** Options: Off, Low, Medium, High
- **Default:** Off

Gamma

- Select gamma.
- **Options:** Native, 1.8, 1.9, 2.0, 2.1, 2.2, 2.3, 2.4, 2.5, S gamma, D-image
- **Default:** 2.2

Color Temperature

- Select color temperature.
- **Options:** 3200K, 5500K, 6500K, 7500K, 9300K, 10000K, Native, User 1, User 2
- **Default:** Native

Color Control

- Red Gain
 - Adjust the amount of red in bright content. Press ◀ or ▶ to select the desired level.
 - **Range:** 0~255
 - **Default:** 128
- Green Gain
 - Adjust the amount of green in bright content. Press ◀ or ▶ to select the desired level.
 - **Range:** 0~255
 - **Default:** 128
- Blue Gain
 - Adjust the amount of blue in bright content. Press ◀ or ▶ to select the desired level.
 - **Range:** 0~255
 - **Default:** 128



Smart Power

- Automatically adjust the image settings in order to reduce power consumption
- **Options:** Off, Medium, High
- **Default:** Off

Overscan

- Adjust the zoom (overscan) of the image.
- **Options:** Off, On
- **Default:** Off

Picture Reset

- Reset all setting in the Picture menu to their default values.

18.2 Screen

Picture	H Position	50
Screen	V Position	50
Audio	Tracking	100
Configuration 1	Phase	78
Configuration 2	Aspect Ratio	Custom
Advanced Options	Custom Zoom	Action
	Auto Adjust	Action
	Screen Reset	Action

H Position

- Adjust the horizontal position of the image (VGA source only). Press ◀ or ▶ to select the desired level.
- **Range:** 0~100
- **Default:** 50

V Position

- Adjust the vertical position of the image (VGA source only). Press ◀ or ▶ to select the desired level.
- **Range:** 0~100
- **Default:** 50

Tracking

- Adjust the clock of the displayed signal (VGA source only). Press ◀ or ▶ to select the desired level.
- **Range:** 0~100
- **Default:** 50

Phase

- Adjust the phase of the displayed signal (VGA source only). Press ◀ or ▶ to select the desired level.
- **Range:** 0~100
- **Default:** 50

Aspect Ratio

- Adjust the aspect ratio of the screen.
- **Options:** Fill, 4:3, Native, 21:9, Custom
- **Default:** Fill

Custom Zoom	
Zoom	0
H Zoom	0
V Zoom	0
H Position	50
V Position	50

Custom Zoom

- Zoom
 - Adjust the zoom (overscan) of the image. Available when Aspect Ratio is set to Custom. Press ◀ or ▶ to select the desired level.
 - **Range:** 0~100
 - **Default:** 0
- H Zoom
 - Adjust the zoom (overscan) of the image in the horizontal direction only. Available when Aspect Ratio is set to Custom. Press ◀ or ▶ to select the desired level.
 - **Range:** 0~100
 - **Default:** 0
- V Zoom
 - Adjust the zoom (overscan) of the image in the vertical direction only. Available when Aspect Ratio is set to Custom. Press ◀ or ▶ to select the desired level.
 - **Range:** 0~100
 - **Default:** 0
- H Position
 - Adjust the horizontal position of the image (VGA source only). Available when Aspect Ratio is set to Custom. Press ◀ or ▶ to select the desired level.
 - **Range:** 0~100
 - **Default:** 50
- V Position
 - Adjust the vertical position of the image (VGA source only). Available when Aspect Ratio is set to Custom. Press ◀ or ▶ to select the desired level.
 - **Range:** 0~100
 - **Default:** 50

Auto Adjust

- Force the display to reacquire and lock to the input signal (VGA source only). This is useful when the signal quality is marginal.
- **Note:** This feature does not continually reacquire the signal.

Screen Reset

- Reset all settings in the Screen menu to their default values.

18.3 Audio

Picture	Balance	50
Screen	Treble	50
Audio	Bass	50
Configuration 1	Volume	20
Configuration 2	Audio Out (Line Out)	20
Advanced Options	Maximum Volume	100
	Minimum Volume	0
	Mute	Off
	Audio Reset	Action
	Audio Out Sync	Off
	Internal Speaker	On

Balance

- Adjust the balance of the left and right speakers. Press ◀ or ▶ to select the desired level.
- **Range:** 0~100
- **Default:** 50

Treble

- Adjust the sound in high tones. Press ◀ or ▶ to select the desired level.
- **Range:** 0~100
- **Default:** 50

Bass

- Adjust the sound in low tones. Press ◀ or ▶ to select the desired level.
- **Range:** 0~100
- **Default:** 50

Volume

- Adjust the sound. Press ◀ or ▶ to select the desired level.
- **Range:** 0~100
- **Default:** 20

Audio Out (Line Out)

- Adjust the sound on the L/R audio outputs. Available if Audio Out Sync is set to Off. Press ◀ or ▶ to select the desired level.
- **Range:** 0~100
- **Default:** 20

Maximum Volume

- Limit the maximum value of the Volume control. Press ◀ or ▶ to select the desired level
- **Range:** 0~100
- **Default:** 100

Minimum Volume

- Limit the minimum value of the Volume control. Press ◀ or ▶ to select the desired level
- **Range:** 0~100
- **Default:** 0

Mute

- Turn off the sound.
- **Options:** Off, On
- **Default:** Off

Audio Reset

- Reset all settings in the Audio menu to their default values.

Audio Out Sync

- Choose whether the internal speakers and audio out use the same volume control, or separate controls.
- **Options:** Off, On
- **Default:** Off

Internal Speaker

- Select the audio source to play through the display's internal speakers and audio outputs
- **Options:** Off, On
- **Default:** On

18.4 Configuration 1

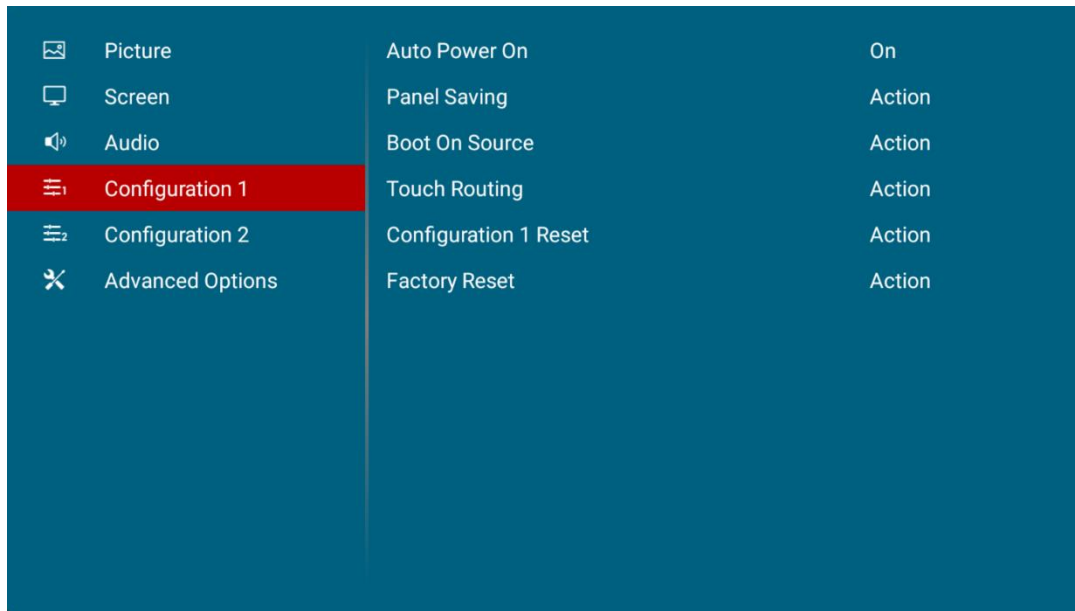

Auto Power On

- Select the behavior of the display when AC power is turned on
- **Options:** On, Off, Last Status
- **Default:** On

Panel Saving

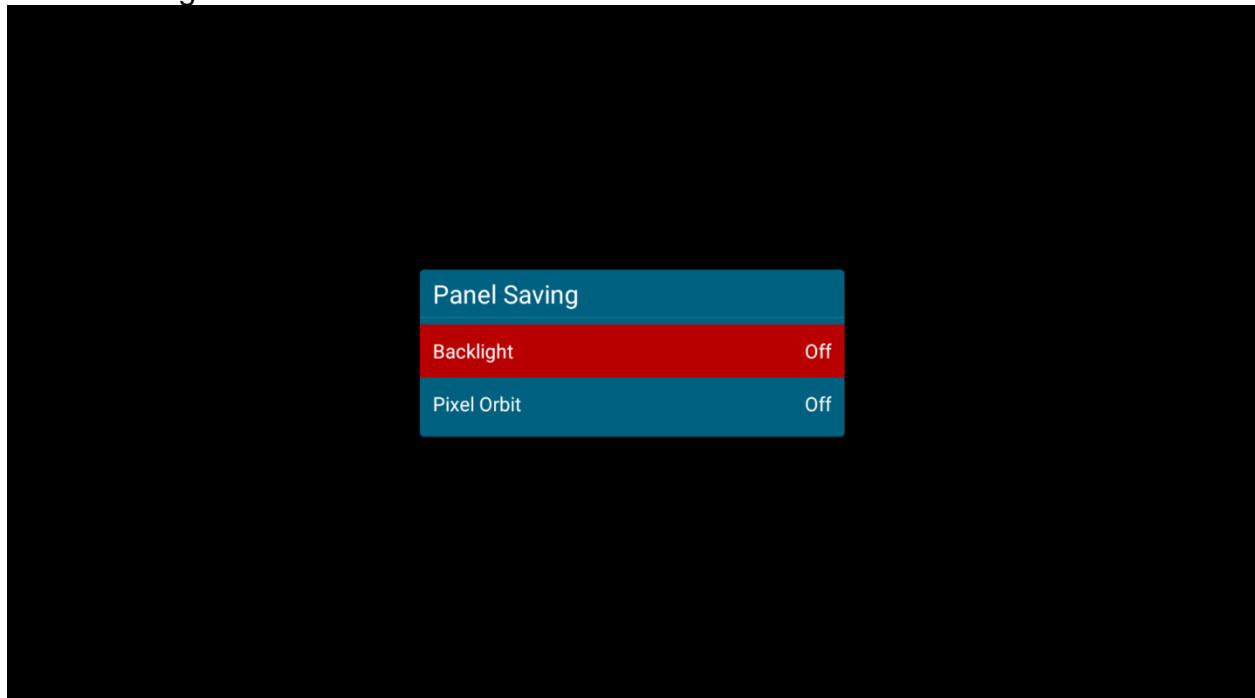

- Brightness
 - Automatically limit the backlight intensity in order to reduce power consumption
 - **Options:** Off, On
 - **Default:** Off

- Pixel Orbit
 - Create slight frame motion to help avoid image retention. Adjust how often the frame is shifted in seconds. Auto will shift the frame every 60 seconds.
 - **Options:** Off, Auto, 10~900
 - **Default:** Off

Boot On Source

Boot On Source	
Last Input	<input checked="" type="checkbox"/>
Input	HDMI 2 ▼
Playlist	0 ▼
<input type="button" value="Cancel"/> <input type="button" value="Save"/>	

Input

- Select the source to display on power up.
- **Options:** Last Input, HDMI 1, HDMI 2, VGA, USB-C, Media Player, Browser, CMS, Android, Android App
- **Default:** Last Input

Playlist

- Select the media player playlist to play at power up, if the Media Player source is selected as the power up input.
- **Options:** 0-7
- **Default:** 0

Touch Routing

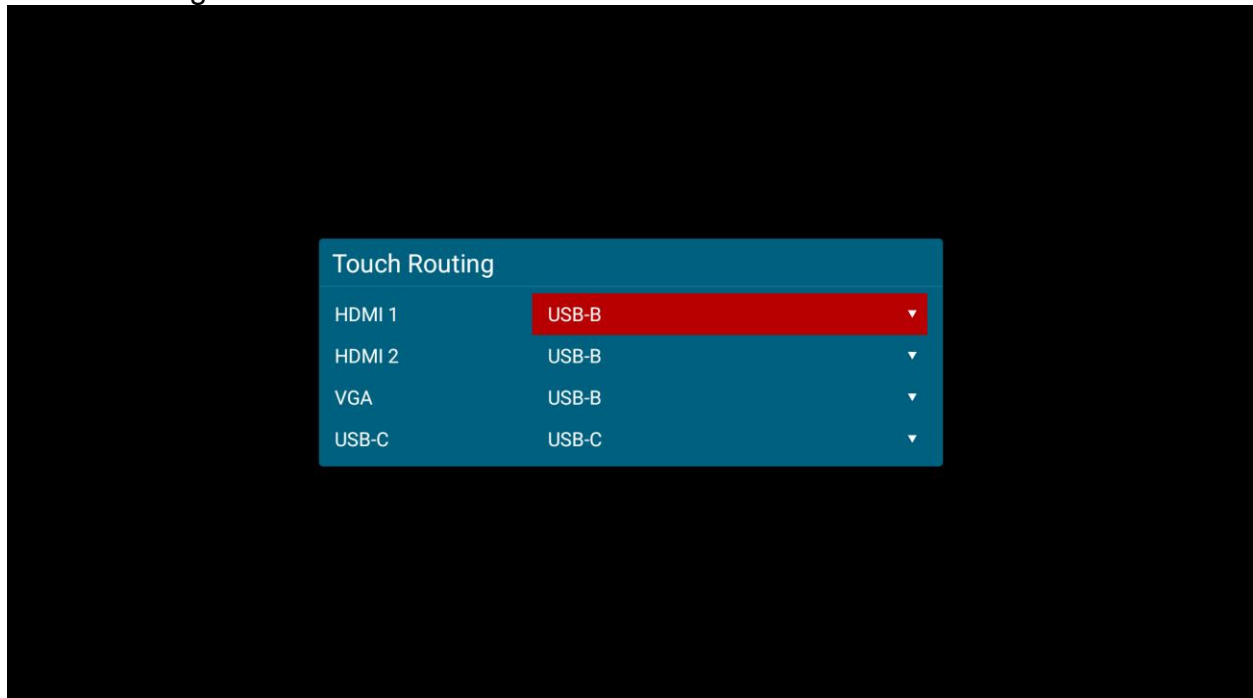

- Select which USB port to control touch for each input source.
- **Options:** USB-B, USB-C
- **Defaults:**
 - HDMI 1: USB-B
 - HDMI 2: USB-B
 - VGA: USB-B
 - USB-C: USB-C

Configuration 1 Reset

- Reset all settings in the Configuration 1 menu to their default values.

Factory Reset

- Reset all settings in all menus to their default values.

18.5 Configuration 2

Picture	OSD Timeout	45
Screen	OSD H Position	50
Audio	OSD V Position	50
Configuration 1	Information OSD Timeout	10
Configuration 2	Splash Screen	On
Advanced Options	Monitor ID	1
	Thermal Status	70.00°C 158.00°F
	Monitor Information	Action
	HDMI Version	2.0
	RGB Range	Auto
	Configuration 2 Reset	Action

OSD Timeout

- Adjust the time in seconds before the OSD menu disappears. Press ◀ or ▶ to select the desired level.
- **Range:** Off, 5~120 seconds
- **Default:** 45

OSD H Position

- Adjust the horizontal position of the OSD menu. Press ◀ or ▶ to select the desired level.
- **Range:** 0~100
- **Default:** 50

OSD V Position

- Adjust the vertical position of the OSD menu. Press ◀ or ▶ to select the desired level.
- **Range:** 0~100
- **Default:** 50

OSD Rotation

- Select the OSD orientation. This setting is only available on the following inputs: Media Player, Browser, CMS, Android, Android App.
- **Range:** Landscape, Portrait
- **Default:** Landscape
- **Note:** The Simplicity M Series does not support installing the panel in portrait orientation.

Information OSD Timeout

- Select whether the information message box displays on the screen, and for how long. Press ◀ or ▶ to select the desired level.
- Options: Off, 1~60 seconds
- Default: 10

Splash Screen

- Select whether a splash screen appears when the monitor powers up.
- **Options:** Off, On, User
- **Default:** On
- **Note:** Refer to “Creating a Custom Splash Screen Logo” on page 85 for more information.

Monitor ID

- Select the ID code to use with an IR remote control in ID mode. See page 36 for more info. Press ◀ or ▶ to select the desired level.
- **Options:** 1~255
- **Default:** 1

Thermal Status

- Read the internal temperature of the display

Monitor Information

- This read-only menu provides information on the display and its firmware version

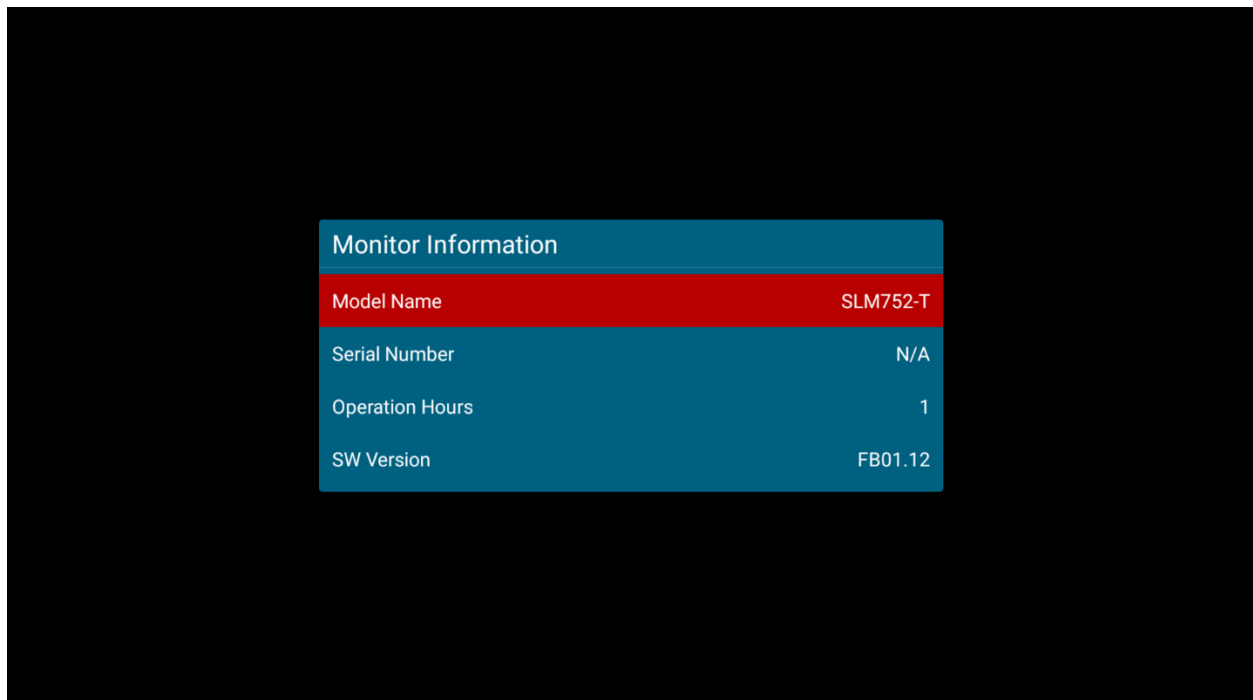

HDMI Version

- Select the HDMI version of the HDMI inputs
- **Options:** 1.4, 2.0
- **Default:** 2.0
- **Note:** HDMI 2.0 is the more modern standard and supports 3840x2160 @ 60Hz resolution. However, sometimes HDMI 1.4 is needed for compatibility with older devices.







RGB Range

- Select RGB range for HDMI and DisplayPort sources.
- **Options:** Auto, Full Range, Limited Range
- **Default:** Auto

Configuration 2 Reset

- Resets all settings in the Configuration 2 menu to their default values

18.6 Advanced Settings

	Picture	Network	Action
	Screen	IR Remote Lock	Unlock
	Audio	Status LED	On
	Configuration 1	Keypad Lock	Unlock
	Configuration 2	Off Timer	Off
	Advanced Options	Date and Time	Action
		Schedule	Action
		HDMI CEC	Off
		HDMI CEC Standby	Off
		Auto Scan Sources	Off
		Language	English
		OSD Transparency	Off

Network

- Opens the Ethernet settings menu. See page 69 for more information.

IR Remote Lock

- Lock or unlock IR remote control functionality. To disable the IR remote lock, press the Info key for 10 seconds.
- **Options:** Unlock, Lock All, Lock all but Volume, Lock All but Power, Lock All Except PWR & VOL
- **Default:** Unlock

Status LED

- Enable or disable the status LED
- **Options:** Off, On
- **Default:** On

Keypad Lock

- Lock or unlock the keypad controls
- **Options:** Unlock, Lock All, Lock all but Volume, Lock All but Power, Lock All Except PWR & VOL
- **Default:** Unlock

Off Timer

- Force the display to enter standby mode after the specified period of time. Press ◀ or ▶ to select the desired level.
- **Options:** Off, 1~24 hours
- **Default:** Off

Date and Time

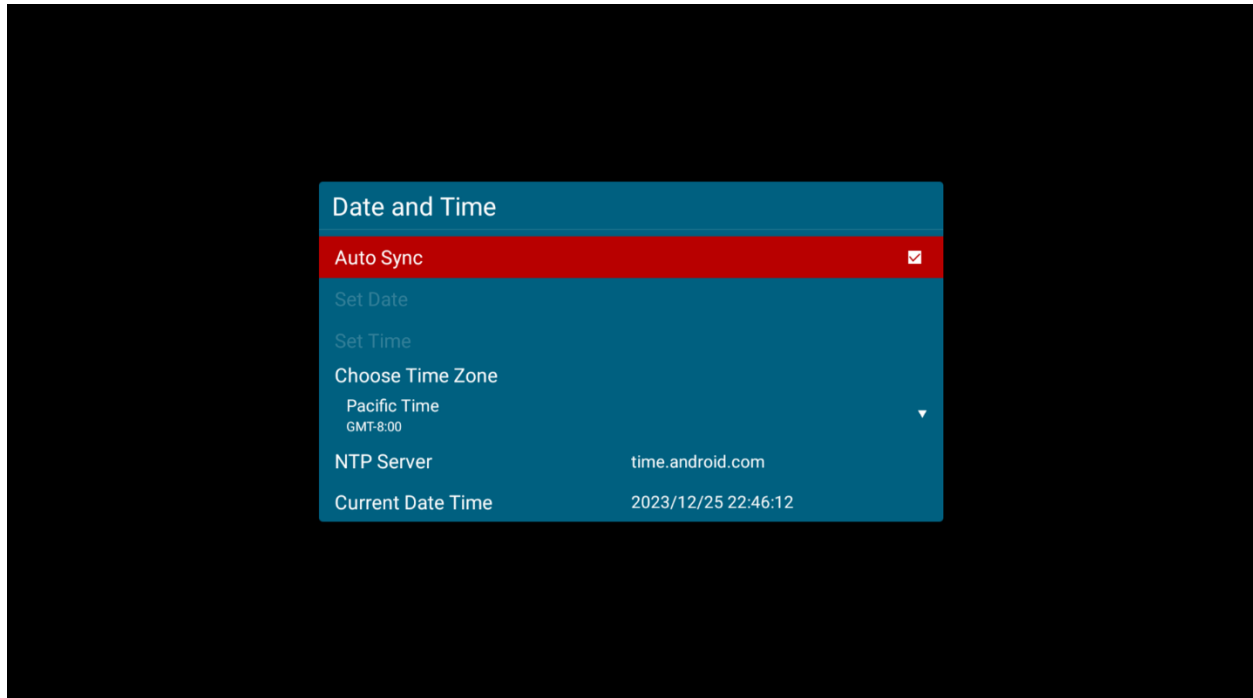

- Auto Sync
 - Automatically obtain the current date and time information from an NTP server.
 - **Options:** Off, On
 - **Default:** On
- Set Date
 - Set the current date. Available when Auto Sync is set to Off.
- Set Time
 - Set the current time. Available when Auto Sync is set to Off.
- Choose Time Zone
 - Set the current time zone
- NTP Server
 - Lists the NTP server that will be used to automatically obtain the current date and time.
- Current Date and Time
 - Displays the current date and time configured in the display.

Schedule

- This menu is used to configure schedules for powering on and powering off the display at preset times. Up to seven different schedules can be set.

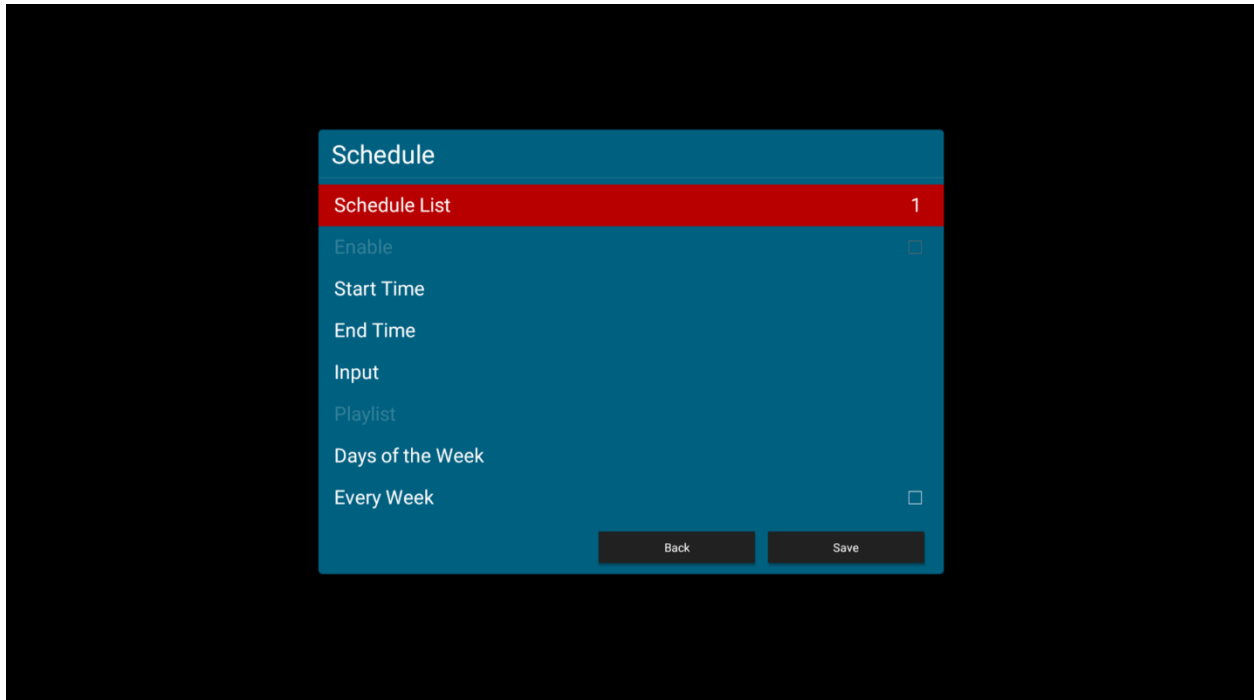

- Schedule List
 - Select the schedule preset to configure.
 - **Range:** 1~7
 - **Default:** 1
- Enable
 - Make the selected schedule active. Available when Start Time, End Time, Input, Playlist (Media Player source only) and Days of the Week are configured.
 - **Options:** Off, On
 - **Default:** Off
- Start Time
 - Set the time when the display will power on.
- End Time
 - Set the time when the display will enter standby mode.
- Input
 - Select the source to display when the unit powers on.
- Playlist
 - Select the playlist to show when the display powers on (Media Player source only).
- Days of the Week
 - Select which days of the week the selected schedule is active.
 - **Options:** Sun, Mon, Tue, Wed, Thu, Fri, Sat
 - **Default:** None
- Every Week
 - Indicate whether the schedule is for the current week only, or for every week going forward.
 - **Options:** Off, On

- **Default:** Off

HDMI CEC

- Enable HDMI CEC support on the display. The CEC commands listed in the table below are implemented:

Command	Value
Image View On	0x04
Text View On	0x0D
Standby	0x36
User Control Pressed	0x44
User Control Released	0x45
Routing Change	0x80
Active Source	0x82
Give Physical Address	0x83
Report Physical Address	0x84
Request Active Source	0x85
Give Device Power Status	0x8F
Inactive Source	0x9D
Get CEC Version	0x9F

- **Options:** Off, On
- **Default:** Off

HDMI CEC Standby

- Select whether to power off other HDMI devices via CEC when the display is powered off.
- **Options:** Off, On
- **Default:** Off

Auto Scan Sources

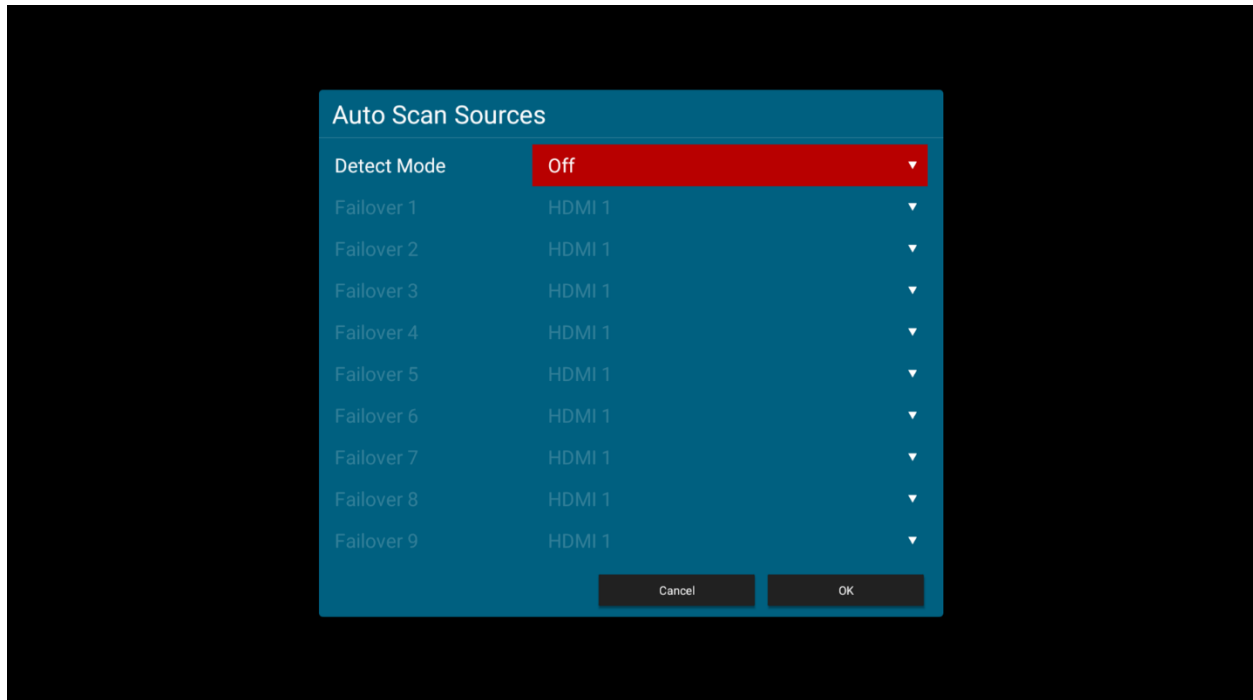

- Detect Mode
 - Automatically searches for a signal on either all inputs or selected inputs.
 - **Options:** Off, On, Failover
 - **Default:** Off
 - **Note:** The following sources are not included in the search: Media Player, Browser, CMS, Android, Android App.
- Failover 1-9
 - Select the sources to be searched if no signal is present on the main input.
 - **Options:** HDMI 1, HDMI 2, VGA, USB-C, Media Player, Browser, CMS, Android, Android App
 - **Default:** HDMI 1

Language

- Select the OSD language.
- **Options:** English, French, German, Spanish, Italian, Simplified Chinese, Traditional Chinese, Japanese, Portuguese
- **Default:** English

OSD Transparency

- Adjust the transparency of the OSD menu. Press ◀ or ▶ to select the desired level.
- **Options:** Off, 5~100 percent
- **Default:** Off

Power Down Mode

- Select the standby behavior of the display. In all Power Down Modes, the RS232 In port accepts commands, and CEC and Schedule features remain functional.
- **Options:** Standby Mode, Networked Standby Mode, Wake on Signal, Always On
- **Default:** Standby Mode
- **Standby Mode:** Achieves the lowest standby power consumption and disables network communications while in standby.
- **Networked Standby Mode:** This is the same as Standby Mode but also supports waking up the display using Wake-on-Lan (WoL).
- **Wake on Signal:** The display will enter a standby mode if no signal is detected. When a signal is restored, the display will quickly power on and show the image. Network communications will remain active.
 - **Note:** Sending an OFF command will bypass Wake On Signal detection and enter the fast startup mode like Always On.
 - **Note:** If Failover detection has been enabled, the display will automatically search for a signal on other inputs before entering standby.
- **Always On:** This is the fast startup mode. An OFF command will place the display into a standby mode with partially reduced power and network communications still active.
- **Note:** Startup time can be reduced by using **Wake On Signal** or **Always On**.

Advanced Settings Reset

- Resets all settings in the Advanced Settings menu to their default values.

19. OSD Android Settings Menu

19.1 Android Main Menu

To access the Android menu, open the Source menu and select Android.

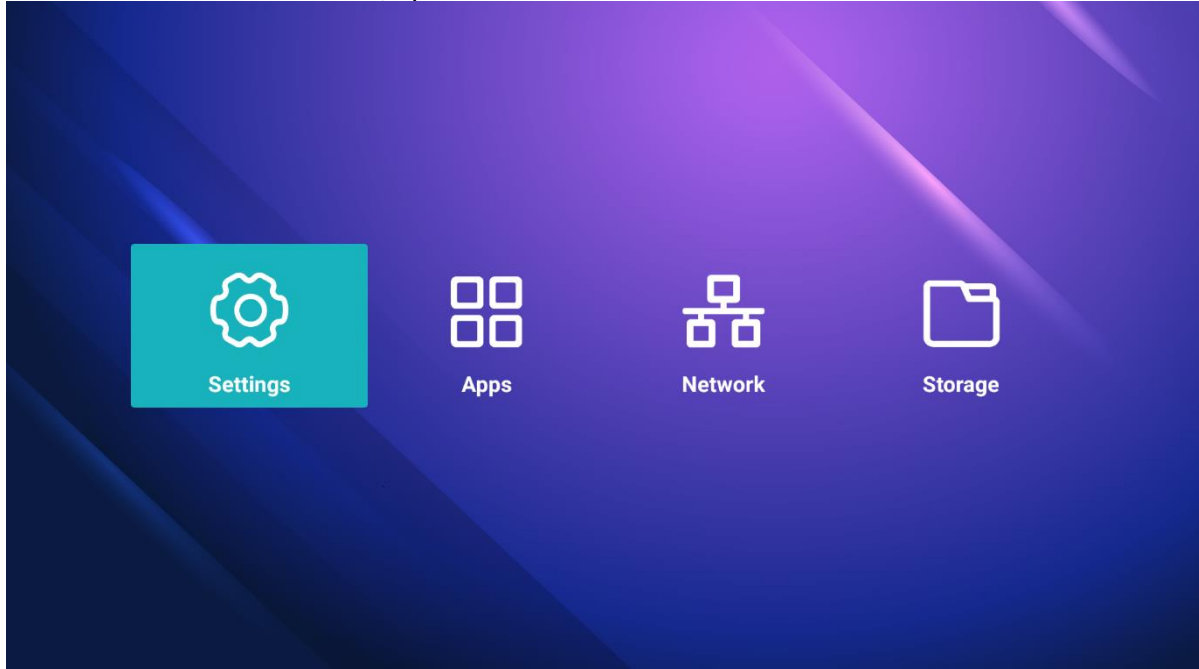

Note: In addition to the IR remote control, use a USB keyboard and mouse to navigate the Android menu and modify settings.

19.2 Settings

- Network & Internet
- Signage Display
- Apps
- Display
- Security
- System
- About

Network & Internet

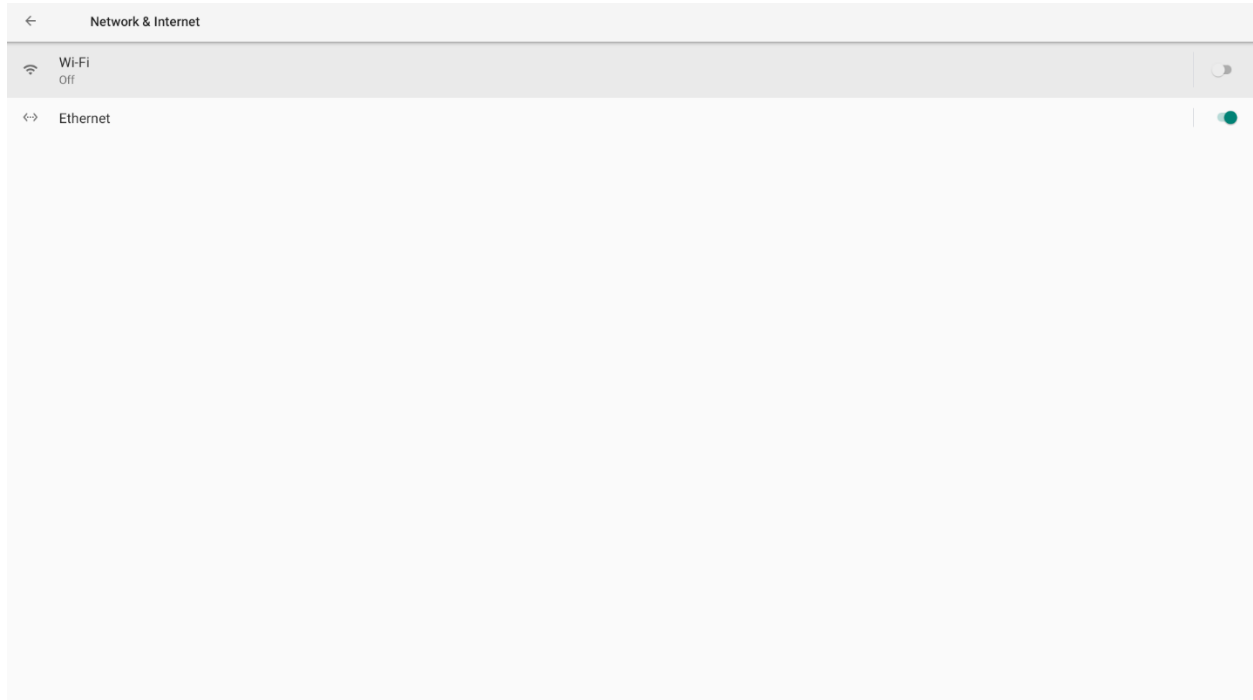

Wi-Fi

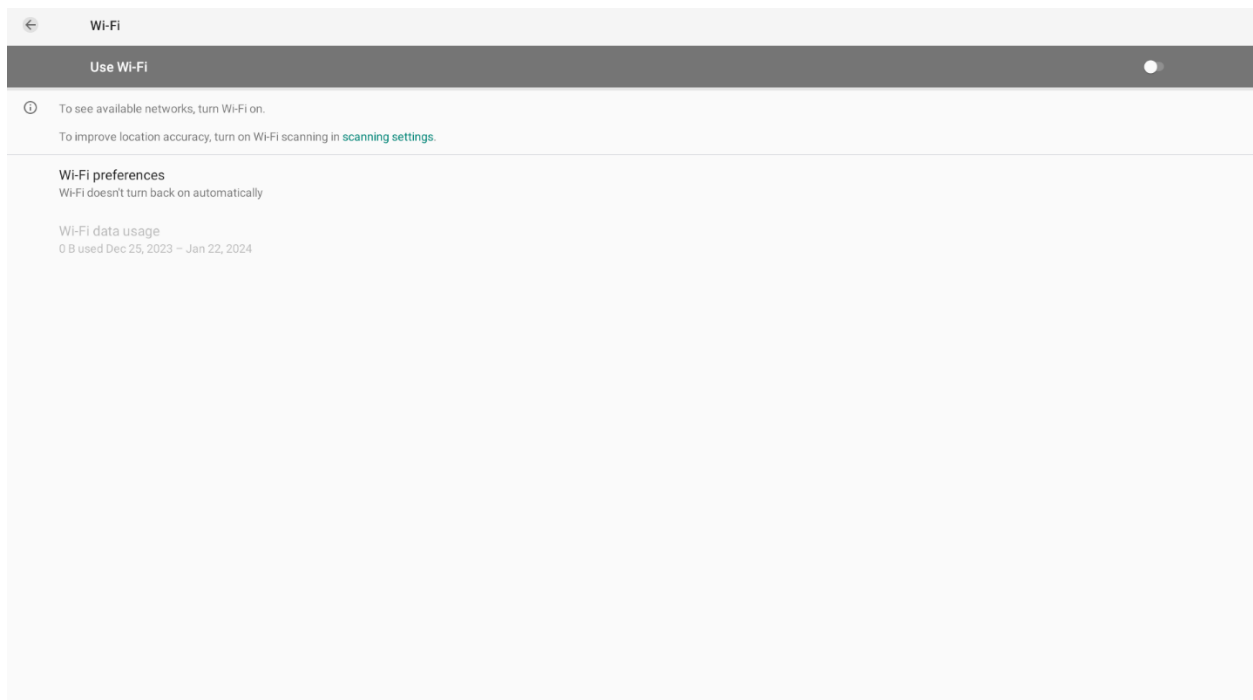

- Wi-Fi
 - Enable the Wi-Fi interface. Turn on switch at the top of the menu to enable Wi-Fi network selection.
 - **Note:** Wi-Fi support is only available with the TP-Link TL-WN725N USB adapter. Other Wi-Fi dongles are not supported at this time.

Ethernet

Ethernet	<input checked="" type="checkbox"/>
DHCP	<input type="checkbox"/>
Static IP	<input type="checkbox"/>
IP Address	10.15.0.94
Gateway	10.15.0.1
Netmask	255.255.254.0
DNS 1	172.16.20.40
DNS 2	172.16.20.30
MAC address	18:65:71:F7:D3:EB

- Ethernet
 - Enable the network interface
 - **Options:** Disable, Enable
 - **Default:** Disable
- Static IP
 - Enable dynamic IP mode or configure the static IP settings of the display's Ethernet port.
 - **Options:** Disable (use DHCP), Enable (use static IP)
 - **Default:** Disable
- IP Address
 - The IP address used by the display's network interface.
 - Configurable if Static IP is enabled.
- Gateway
 - The default gateway used by the display's network interface.
 - Configurable if Static IP is enabled.
- Netmask
 - The subnet mask used by the display's network interface.
 - Configurable if Static IP is enabled.
- DNS 1
 - The address of the primary DNS server used by the display's network interface.
 - Configurable if Static IP is enabled.
- DNS 2
 - The address of the secondary DNS server used by the display's network interface.
 - Configurable if Static IP is enabled.

- MAC Address
 - The MAC address of the display's network interface.

Signage Display

Signage Display
General Settings
Server Settings
Source Settings
Network Application
System Tools
System Updates

General Settings

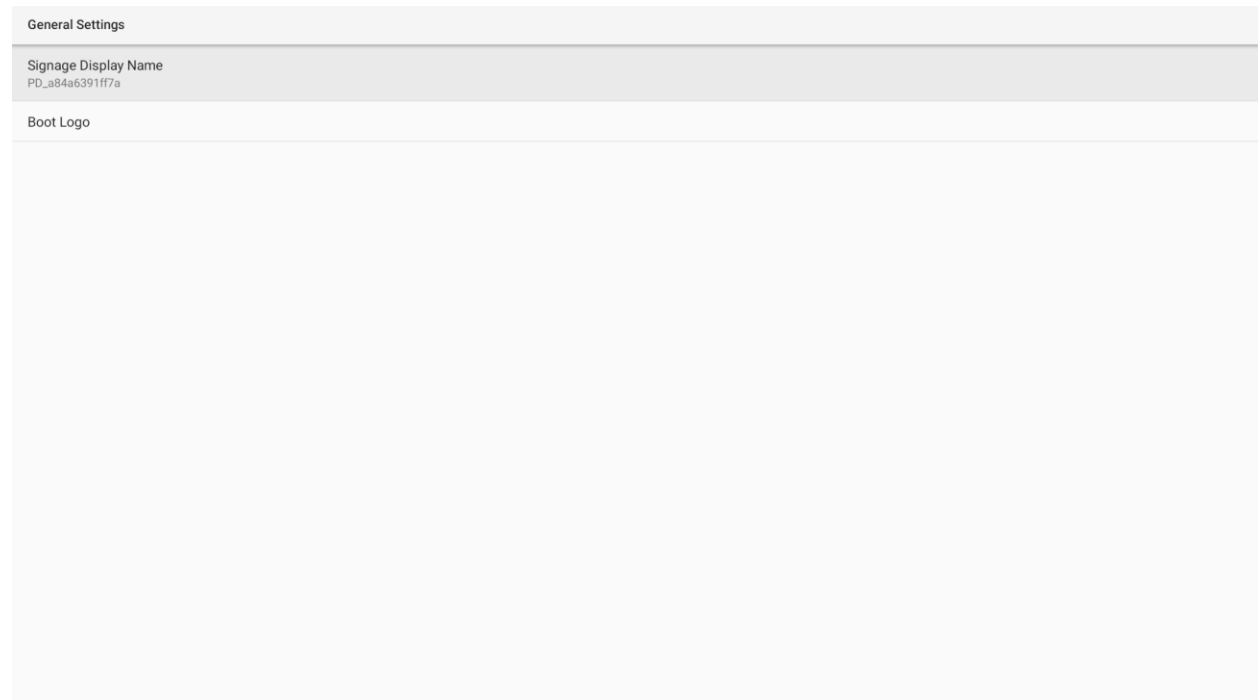

- Signage Display Name
 - Assign a name to the display. By default, this is “PD_” plus the MAC address of the display.
- Boot Logo
 - Select a boot animation to be used when the Splash Screen setting is set to User.
 - **Note:** Refer to “Creating a Custom Splash Screen Logo” on page 85 for more information.

Server Settings

Server Settings
SSH

SSH

SSH
Main Switch
Enable <input type="checkbox"/>
Disable
SSH
Account admin
Password
Port 2222

- Main Switch
 - Enable or disable SSH service. A valid password must be entered before this setting can be enabled.
 - **Options:** Enable, Disable
 - **Default:** Disable
- Account
 - Username for SSH authentication
 - **Default:** admin
 - **Password:**
 - Password for SSH authentication
 - **Port:**
 - Port for SSH connection.
 - **Default:** 2222

Source Settings

Source Settings
Media Player
Browser
Android App

- **Media Player**
 - Edit the Media Player's playlists and settings.
- **Browser**
 - Edit any saved bookmarks in the web browser.
- **Android App**
 - Select the app associated with the Android App source.
 - Default: Chromium

Network Application

- RS232 Network Port

RS232 Network Port	
<hr/>	
Main Switch	
Enable	<input checked="" type="checkbox"/>
Enable	
RS232 Network Port	
RS232 Network Port	
5000 (Connected)	

System Tools

System Tools
Clear Storage
All
Internal Storage
USB Storage
SD Card
Reset
Factory Reset
Auto Restart
Auto Restart
Import & Export
Export Signage Display Settings
Import Signage Display Settings
Clone
Clone Media Files

- Clear Storage
 - Erase all user configurable storage in the selected location.
 - **All:** Internal storage, USB storage, and SD card
 - Internal Storage
 - USB Storage
 - SD Card

- Factory Reset
 - Reset all internal storage to default values
 - **Note:** Choosing this option will cause the display to go through initial setup (see page 40).

- Export Signage Display Settings
 - Write all display settings to a USB storage device or an SD card, excluding the Signage Display Name field.
 - This allows the display's settings to copy to another unit.

- Import Signage Display Settings
 - Read all display settings from a USB storage device or an SD card, excluding the Signage Display Name field.
 - This allows the display's settings to copy from another unit.

- Clone Media Files
 - This menu allows all media files to copy from the specified location to the selected destination.

The screenshot shows a menu titled "Clone Media Files". It is divided into two sections: "Clone Source" and "Target Location".

Clone Source:

- Internal Storage
- SD Card
- USB Storage

Path:

Target Location:

- Internal Storage
- SD Card
- USB Storage

Path: Internal/planar/

At the bottom of the menu is a large button labeled "CLONE".

- Clone Source
 - The source location to copy the media files from.
 - **Options:** Internal Storage, SD Card, USB Storage
- Target Location
 - The destination to copy the media files to.
 - **Options:** Internal Storage, SD Card, USB Storage
- Clone
 - Press to start copying media. When complete, a popup completion message will appear briefly.
- System Updates
 - Initiates the firmware upgrade process. Refer to the directions in the firmware upgrade package for more information.

Apps

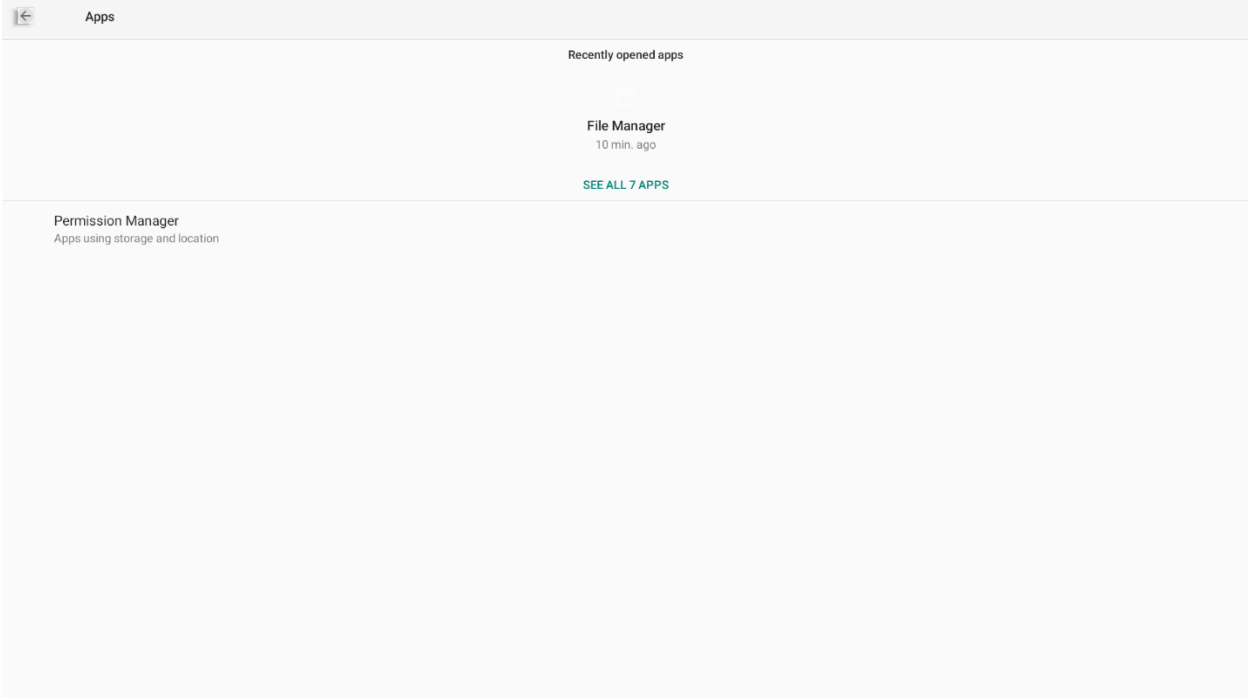

- Manage installed apps on the display.

Display

Font size

Largest

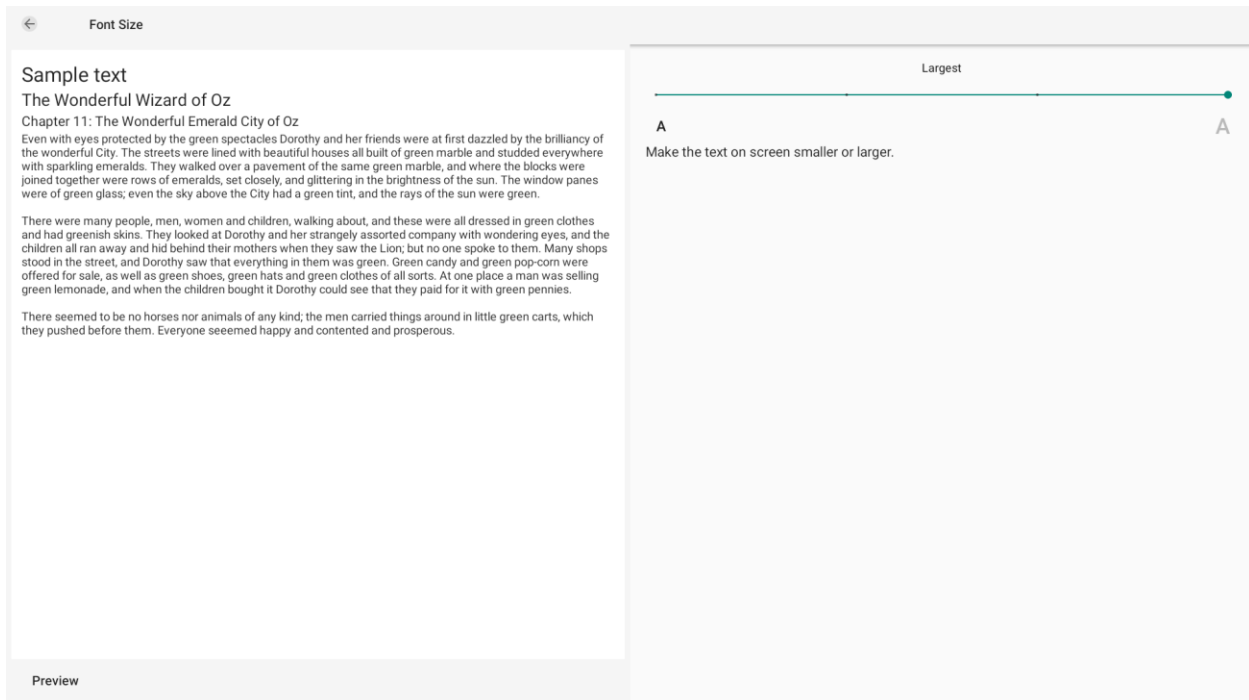

- Font Size
 - Configures the font size used in the Android menu.
 - **Options:** Small, Default, Large, Largest
 - **Default:** Largest

Security

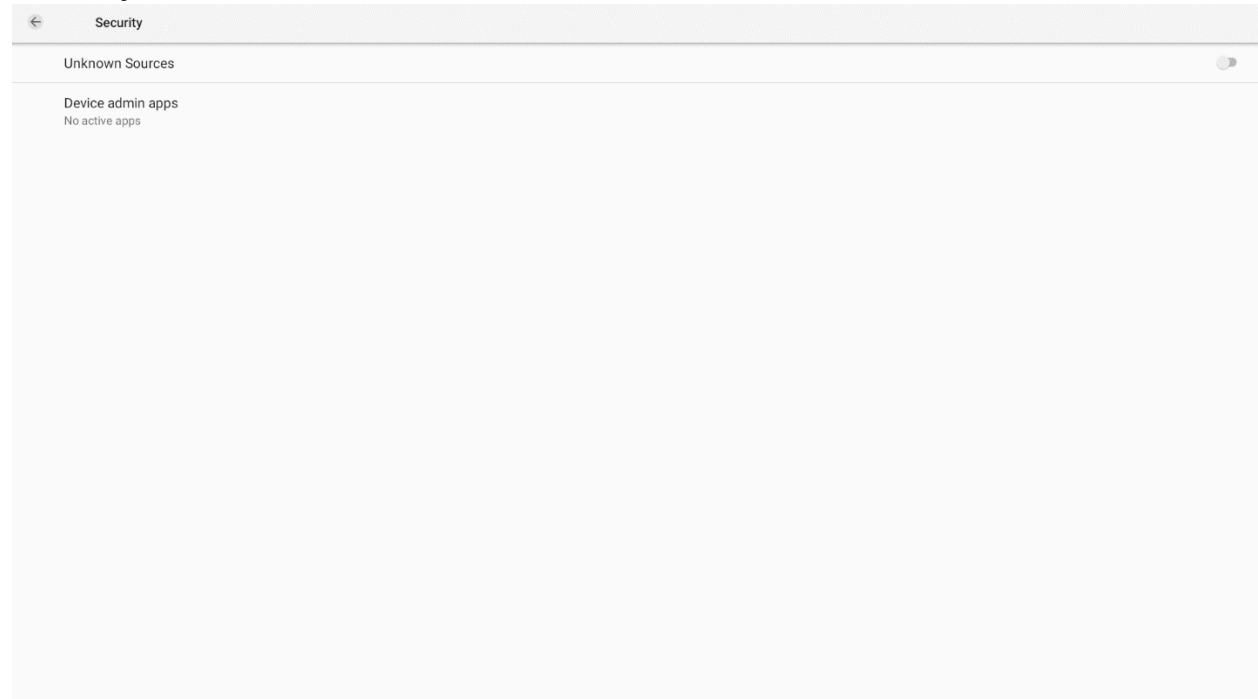

- Unknown Sources
 - Allow the installation of third party Android apps.
 - **Settings:** Disable, Enable
 - **Default:** Disable
- Device Admin Apps
 - Select an Android app to be a device administrator.

System

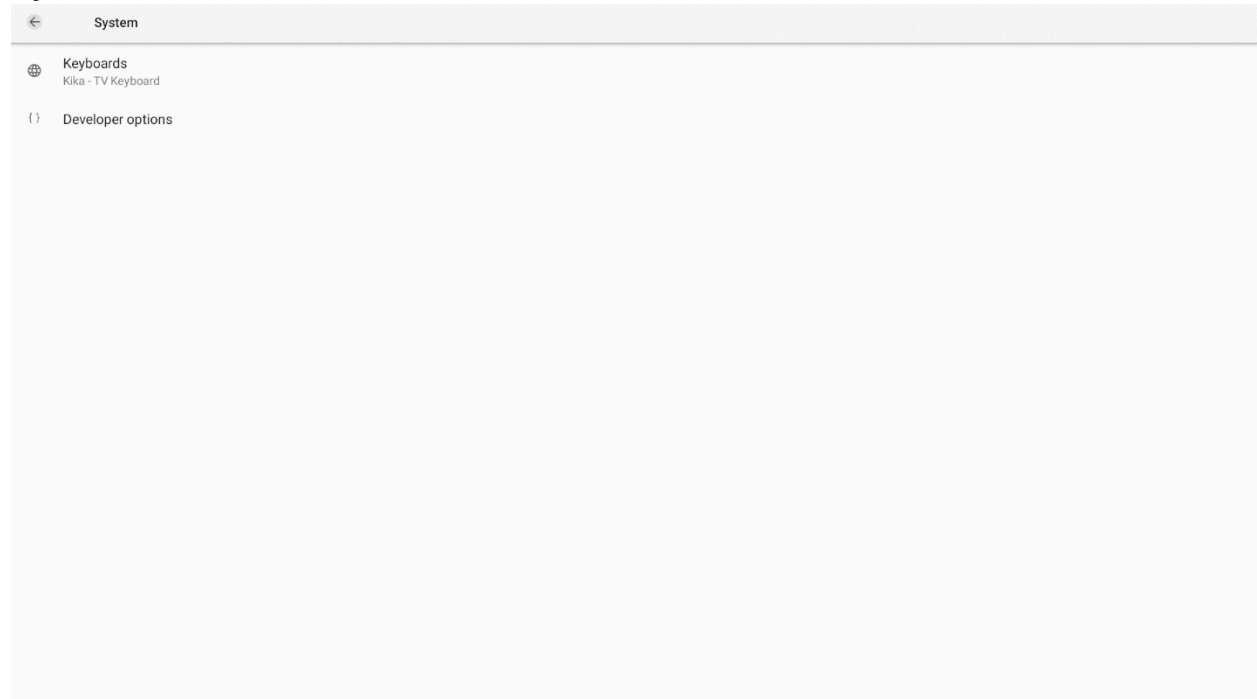

- Keyboard & Inputs
 - Configure keyboard settings.

- Developer Options
 - Android debugging controls for engineering use only.

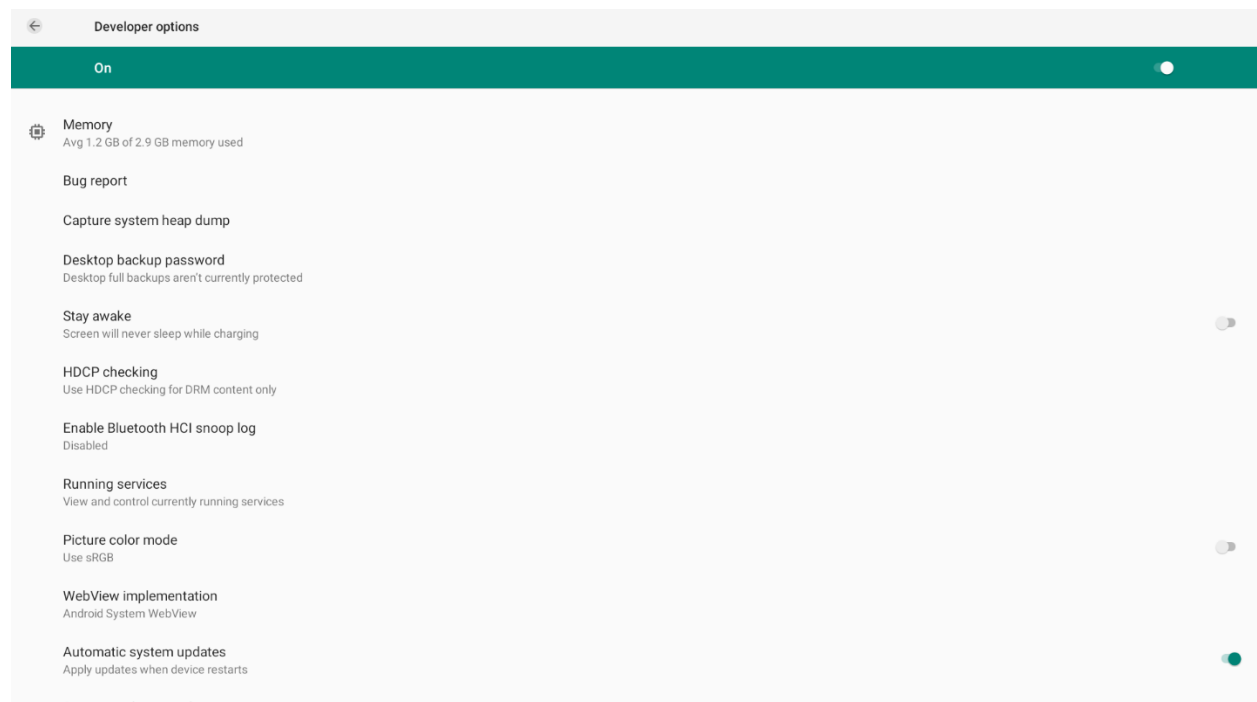

- About
 - Lists firmware version information.

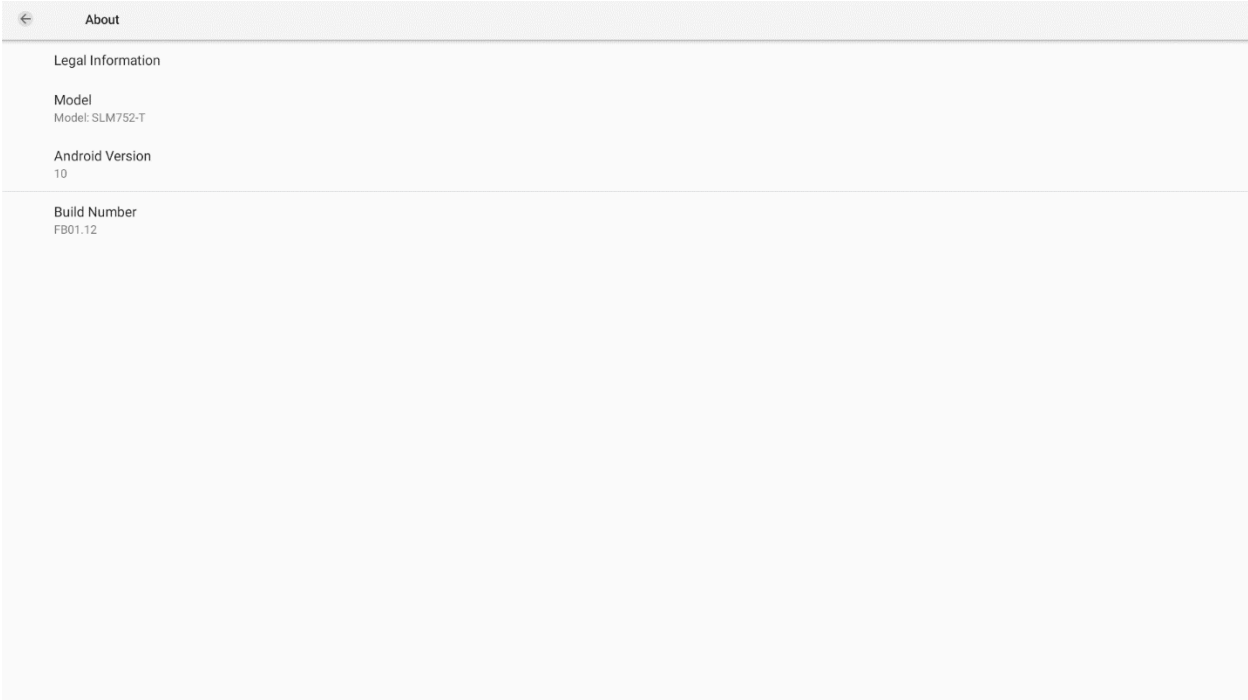

19.3 Apps

Lists pre-installed apps on the display. Select an app to run it.

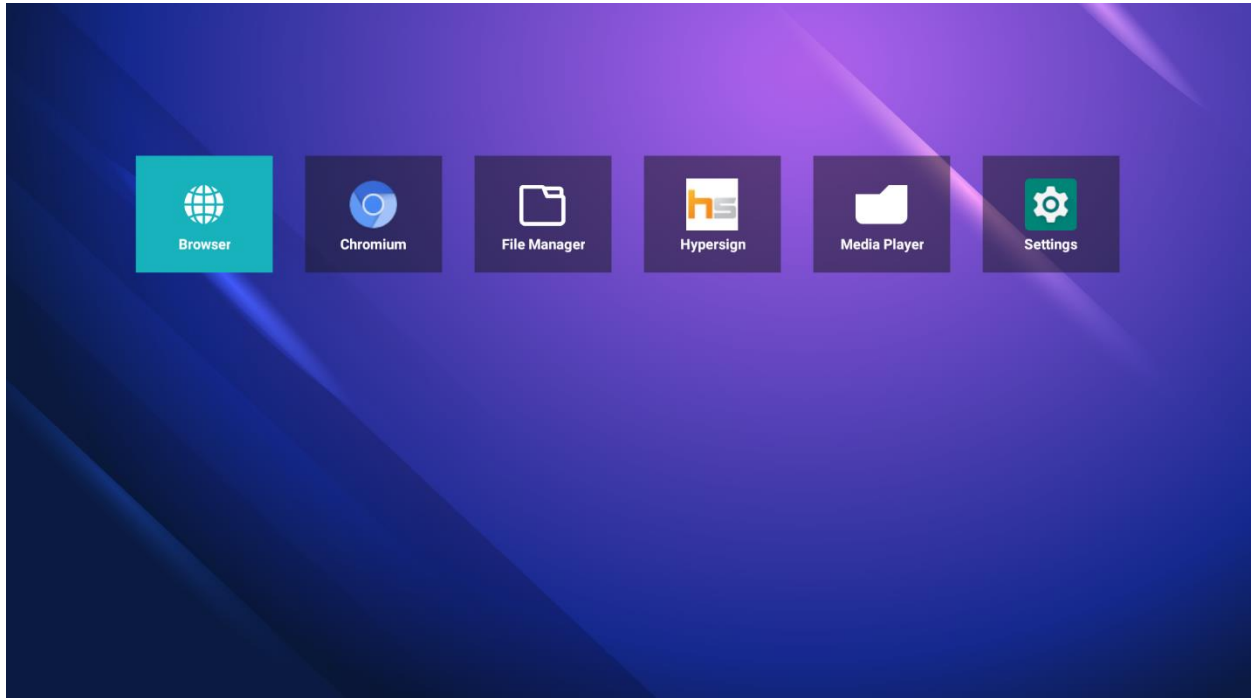

19.4 Network

Click Ok to navigate through to Ethernet menu.

See the Ethernet menu under Settings on page 69.

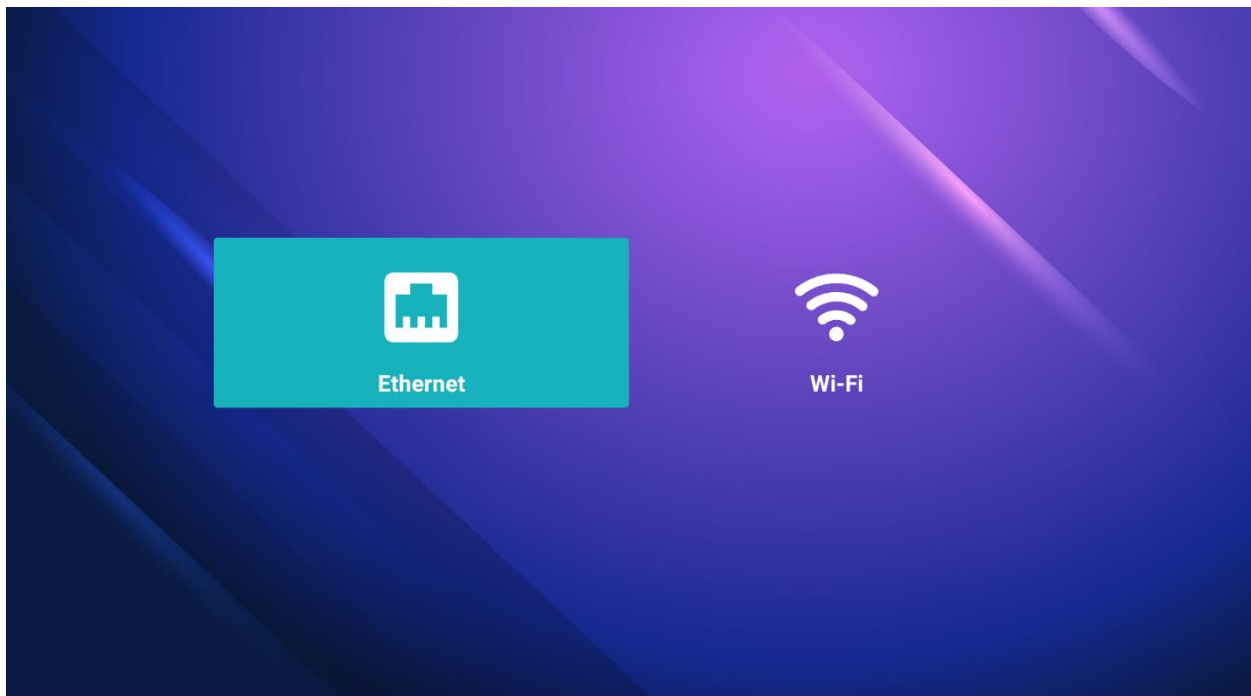

19.5 Storage

Allows management of the internal file system and any drives connected via USB.

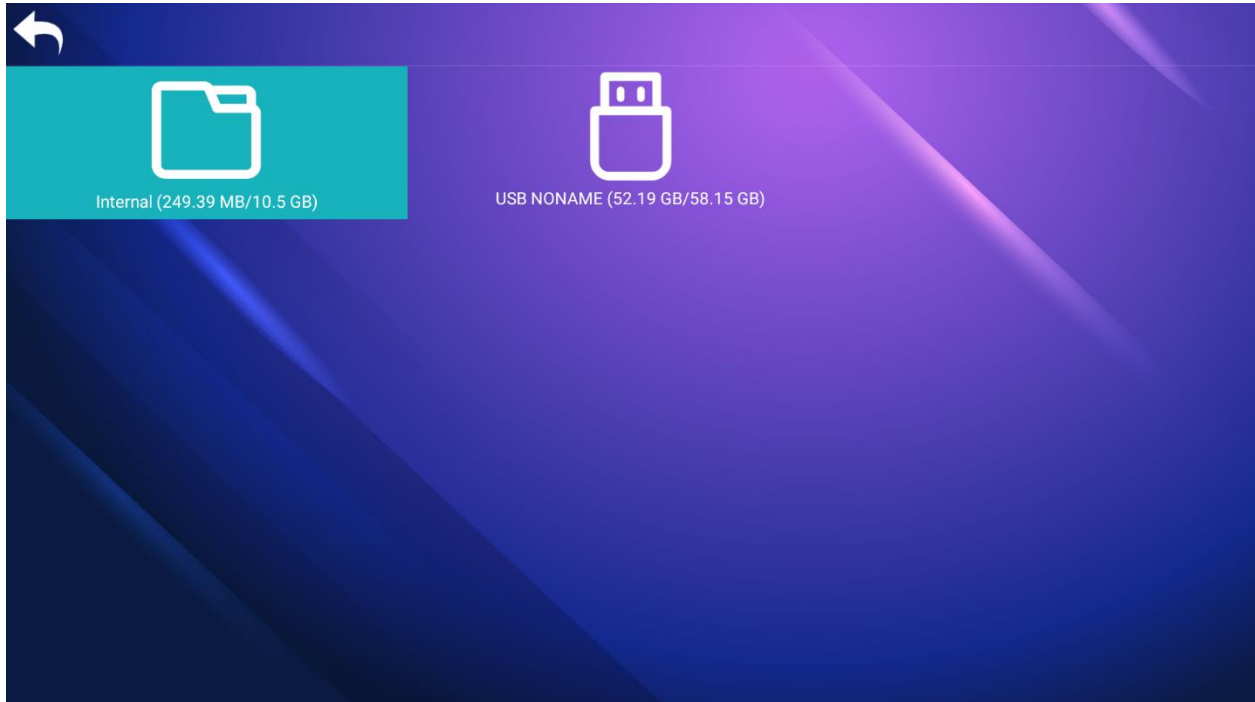

20. Creating a Custom Splash Screen Logo

1. Create a folder with the PNG file inside it to use as a logo:

- Name the folder “part0”.

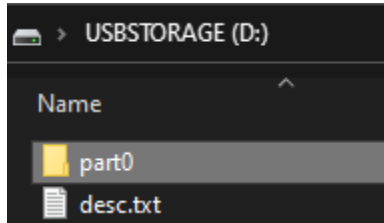

- Name the PNG file “0000” and place it inside the part0 folder.

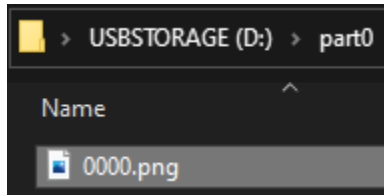

2. Create a text file for file settings:

- Name the text file “desc”.

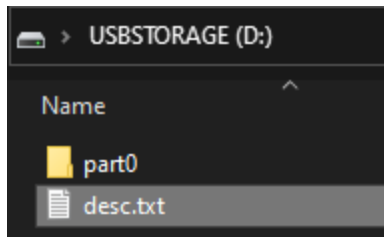

- Include these three lines in the desc text file:

Line 1: 1920 1080 30

Line 2: p 0 0 part0

Line 3:

Where Line 3 is a new blank line.

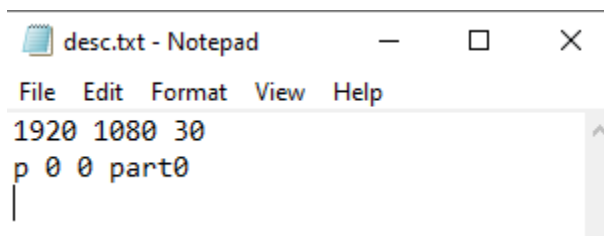

3. Create a compressed file with the “part0” folder and “desc” text file:
 - Select both files and used a program such as 7zip to compress.

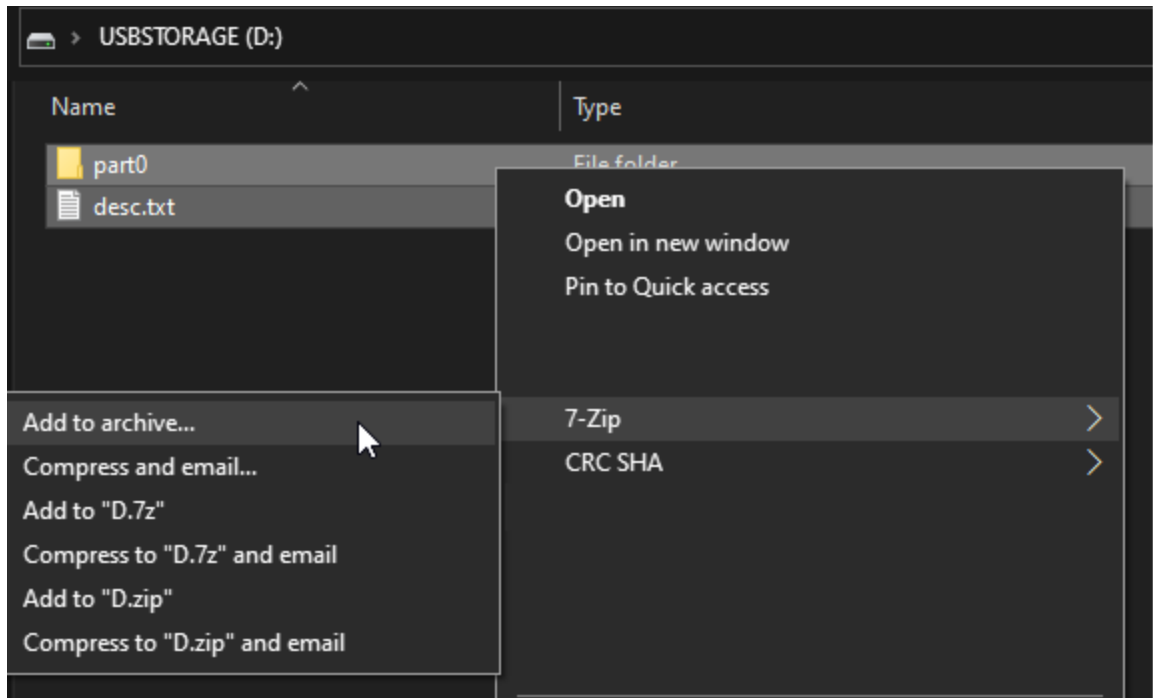

- The compression level needs to be “Store” and the Archive needs to be named “bootanimation.zip”

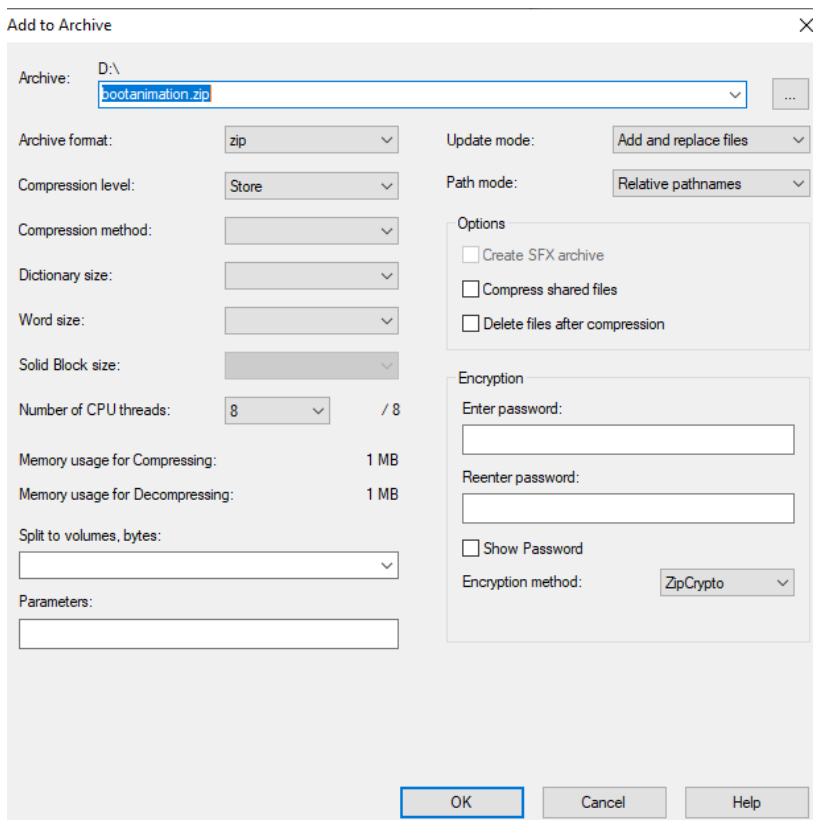

4. Place the “bootanimation.zip” folder onto a USB stick and insert it into the display.
5. Go to the display’s Menu and change the **Splash Screen** setting to **User**.

Picture	OSD Timeout	45
Screen	OSD H Position	50
Audio	OSD V Position	50
Configuration 1	Information OSD Timeout	10
Configuration 2	Splash Screen	User
Advanced Options	Monitor ID	1
	Thermal Status	84.00°C 183.20°F
	Monitor Information	Action
	HDMI Version	2.0
	RGB Range	Auto
	Configuration 2 Reset	Action





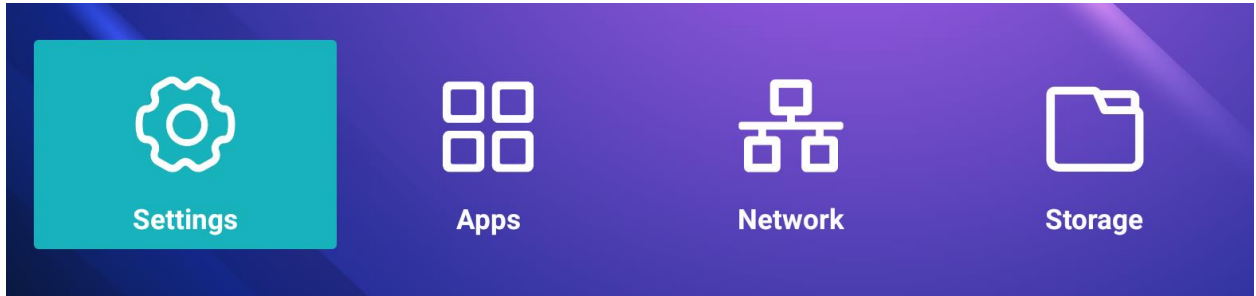

6. Change **Source** to **Android**:

HDMI 1
HDMI 2
VGA
USB-C
Media Player
Browser
CMS
Android
Android App

7. Navigate to **Settings**:



8. Select **Signage Display**.

-  Network & Internet
-  Signage Display
-  Apps
-  Display
-  Security
-  System
-  About

9. Select **General Settings**.

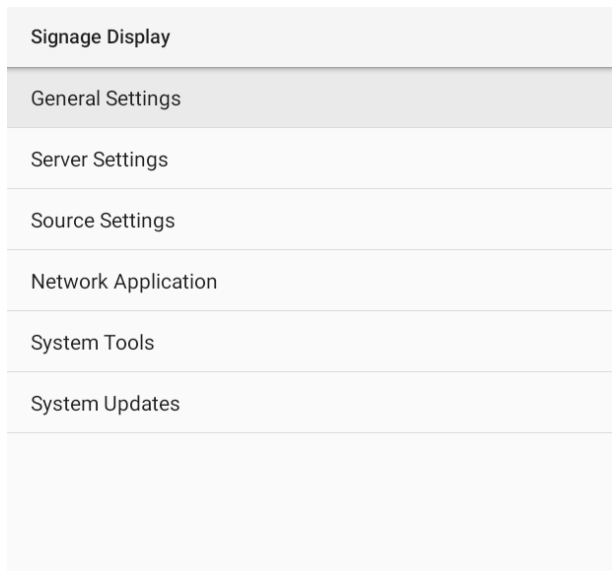

10. Select **Boot Logo**.

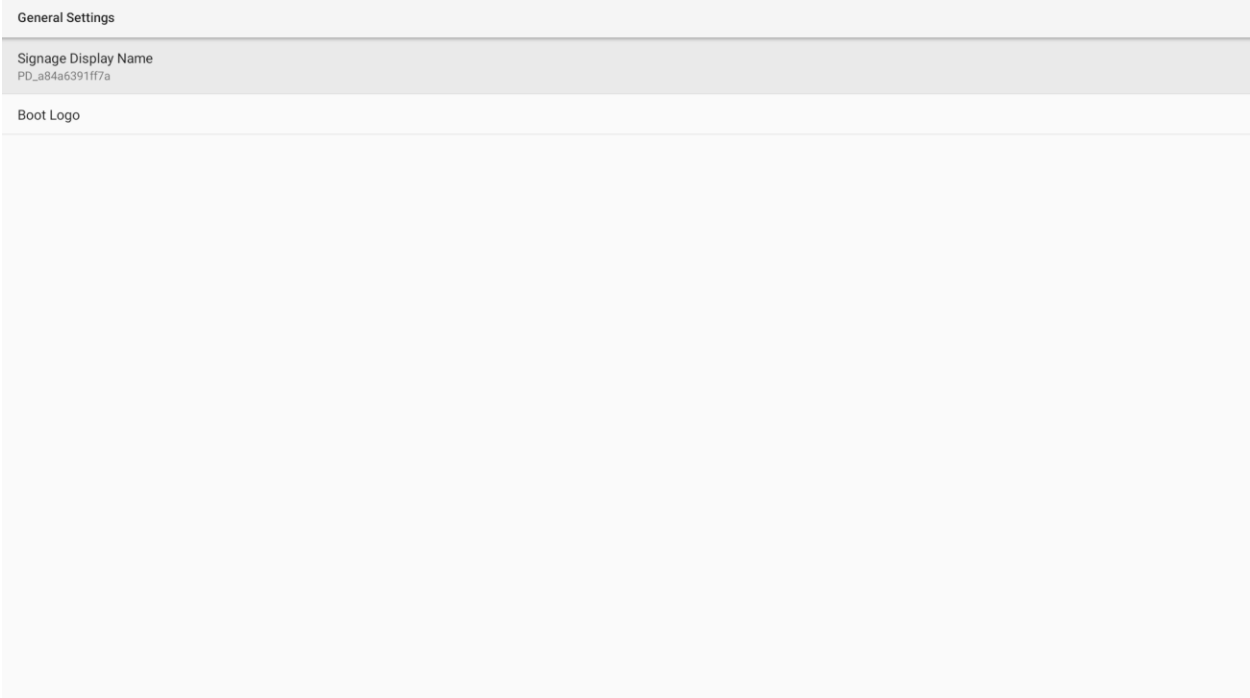

11. Select **Choose Boot Animation**.

12. Select the USB symbol with the “bootanimation.zip” folder and click **Save**.

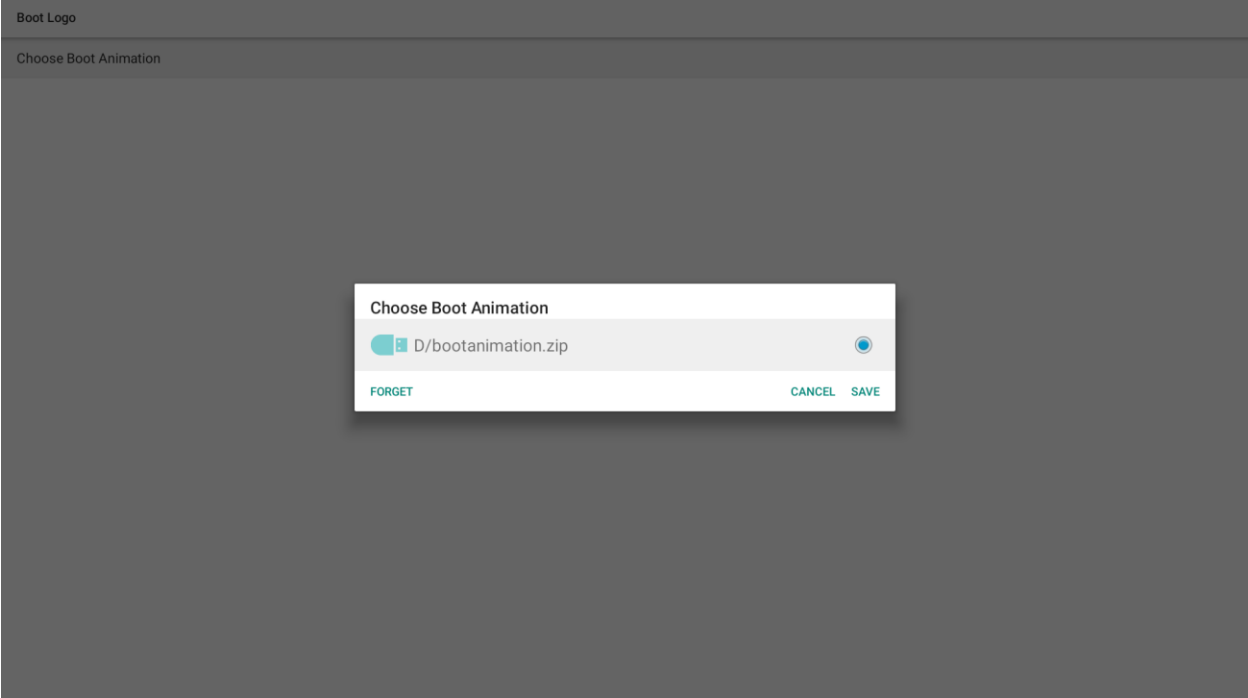

13. Test by rebooting the display.

21. Media Player

The Planar Simplicity M Series display has an embedded Media Player that can be used to play videos, photos and/or music from a USB Drive. Please see below for more information.

21.1 Supported Media Formats

The table below outline the supported media formats and compatibility for video, audio, and visual content.

Media Player Video Compatibility		
Format	File Types	Max Resolution and Bit Rate
MPEG 1/2	MPEG program stream (.dat, .vob, .mpg, .mpeg) MPEG transport stream (.ts) MP4 (.mp4, .mov) 3GPP (.3gpp, .3gp) AVI (.avi) MKV (.mkv)	1080p/30Hz 40Mbps
MPEG 4	MP4 (.mp4) AVI (.avi) MKV (.mkv)	1080p/30Hz 40Mbps
H.263	FLV (.flv) AVI (.avi)	1080p/30Hz 40Mbps
H.264	FLV (.flv) MP4 (.mp4) MPEG transport stream (.ts) AVI (.avi) MKV (.mkv)	4K/60Hz 135Mbps
H.265	MP4 (.mp4, .mov) MPEG transport stream (.ts) MKV (.mkv)	4K/60Hz 100Mbps
Google VP8	MKV (.mkv) WebM (.webm)	1080p/30Hz 50Mbps

Media Player Audio Compatibility		
Format	File Types	Max Bit Rate and Sampling Rate
MPEG Audio (MPEG 1/2/2.5 Audio Layer 1/2/3)	MP3	8-448 Kbps 16-48 KHz 2 Channel
AAC Audio (MAIN, ADIF, ATDS Header, AAC-LC, AAC-HE)	AAC M4A	3-576 Kbps 8-48 KHz 5.1 Channel

Media Player Image Compatibility		
Format	File Types	Max Resolution
JPEG (JFIF file format 1.2)	JPG JPEG	1920 x 1080
BMP	BMP	15360 x 8640
PNG	PNG	1920 x 1080

21.2 Main Menu

Play

- This menu starts showing the content in a created playlist. If no playlists are available, create one starting with the Compose section on page 92.
- The content will play in the order selected during content creation, and with the features selected in the Settings menu.

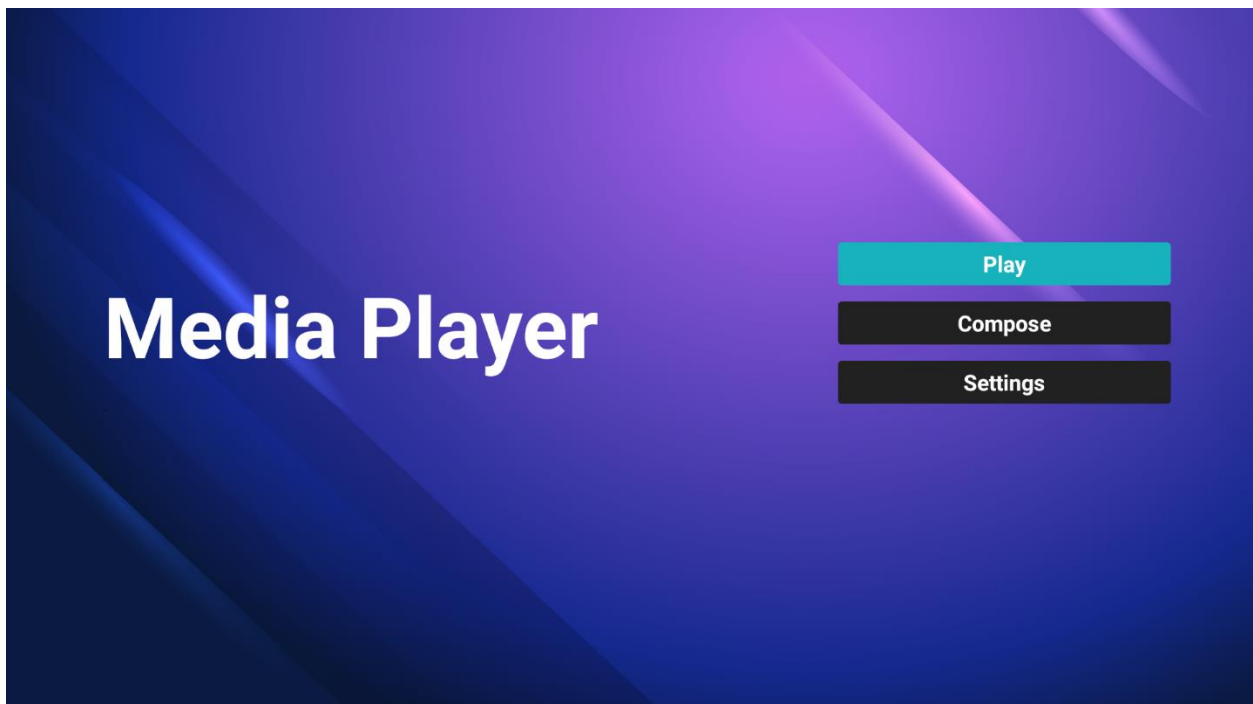

Compose

- Use this menu to create a playlist of photos and/or videos.
- Select media from
 - Internal
 - USB
 - SD card
- Photos must be in the following folder: /planar/photo
- Videos must be in the following folder: /planar/video
- Audio files must be in the following folder: /planar/music

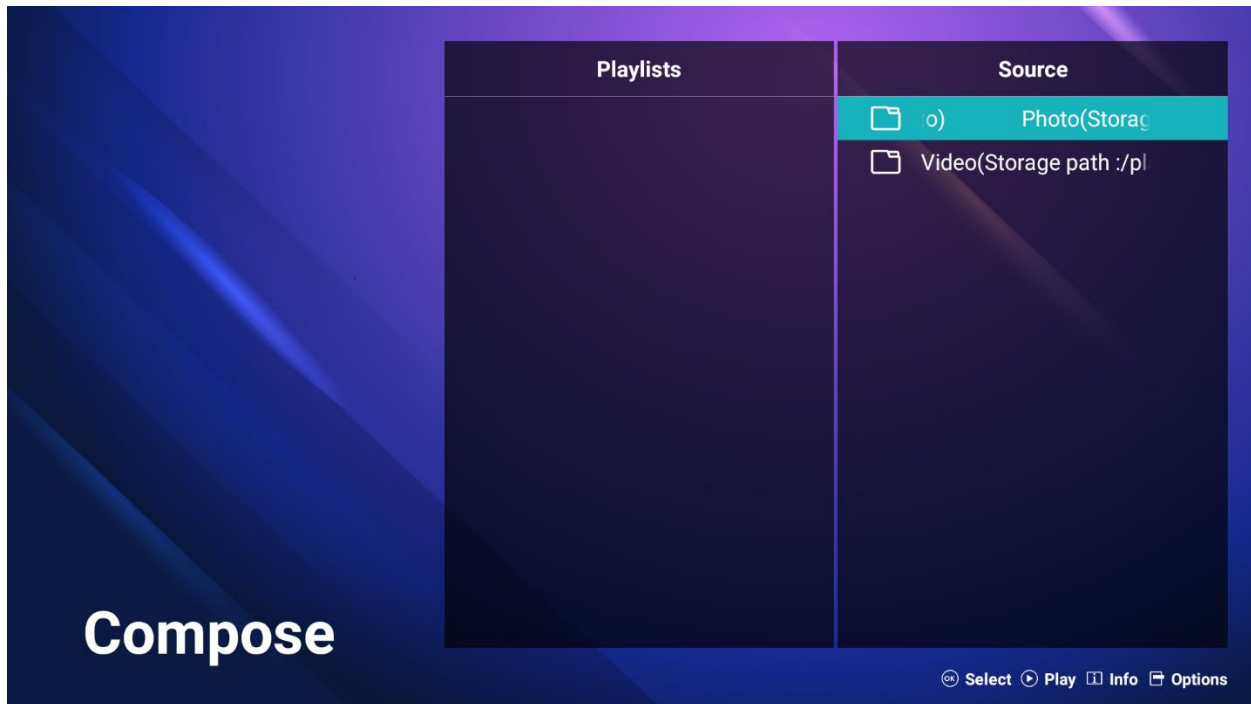

- Press the Options key on the remote to bring up the sidebar menu

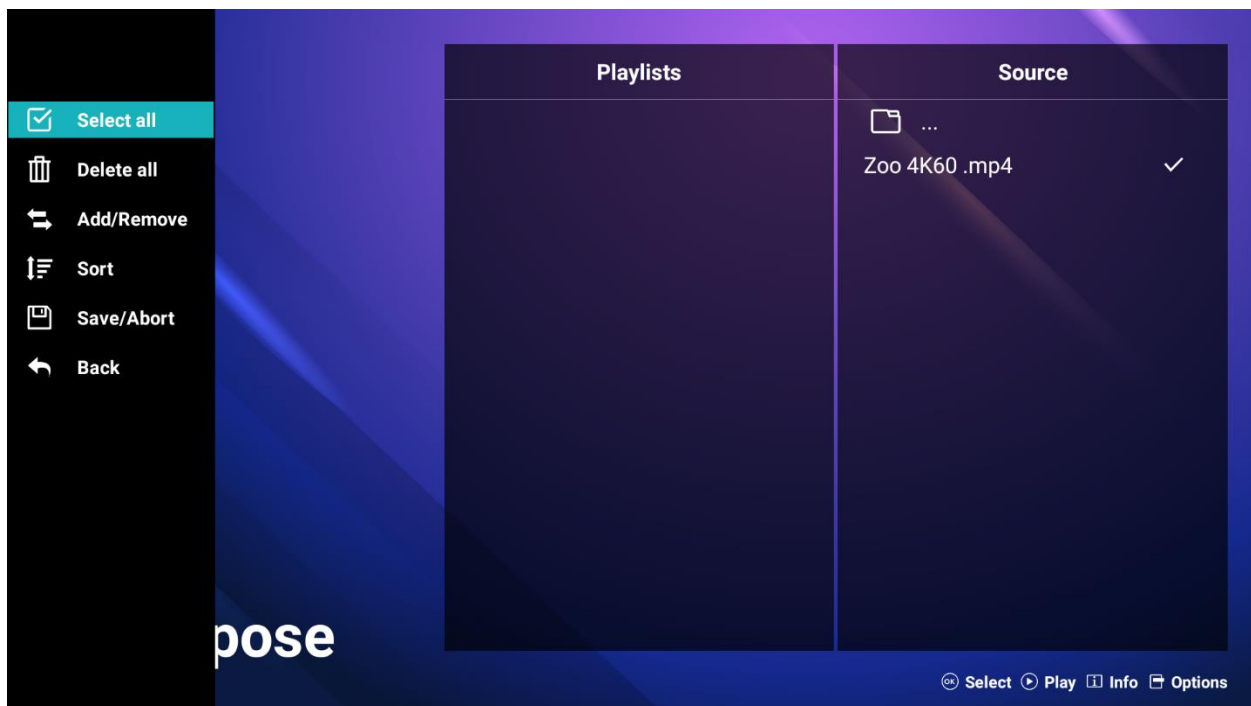

- Select All: Select all items in the current folder, and de-select all items in the current playlist
- Delete All: Remove all items from the current playlist
- Add / Remove: Add or keep checked items in the playlist.
- Remove unchecked items from the playlist if present.
- Sort: Rearrange the order of files in the playlist
- Save / Abort: Save or discard the changes to the playlist
 - **Note:** Save changes to the playlist once, modifications are complete. Any unsaved changes will be lost.
- After saving the playlist, background music can be added.
 - **Note:** This option is displayed after saving a playlist (see image below).
- Back: Close the sidebar menu

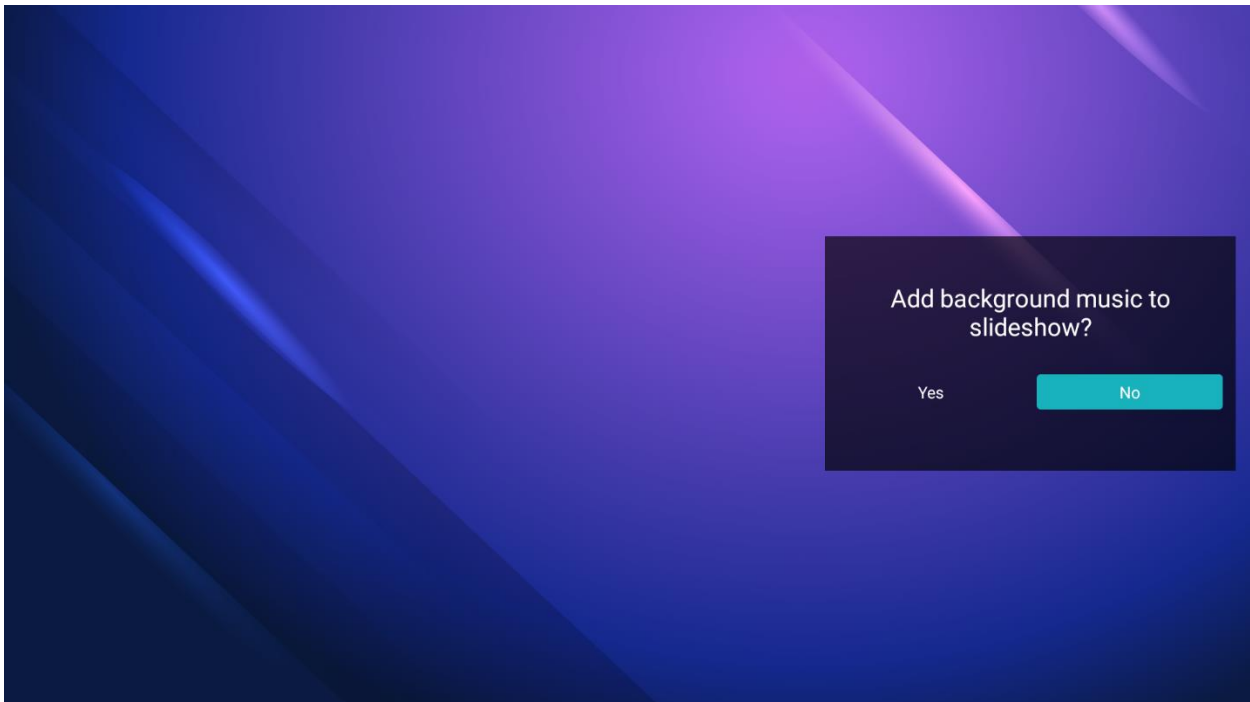

Settings

- This menu contains several options for customizing your playback experience

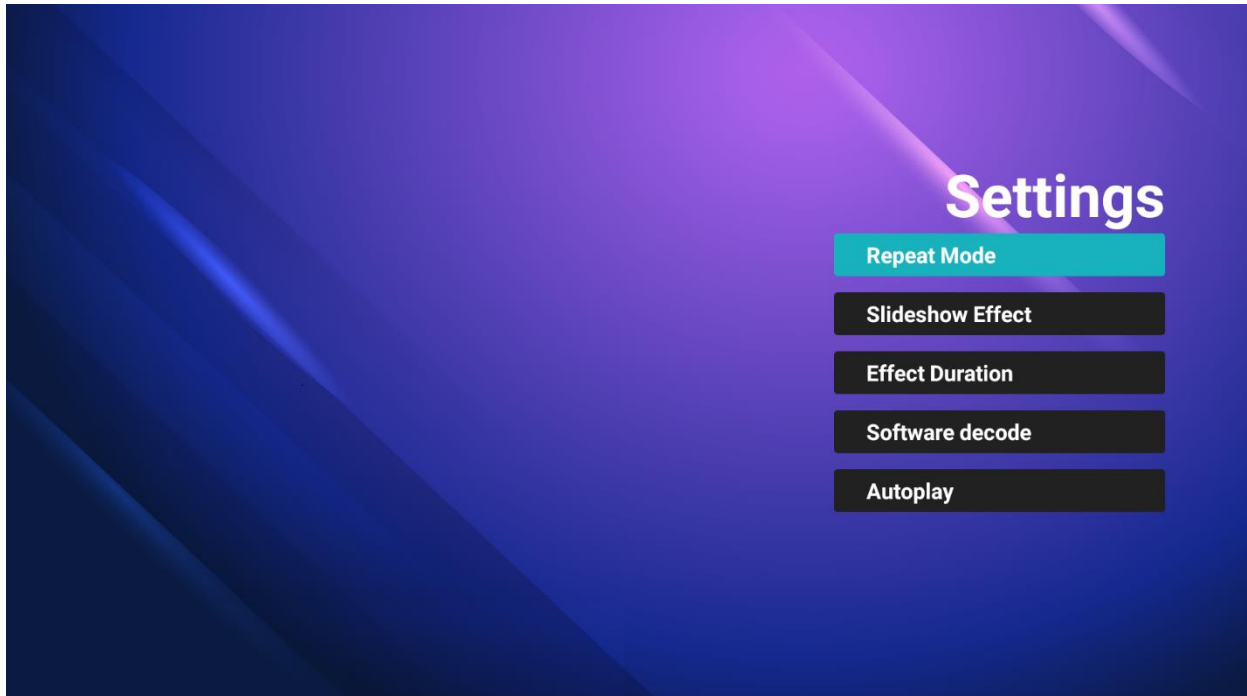

- Repeat Mode
 - Play each file only one time or repeat them
 - **Options:** Repeat Once (display each file once), Repeat All (repeat showing all files)
 - **Default:** Repeat All
- Slideshow Effect
 - Select the transition type that occurs when switching from one image to another
 - **Options:** Random, Bounce, Fade In/Out, Top to Bottom, Zoom, Left to Right, Right to Left, Fold, Corner, None
 - **Default:** None
- Effect Duration
 - Select the amount of time to show each image in the playlist
 - **Options:** 5 sec, 10 sec, 15 sec, 20 sec
 - **Default:** 5 sec
- Software Decode
 - Not supported.

- Autoplay

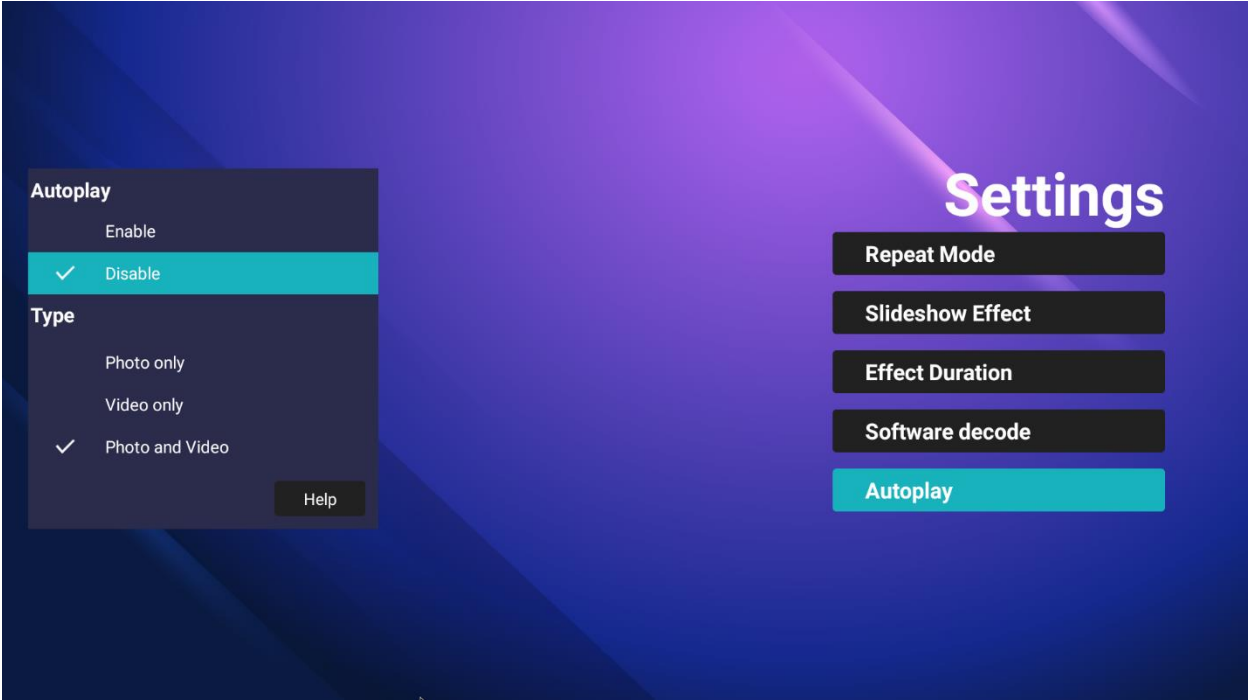

22. Browser Menu

The Planar Simplicity M Series display has an embedded browser that can be used to schedule and deploy simple, web-based content. Please see below for more information.

22.1 Compose

This menu offers seven input fields for URL configuration using manual entry and import and export list functions.

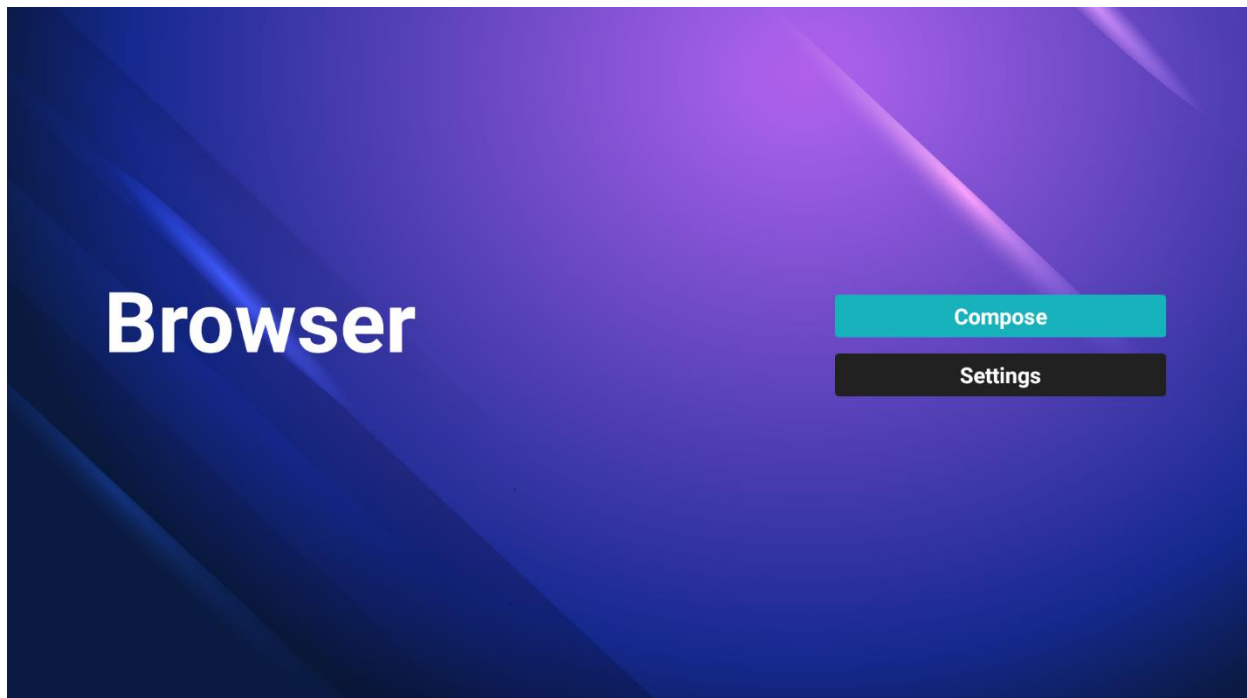

- Click Compose and choose any list item (1-7) then enter a URL. Press Ok to save data on the list. See figure below for reference.

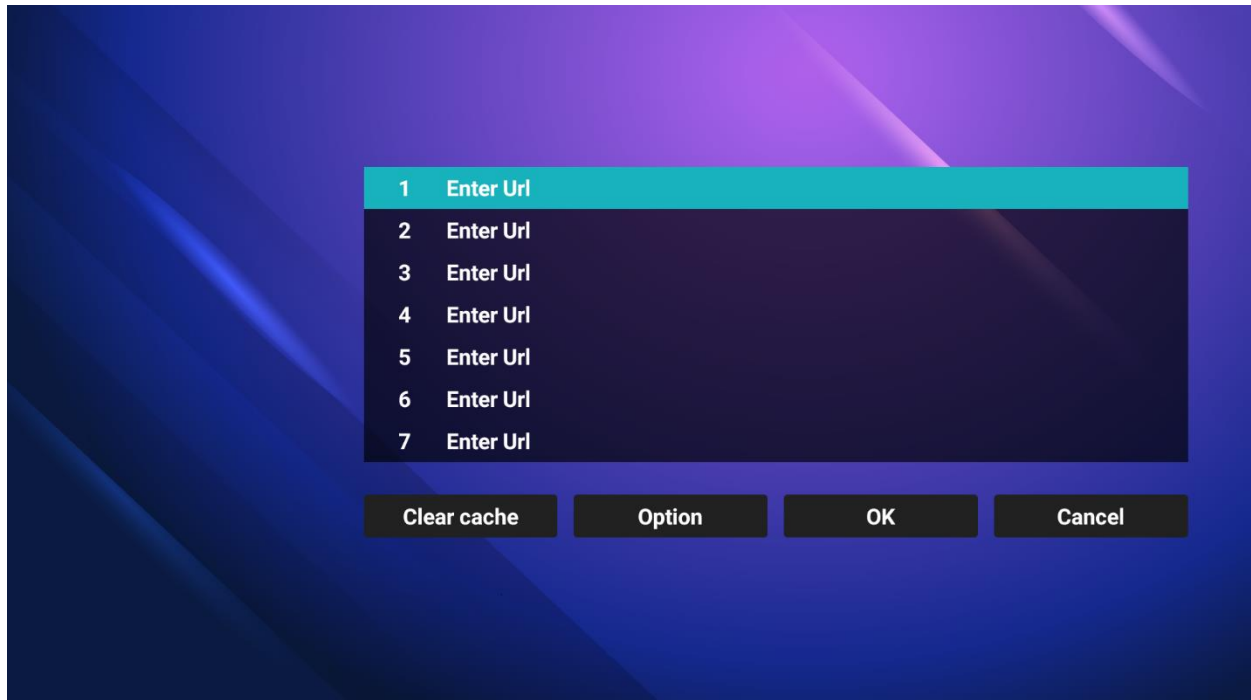

Option

- This sidebar menu accesses import and export functions for the URL list.
- To access the menu, scroll past the last URL entry and click Option.

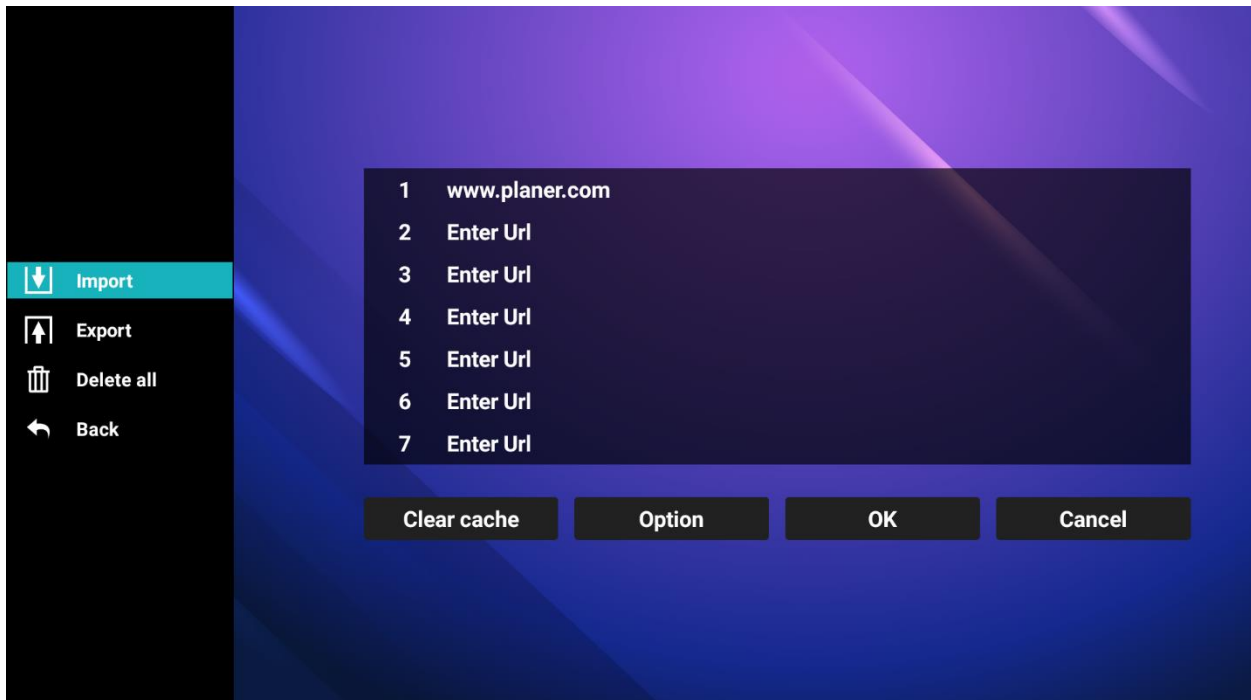

- Import
 - Import URLs from a text file from one of the following sources:
 - Internal
 - USB
 - SD card
 - Click Import and choose storage location, select file, and press Import to add URLs in to the URL list.
 - **Note:** The file containing URLs must be formatted as a text file and placed in the following folder: /planar/browser

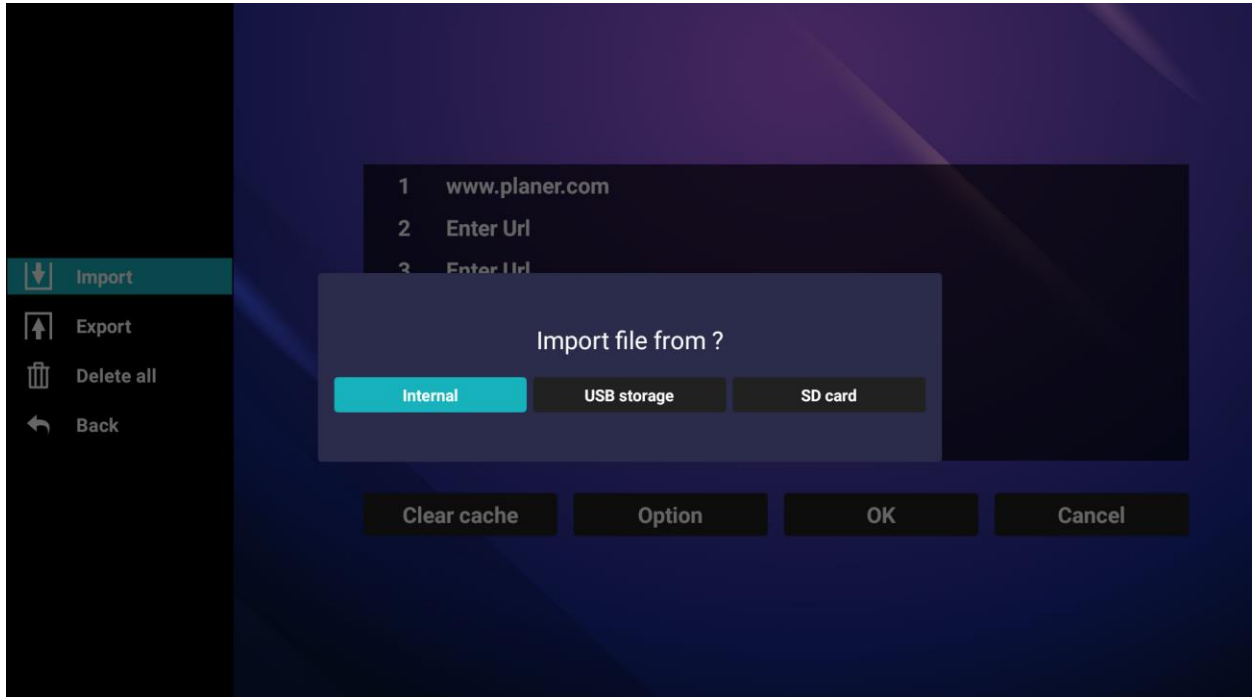

- Export
 - Export the URL list to a file on one of the following sources:
 - Internal
 - USB
 - SD card
 - Choosing internal storage opens a dialogue box showing the file path and file name. Saving the list to the internal location specified in the storage path makes the list available as future internal import option
 - Press save and Ok to navigate back to the main menu.
 - **Note:** If you do not click Ok then changes made to the list will not save.

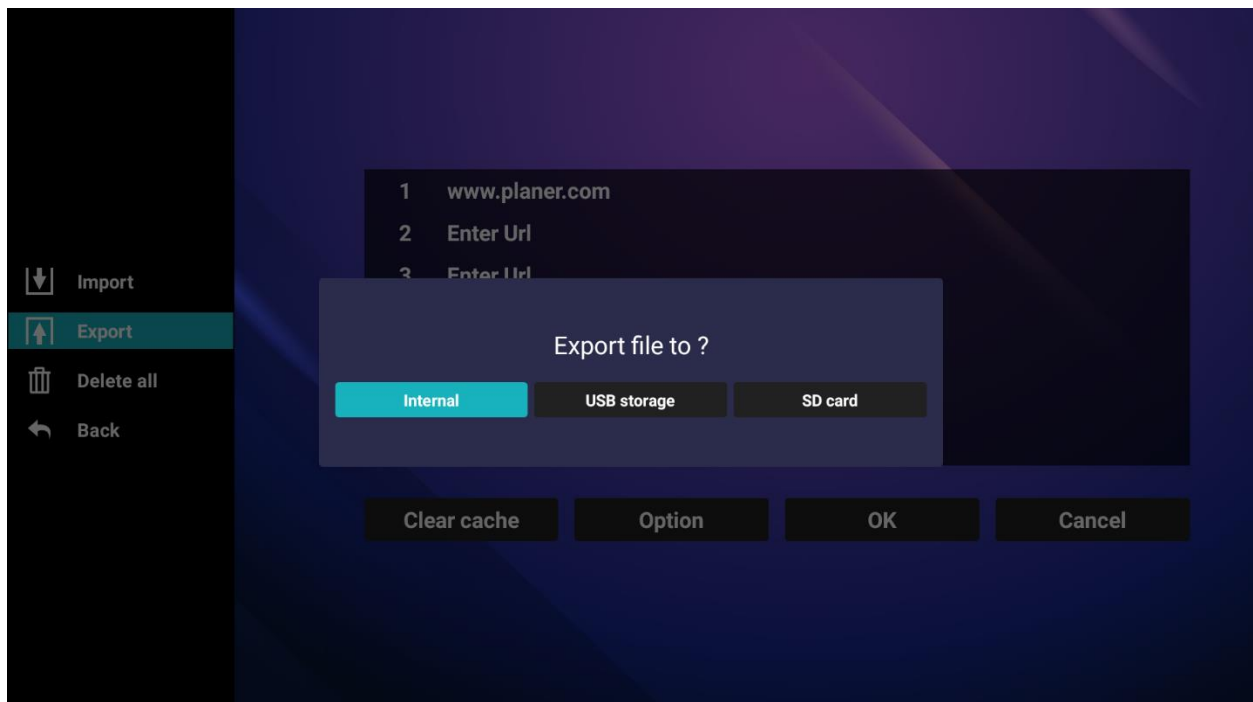

- Delete all
 - Deletes all URL records from the URL list page
- Back
 - Closes sidebar option menu
- Once URL list options are saved, you can choose to Edit or Play a URL
 - Edit: Edit existing URL dialog
 - Play: Navigates to and opens the webpage stated by the URL

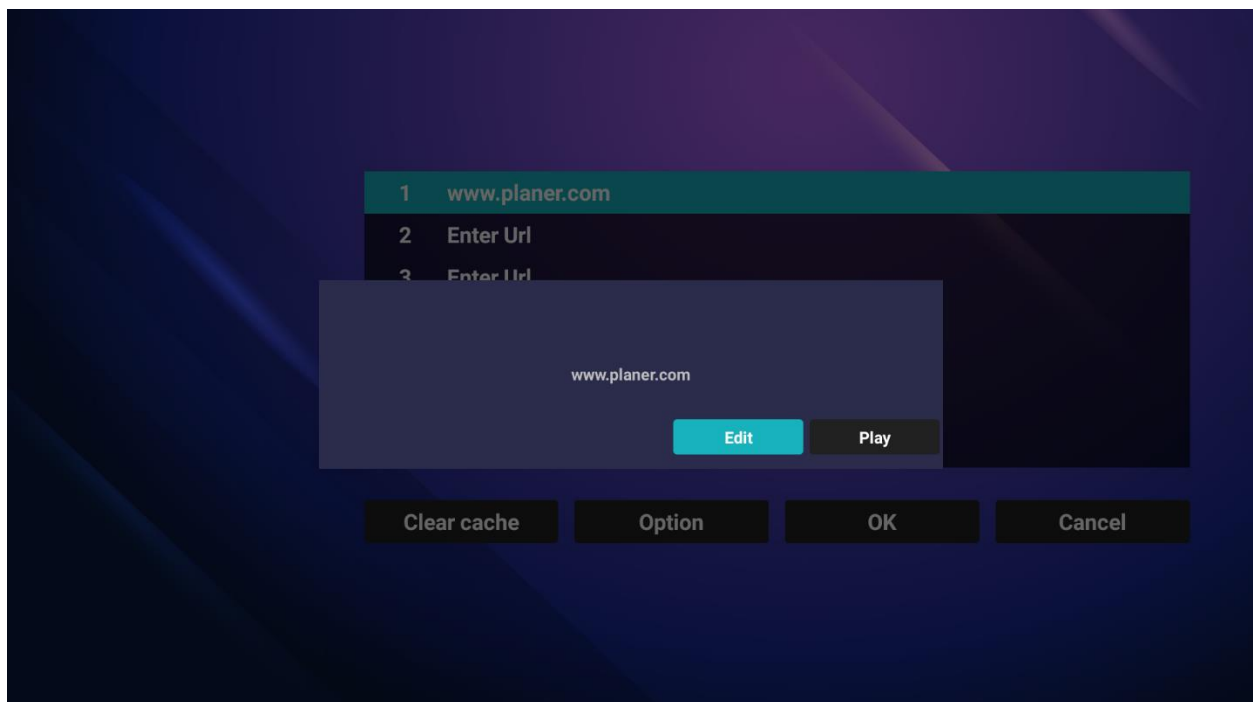

22.2 Settings

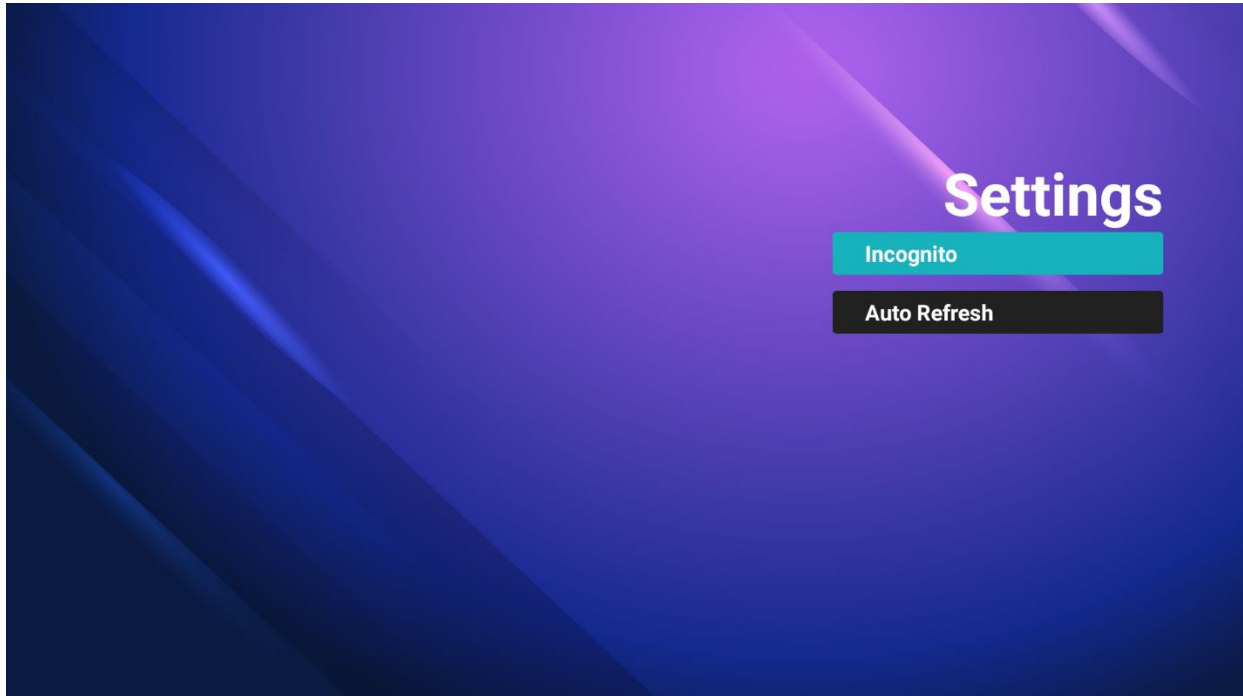

This menu contains several browser options.

- Incognito
 - Select private browsing mode.
 - **Settings:** Disable, Enable
 - **Default:** Disable

- Auto Refresh
 - Setup automatic reloading of the web page on a periodic basis.

22.3 Boot on Source Functionality

Browser is one of the OSD Menu Boot On Source options (see page 56).

- To configure this setting go to the OSD Menu, select Configuration 1, and set input to Browser.
- Choose a numbered URL option from the URL list and press Save.
 - **Note:** The Default Browser in the Boot on Source Menu is 0. If you do not assign a URL list number, the display will restart showing the Browser Settings Menu. The picture below is from OSD menu for reference.

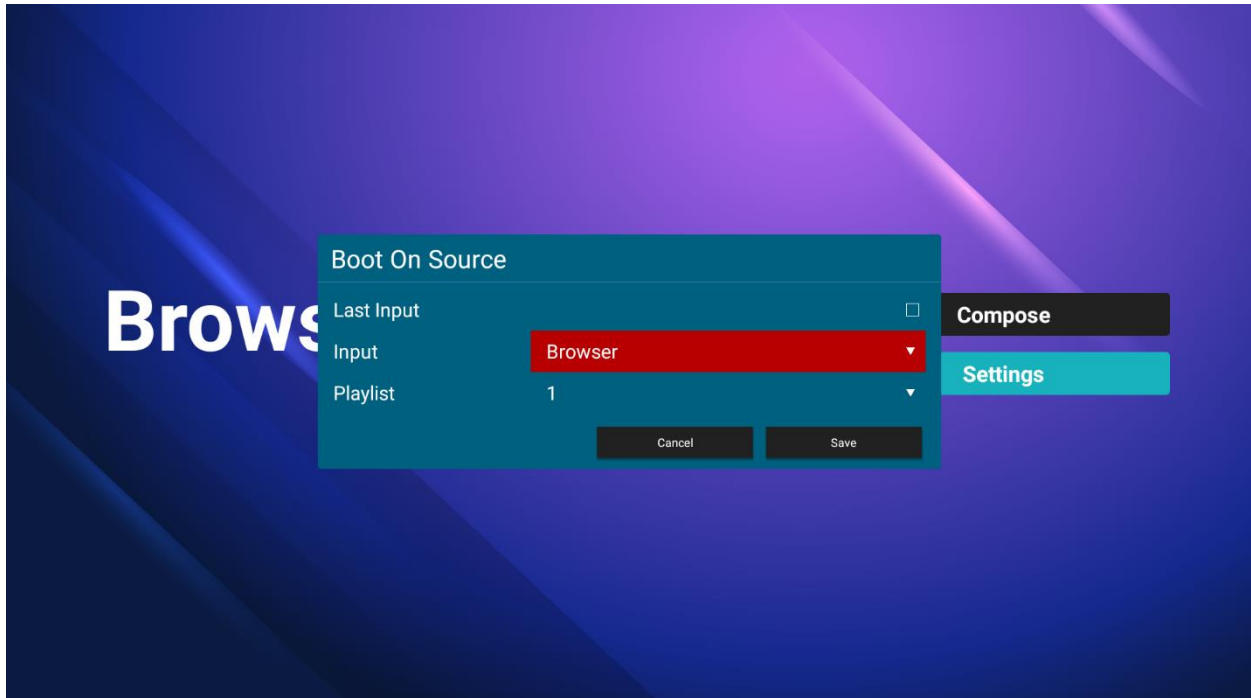

23. Content Management System

CMS Source opens HyperSign app. See [Hypersign.com](https://hypersign.com) for more information.

External Control

In addition to using the Planar Simplicity M Series remote control and display, there are other methods of controlling the Planar Simplicity M Series display externally:

- Using a serial link to send commands and to receive responses to those commands. The same set of commands can be sent over RS-232, TCP or UDP. See the *Planar Simplicity M Series RS232 User Manual* for more information.
- Using discrete infrared (IR) codes to program a third-party remote control.

Signal Compatibility

Compatible Video Sources								
Signal Type	Resolution	Frame Rate (Hz)	Line Rate (kHz)	Pixel Rate (MHz)	HDMI 1-2	USB-C	VGA	References
PC	640x350	70.090	31.469	25.175	x	x	x	
	640x480	59.940	31.469	25.175	x	x	x	VESA DMT, CEA-861-F Format 1
	640x480	72.809	37.861	31.500	x	x	x	VESA DMT
	640x480	75.000	37.500	31.500	x	x	x	VESA DMT
	720x400	70.087	31.469	28.322	x	x	x	
	800x600	56.250	35.156	36.000	x	x	x	
	800x600	60.317	37.879	40.000	x	x	x	VESA DMT
	800x600	72.188	48.077	50.000	x	x	x	VESA DMT
	800x600	75.000	46.875	49.500	x	x	x	VESA DMT
	832x624	74.551	49.726	57.284	x	x	x	
	1024x768	60.004	48.363	65.000	x	x	x	VESA DMT
	1024x768	70.069	56.476	75.000	x	x	x	VESA DMT
	1024x768	75.029	60.023	78.750	x	x	x	VESA DMT
	1280x720	59.855	44.772	74.500	x	x	x	VESA CVT
	1280x768	59.870	47.776	79.500	x	x	x	VESA CVT
	1280x768	74.893	60.289	102.250	x	x	x	
	1280x800	59.810	49.700	83.500	x	x	x	
	1280x1024	60.020	63.981	108.000	x	x	x	VESA DMT
	1280x1024	75.025	79.976	135.000	x	x	x	VESA DMT
	1440x900	59.887	55.935	106.500	x	x	x	
1680x1050	59.954	65.290	146.250	x	x	x	VESA CVT	
1920x1080	59.934	66.587	138.500	x	x	x	VESA CVT-R	
SDTV	480i	60			x	x		SMPTE 125M, CEA-861-F Formats 6 & 7
	576i	50			x	x		ITU-R BT.601, CEA-861-F Formats 21 & 22
EDTV	480p	60	31.469	27.000	x	x	x	ITU-R BT.1358, CEA-861-F Format 17 & 18
	576p	50	31.250	27.000	x	x		SMPTE 125M, CEA-861-F Format 6 & 7
HDTV	1080i	50	28.125	74.500	x	x		SMPTE 274M, CEA-861-F Format 20
	1080i	60	33.750	74.250	x	x		SMPTE 274M, CEA-861-F Format 5
	720p	50	37.500	74.250	x	x	x	SMPTE 296M, CEA-861-F Format 19
	720p	60	45.000	74.250	x	x	x	SMPTE 296M, CEA-861-F Format 4
	1080p	50	56.250	148.500	x	x	x	SMPTE 274M, CEA-861-F Format 31
	1080p	60	67.500	148.500	x	x	x	SMPTE 274M, CEA-861-F Format 16
UHDTV	3840x2160	24	54.000	297.000	x	x		CEA-861-F Format 93, HDMI 1.4b VIC 1
	3840x2160	25	56.250	297.000	x	x		CEA-861-F Format 94, HDMI 1.4b VIC 2
	3840x2160	30	67.500	297.000	x	x		CEA-861-F Format 95, HDMI 1.4b VIC 3
	3840x2160	50	56.250	297.000	x	x		CEA-861-F Format 96, 4:2:0 sub-sampling
	3840x2160	50	112.500	594.000	x	x		CEA-861-F Format 96
	3840x2160	60	67.500	297.000	x	x		CEA-861-F Format 97, 4:2:0 sub-sampling
	3840x2160	60	135.000	594.000	x	x		CEA-861-F Format 97

Color Subsampling Support

Video Timing	Input	RGB 4:4:4 Supported	YUV 4:4:4 Supported	YUV 4:2:2 Supported	YUV 4:2:0 Supported
4K @ 50/60Hz	HDMI 1-2	x	x	x	x
4K @ 50/60Hz	USB-C	x	x	x	x
All Other Supported Timings	HDMI 1-2	x	x	x	
All Other Supported Timings	USB-C	x	x	x	
All Other Supported Timings	VGA	x	x		

Power Consumption

The power consumption values stated in the Specifications table are calculated under the typical conditions of viewing a single source with default settings. The “Power Consumption: Backlight Max (Typ.)” value is instead calculated by increasing the default value of 90 to 100, and multiplying the wattage by approximately 1.1. The power consumption would increase if any other factor was introduced and should be taken into account when estimating power consumption.

Specifications

Item	SLM432 SLM432-T	SLM502 SLM502-T	SLM552 SLM552-T	SLM652 SLM652-T	SLM752 SLM752-T	SLM862 SLM862-T
LCD Panel						
Resolution	3840x2160					
Aspect Ratio	16:9					
Screen Size	43"	50"	55"	65"	75"	86"
Orientation	Landscape					
Brightness (Typ.)	Non-T versions: 500 cd/m ² -T versions: 400 cd/m ²					
Contrast Ratio (Typ.)	1200:1	5000:1	1200:1	1200:1	5000:1	1200:1
Viewing Angle (Typ.)	178 degrees					
Response Time (Typ.)	8ms	9.5ms	8ms	8ms	8ms	8ms
Color Gamut	72% NTSC					
Display Color	1.07 billion (10-bit depth)					
Haze (Typ.)	25%	25%	25%	25%	25%	22%
Connectivity						
Standard Inputs	HDMI x 2, USB-C x 1, VGA, USB 3.0 x 1, USB 2.0 x 1, Media Player					
HDCP 2.2	Yes (HDMI)					
Audio Output	Line out, S/PDIF out					
Control and Monitoring	LAN RJ45, RS232, IR In/Out, HDMI-CEC, Keypad					
Mechanical						
Display Dimensions w/ Handles	N/A	N/A	N/A	N/A	SLM752: 66.3" x 37.9" x 3.8" (1683.5mm x 961.7mm x 95.3mm) SLM752-T: 67.2" x 38.8" x 3.9" (1706.2mm x 984.5mm x 98.2mm)	SLM862: 75.9" x 43.3" x 3.8" (1929.1mm x 1100.0mm x 95.3mm) SLM862-T: 76.8" x 44.2" x 3.9" (1951.8mm x 1122.5mm x 98.2mm)

Item	SLM432 SLM432-T	SLM502 SLM502-T	SLM552 SLM552-T	SLM652 SLM652-T	SLM752 SLM752-T	SLM862 SLM862-T
Display Dimensions w/o Handles	SLM432: 37.8" x 21.8" x 2.4" (961.0mm x 553.2mm x 59.8mm) SLM432-T: 38.7" x 22.5" x 2.5" (984.0mm x 572.2mm x 62.8mm)	SLM502: 44.2" x 25.4" x 2.4" (1121.6mm x 646.0mm x 59.8mm) SLM502-T: 45.2" x 26.3" x 2.5" (1147.4mm x 668.0mm x 62.8mm)	SLM552: 48.6" x 27.8" x 2.4" (1235.4mm x 706.2mm x 59.8mm) SLM552-T: 49.4" x 28.6" x 2.5" (1254.4mm x 725.2mm x 62.8mm)	SLM652: 57.3" x 32.6" x 2.4" (1454.3mm x 829.3mm x 59.8mm) SLM652-T: 58.0" x 33.2" x 2.5" (1473.3mm x 843.0mm x 62.8mm)	SLM752: 66.3" x 37.9" x 2.7" (1683.5mm x 961.7mm x 69.5mm) SLM752-T: 67.2" x 38.8" x 2.9" (1706.2mm x 984.5mm x 72.4mm)	SLM862: 75.9" x 43.3" x 2.7" (1929.1mm x 1100.0mm x 69.5mm) SLM862-T: 76.8" x 44.2" x 2.9" (1951.8mm x 1122.5mm x 72.4mm)
Bezel Width	SLM432: 0.4" (9.9mm) SLM432-T: 0.8" (19.5mm)	SLM502: 0.4" (10.9mm) SLM502-T: .8" (19.5mm)	SLM552: 0.4" (10.9mm) SLM552-T: .8" (19.5mm)	SLM652: 0.4" (10.9mm) SLM652-T: .8" (19.5mm)	SLM752: 0.6" (14.9mm) SLM752-T: 1.1" (27.3mm)	SLM862: 0.6" (15.5mm) SLM862-T: 1.1" (27.9mm)
Display Weight	SLM432: 20.3 lbs (9.2 kg) SLM432-T: 28.4 lbs (12.9 kg)	SLM502: 29.1 lbs (13.2 kg) SLM502-T: 39.0 lbs (17.7 kg)	SLM552: 35.1 lbs (15.9 kg) SLM552-T: 46.3 lbs (21.0 kg)	SLM652: 47.6 lbs (21.6 kg) SLM652-T: 63.9 lbs (29.0 kg)	SLM752: 79.6 lbs (36.1 kg) SLM752-T: 105.2 lbs (47.7 kg)	SLM862: 103.9 lbs (47.1 kg) SLM862-T: 134.3 lbs (60.9 kg)
Mounting	VESA 100x200	VESA 200x200	VESA 300x300	VESA 400x400	VESA 600x400	VESA 600x400
Fanless	Yes					
Speakers	10W x 2 built-in					
Usage						
Recommended Usage	16x7					
Backlight	D-LED					
Backlight Life	30,000 hours min					
Power Source						
USB Power Delivery	USB-C port only, offering up to 65W charging with the following outputs: 5V/3A; 9V/3A; 15V/3A; 20V/3.25A					
Power Consumption (Typ.)	95W	100W	116W	130W	150W	260W
Power Consumption Backlight Max (Typ.)*	230W	230W	255W	275W	295W	450W
BTU/hr (Typ.)	95W x 3.42 BTU = 325 BTU/hr	100W x 3.42 BTU = 342 BTU/hr	116W x 3.42 BTU = 397 BTU/hr	130W x 3.42 BTU = 445 BTU/hr	150W x 3.42 BTU = 513 BTU/hr	260W x 3.42 BTU = 889 BTU/hr
Standby Power Consumption	< 0.5W					

Item	SLM432 SLM432-T	SLM502 SLM502-T	SLM552 SLM552-T	SLM652 SLM652-T	SLM752 SLM752-T	SLM862 SLM862-T
Input Voltage / Frequency	AC 100-240V 50-60 Hz					
AC Inlet Type	C14					
Environment						
Storage Temperature	Min -4°F ~ Max 140°F (-20°C ~ 60°C)					
Operating Temperature	Min 32°F ~ Max 104°F (0-40°C) at up to 3000 m					
Humidity	20-85% RH					
Approvals	FCC Class A, NRTL, CE					
ENERGY STAR CERTIFIED	Yes					
Touch (-T models only)						
Surface Treatment	Anti-glare (AG)					
Protective Glass	2mm thermally tempered glass. 7H hardness					
Touch Technology	Projected Capacitive 20-point, 3mm minimum tip width (for all models except SLM432-T: 8mm minimum					
Touch Interface	USB-B, USB-C					
Supporting OS	Windows 10, 11, 12, Linux, Mac OSX					

* Refer to Power Consumption section (page 106) for details on how this is calculated.

Dimensions

SLM432

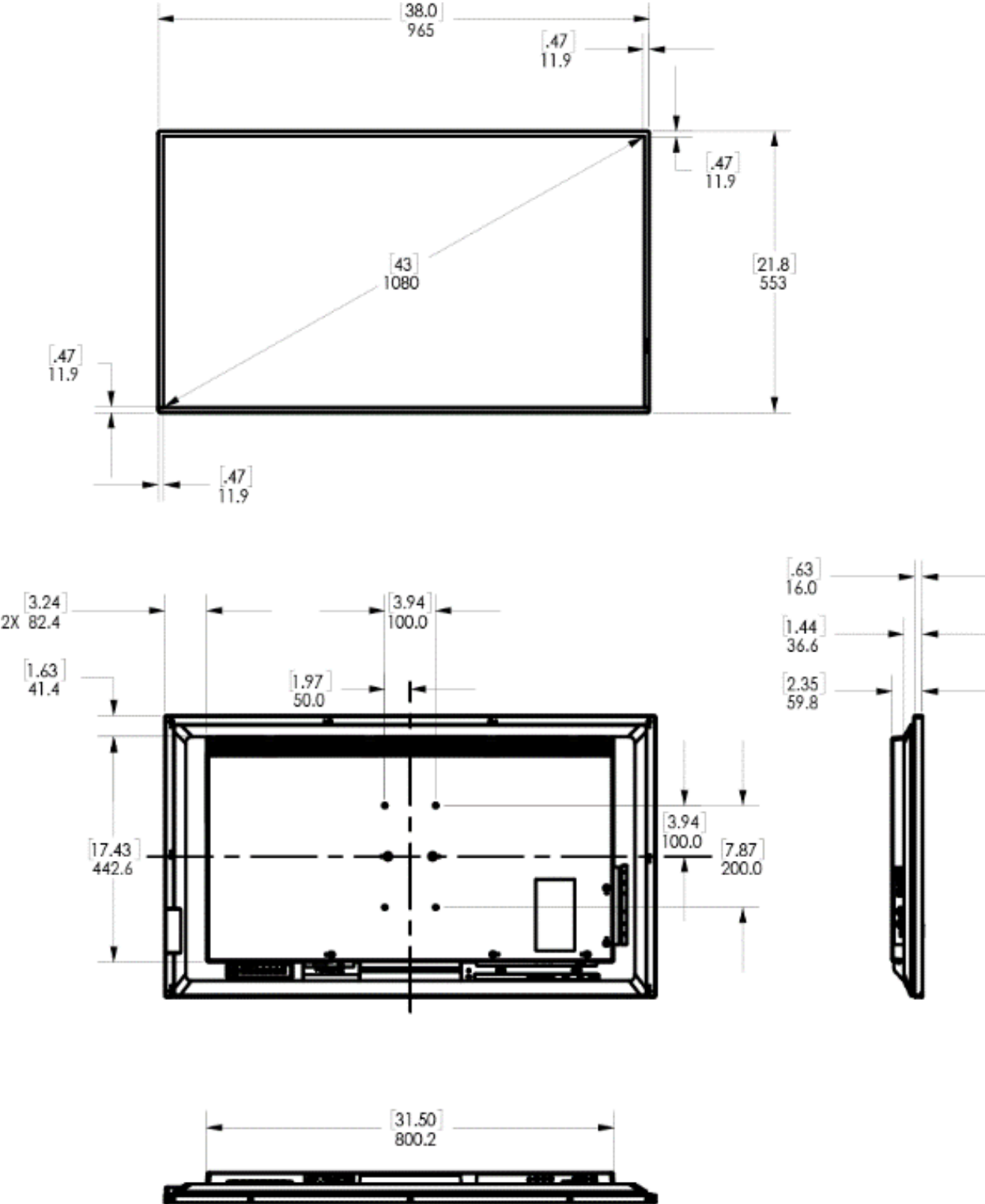

SLM432-T

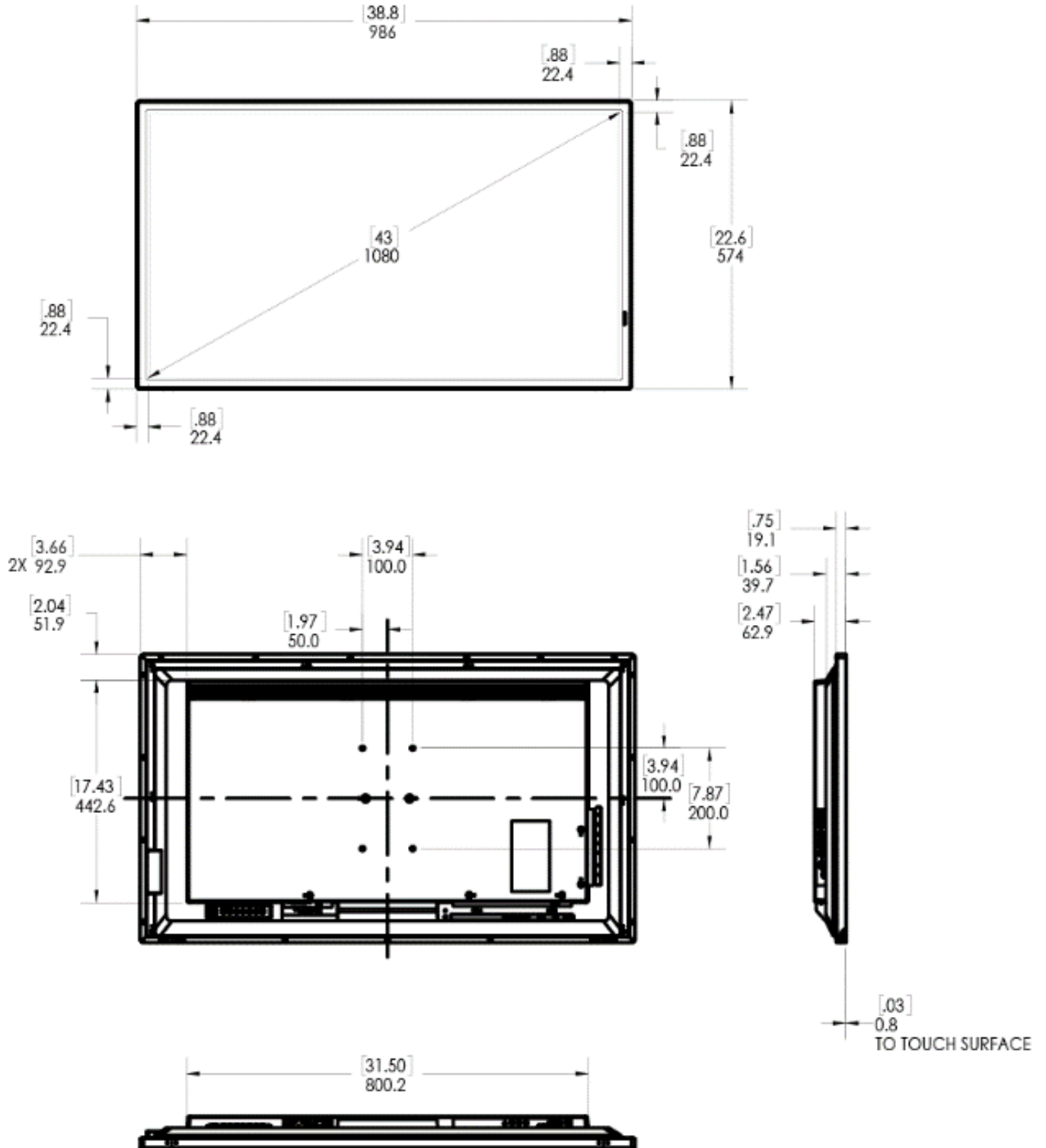

SLM502

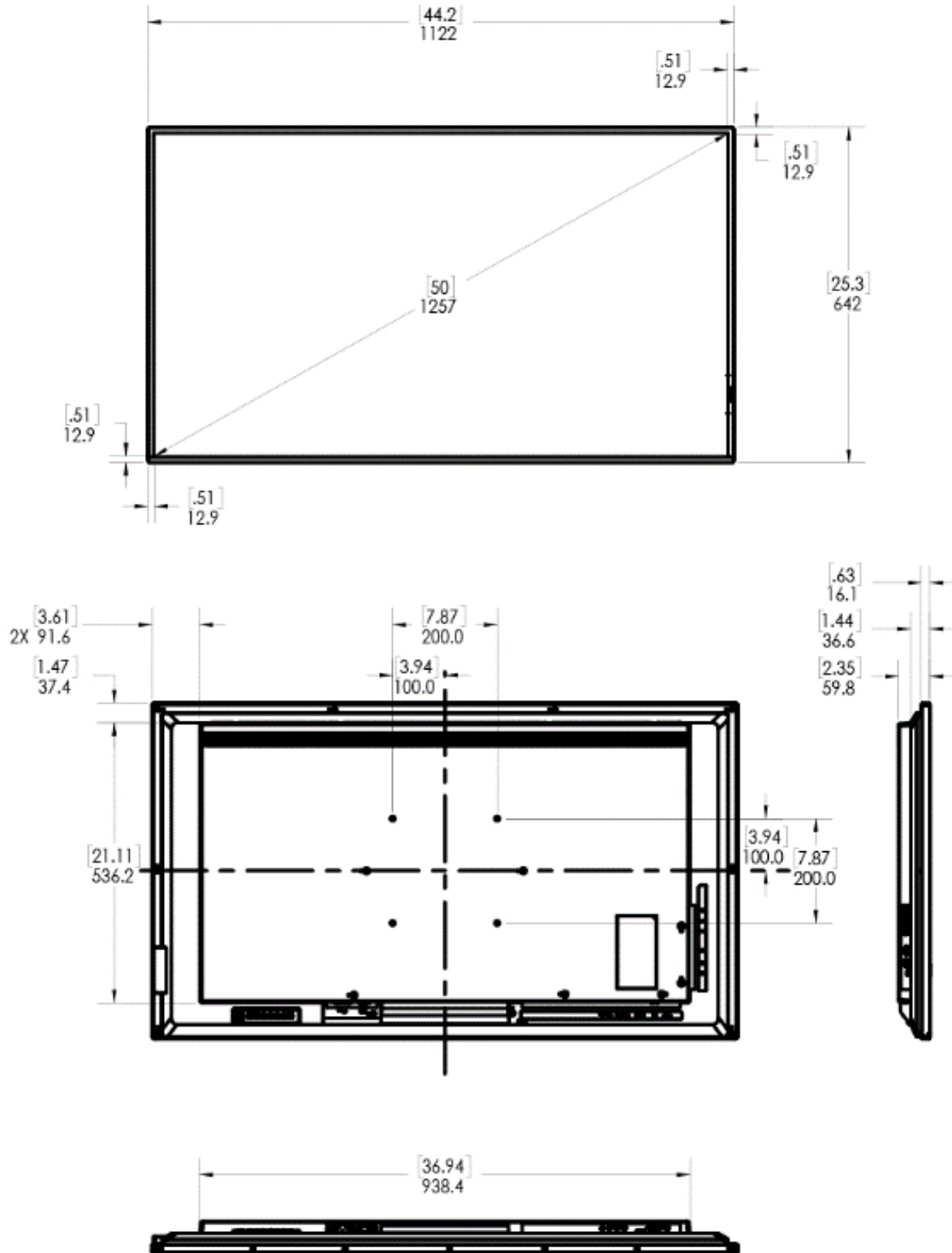

SLM502-T

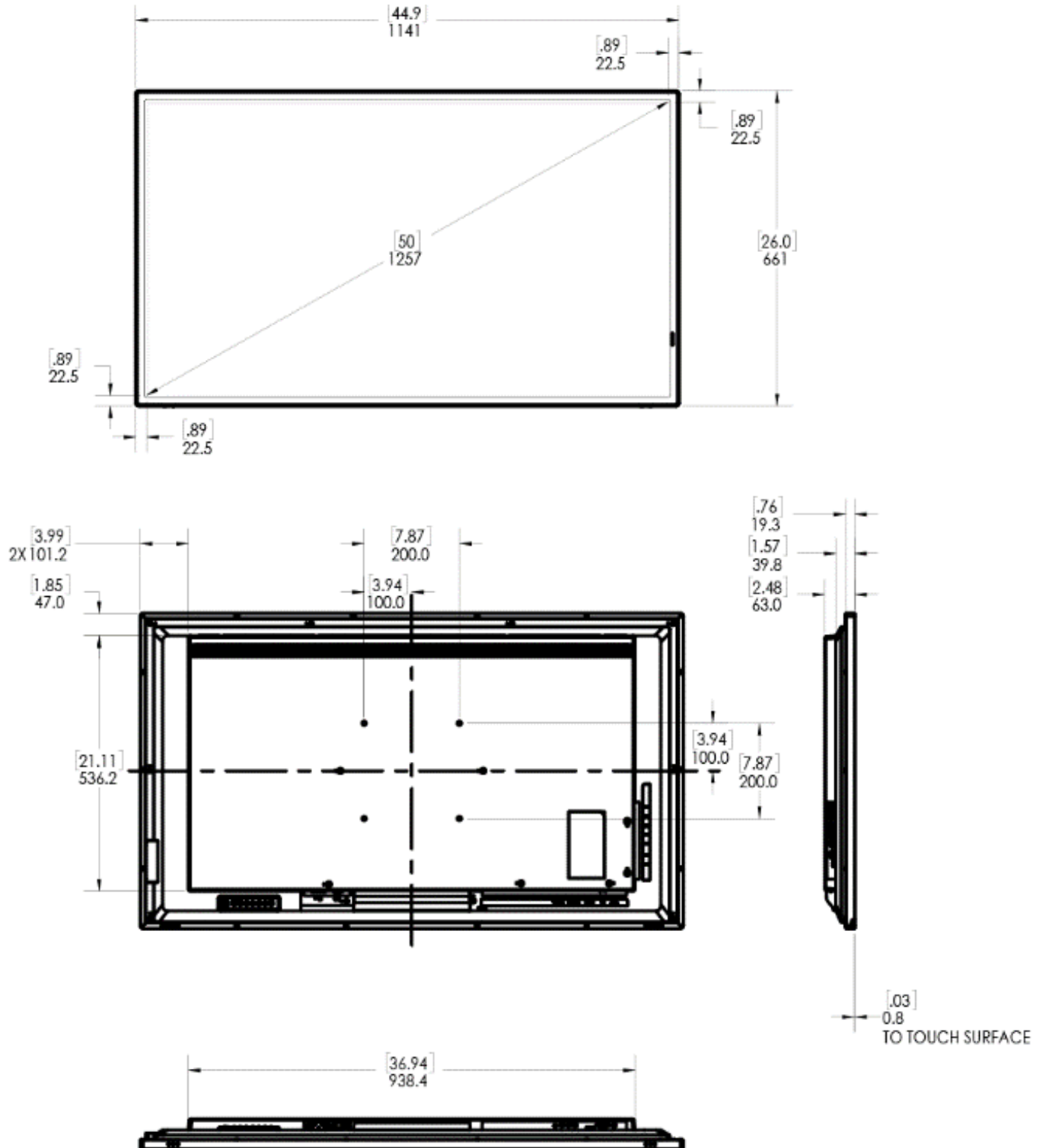

SLM552

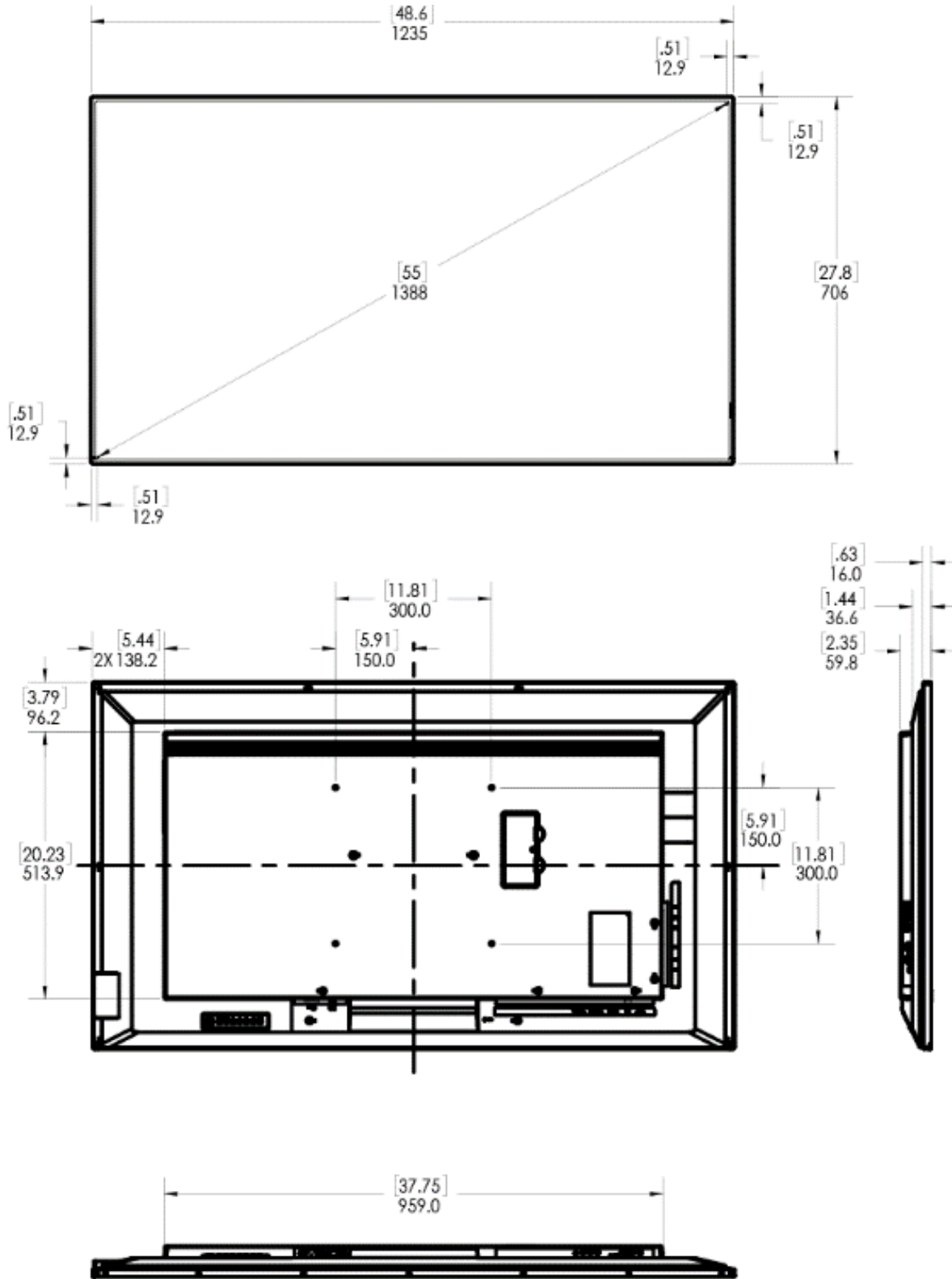

SLM552-T

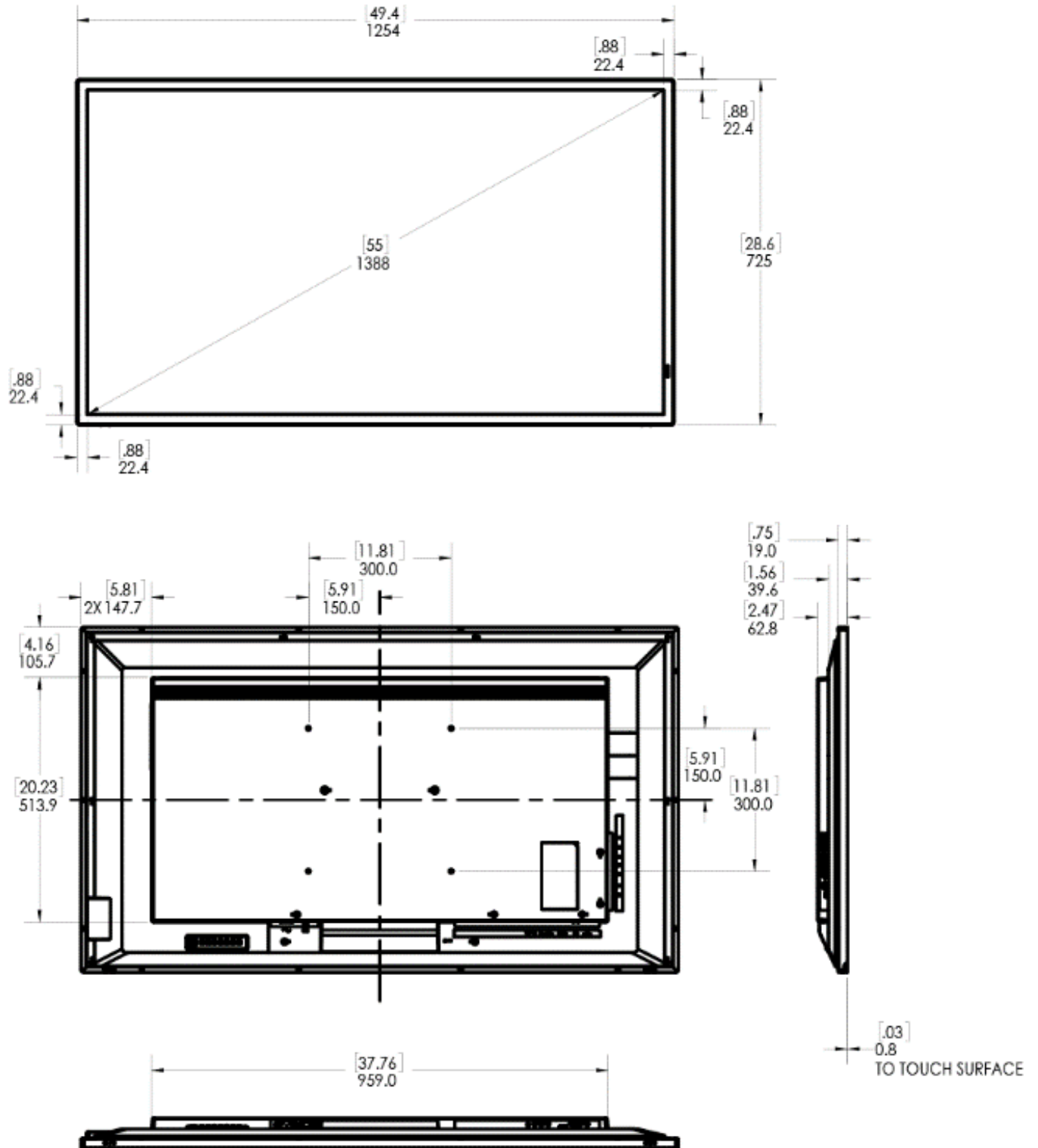

SLM652

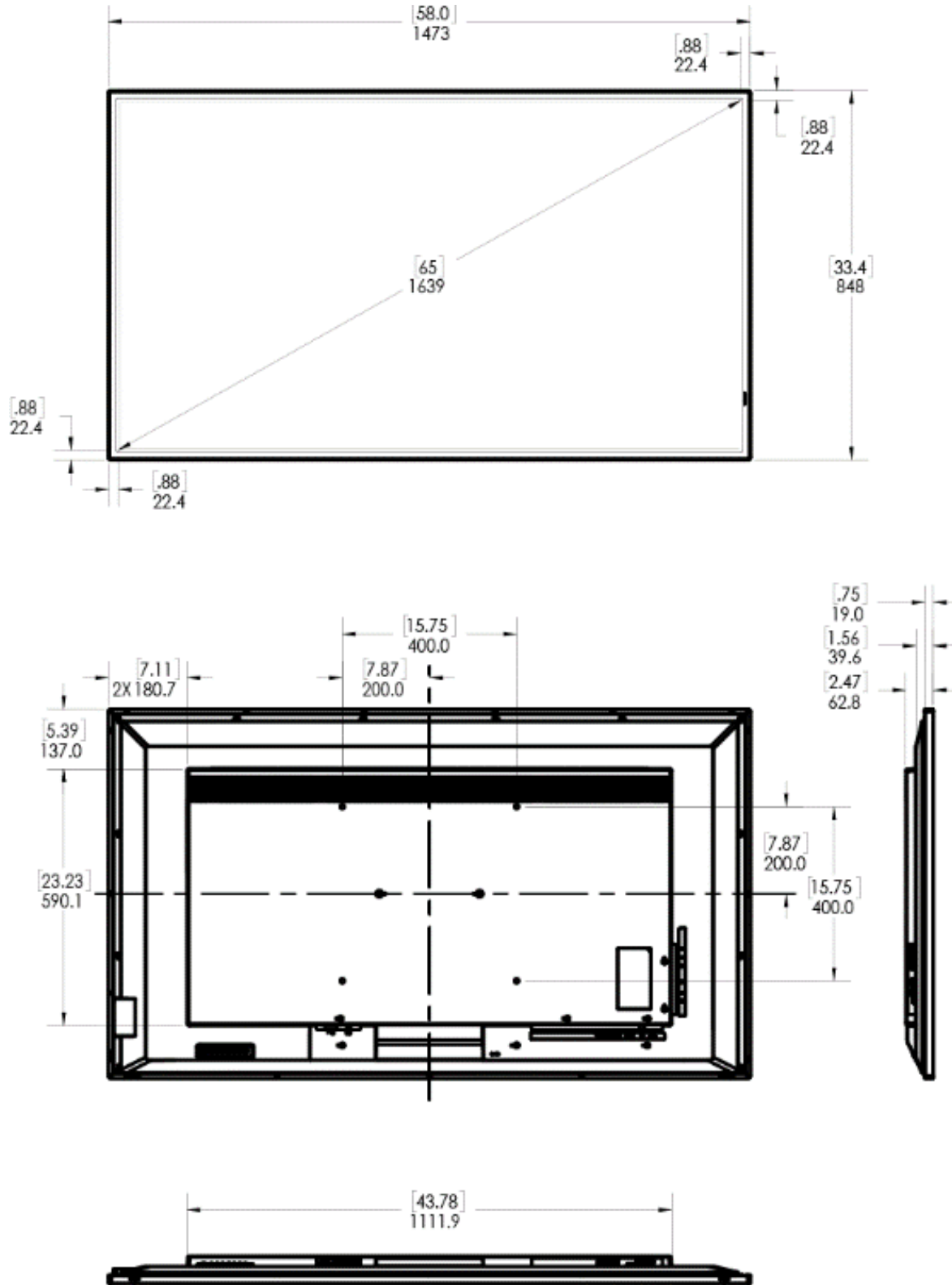

SLM652-T

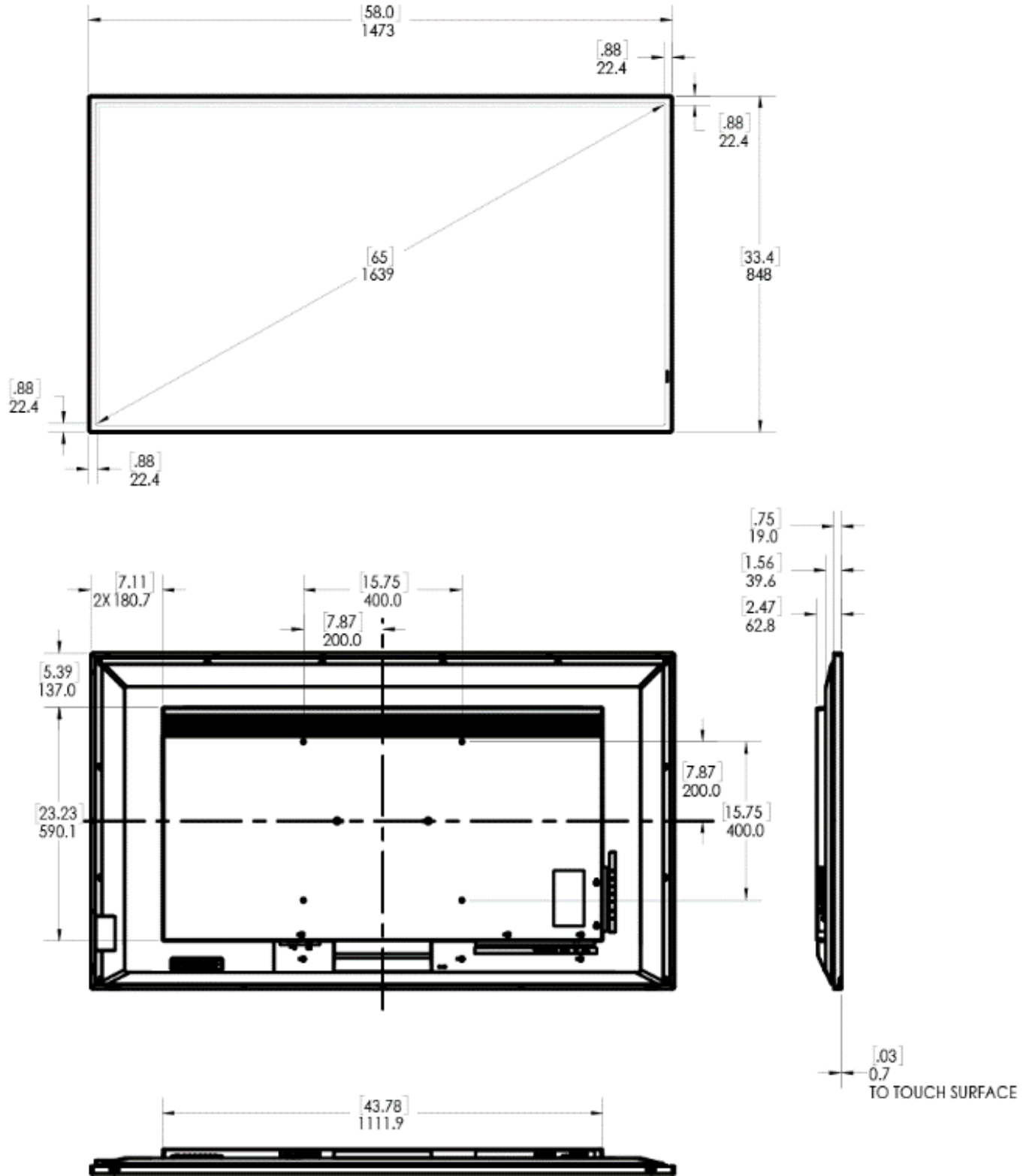

SLM752

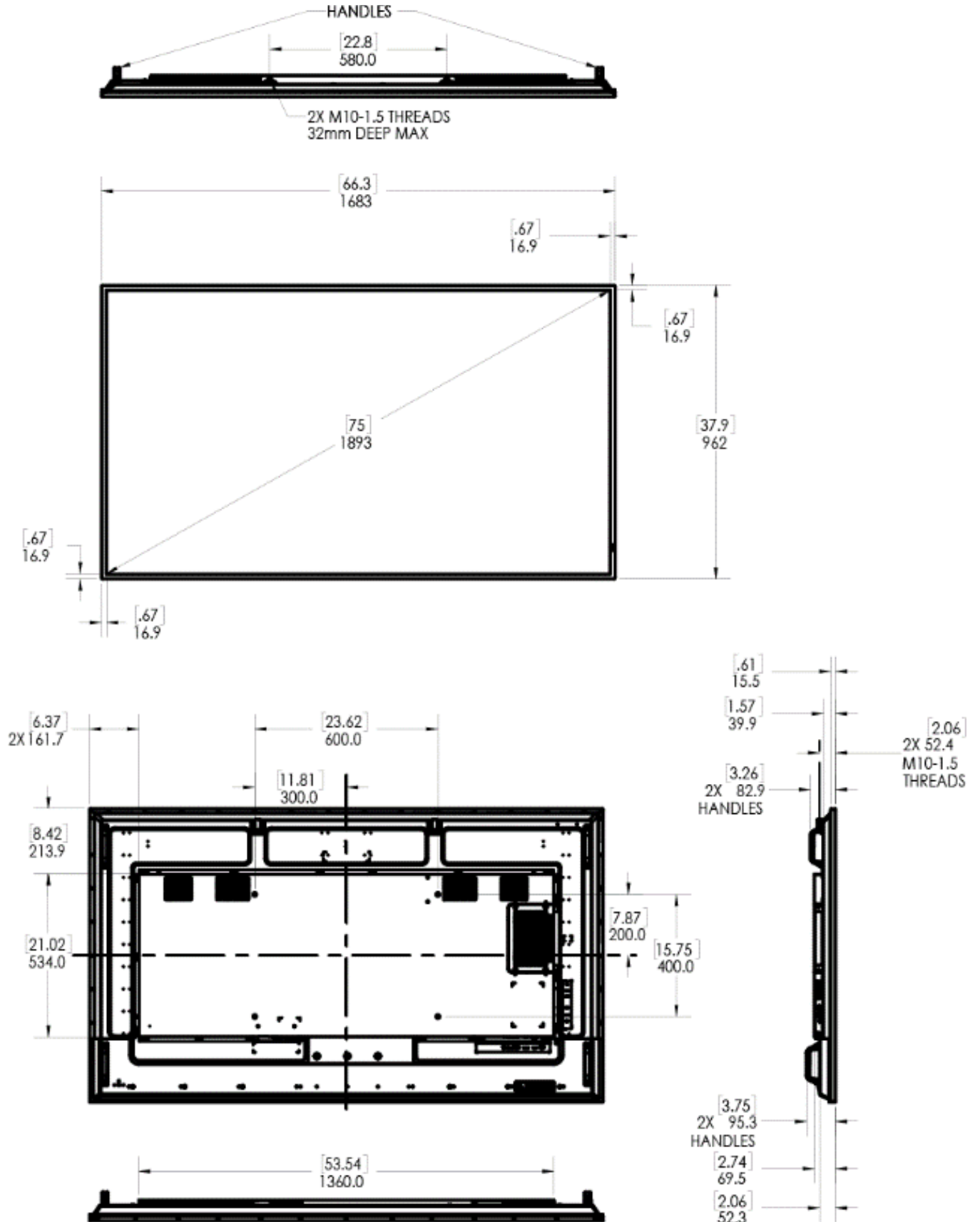

SLM752-T

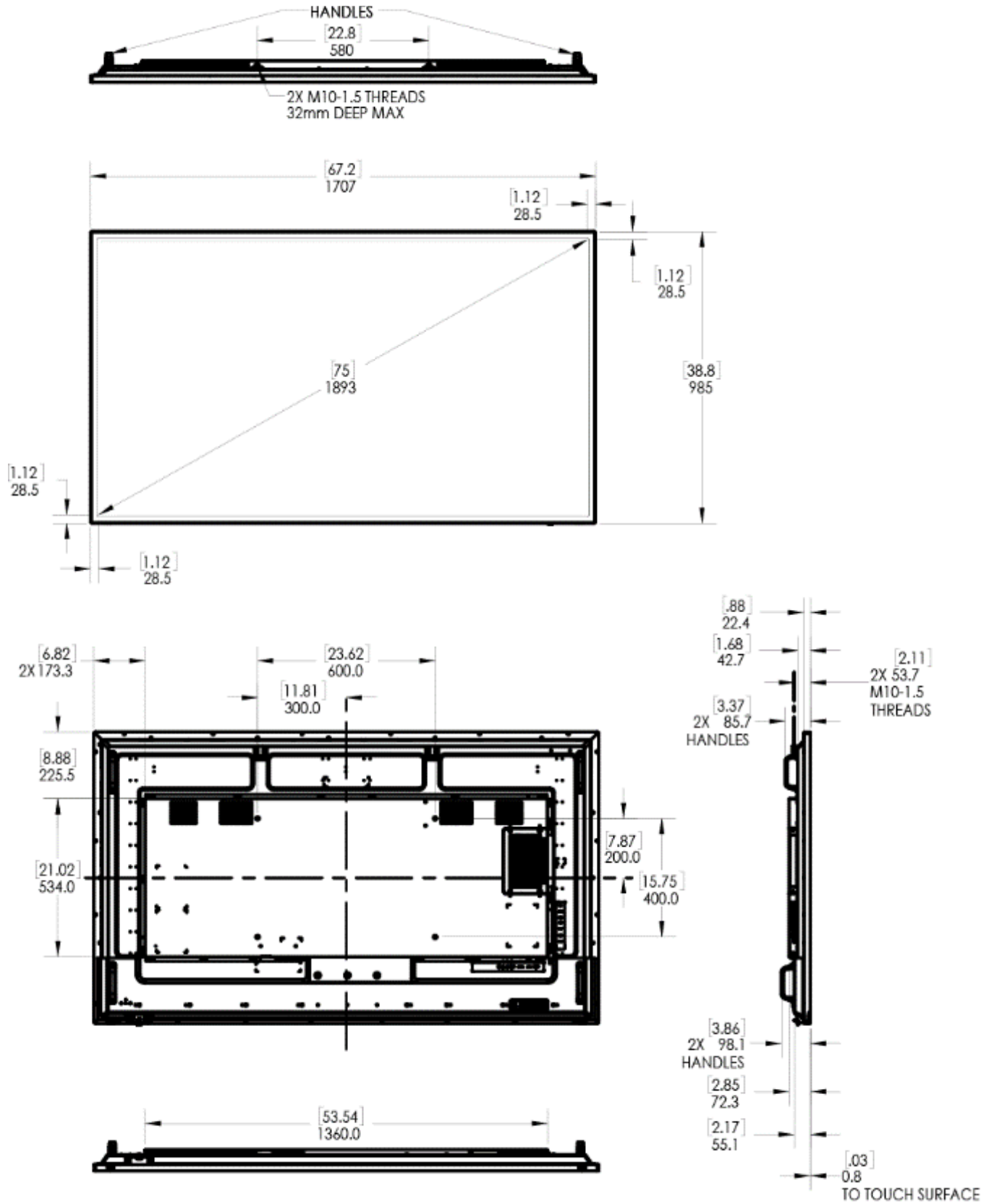

SLM862

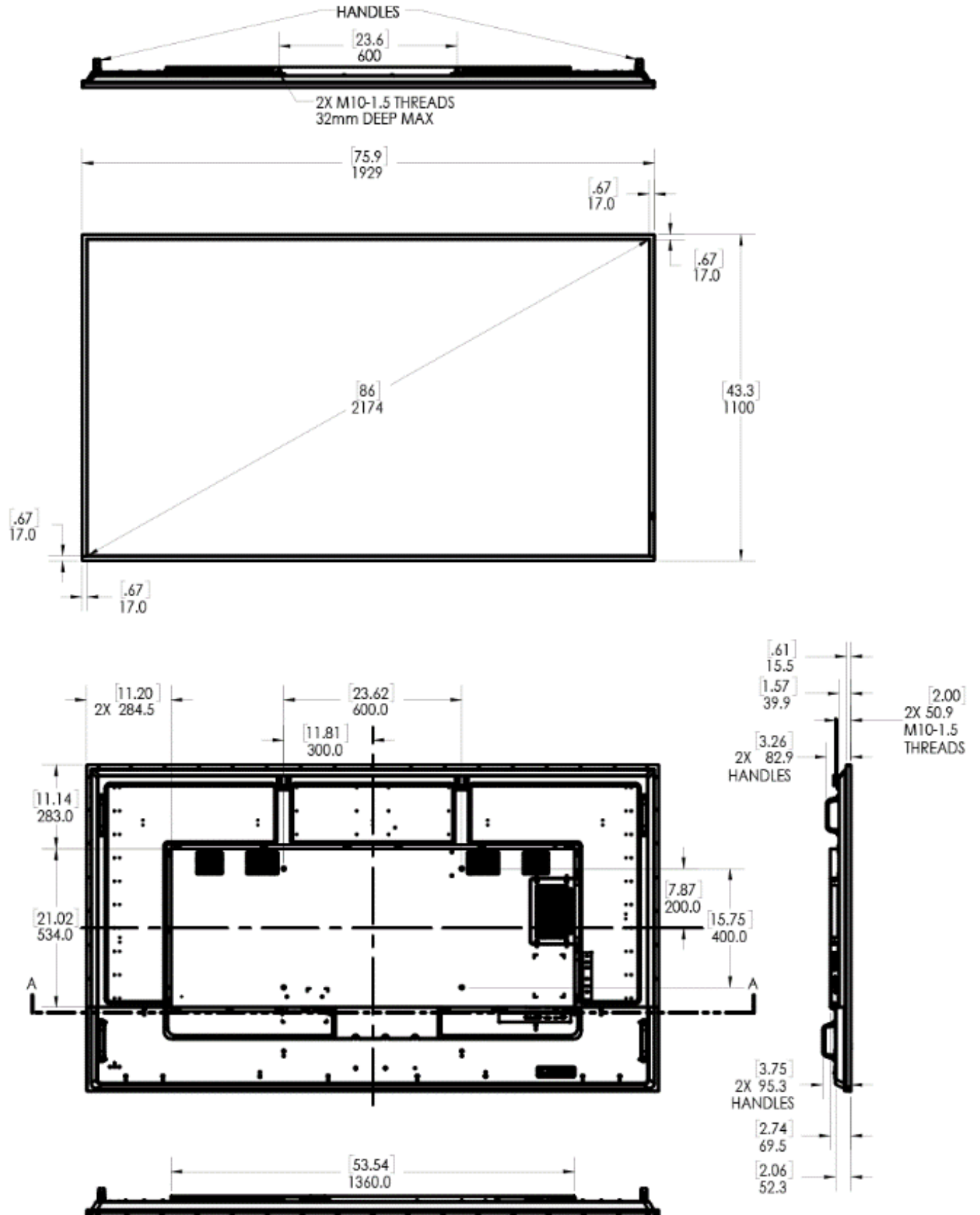

SLM862-T

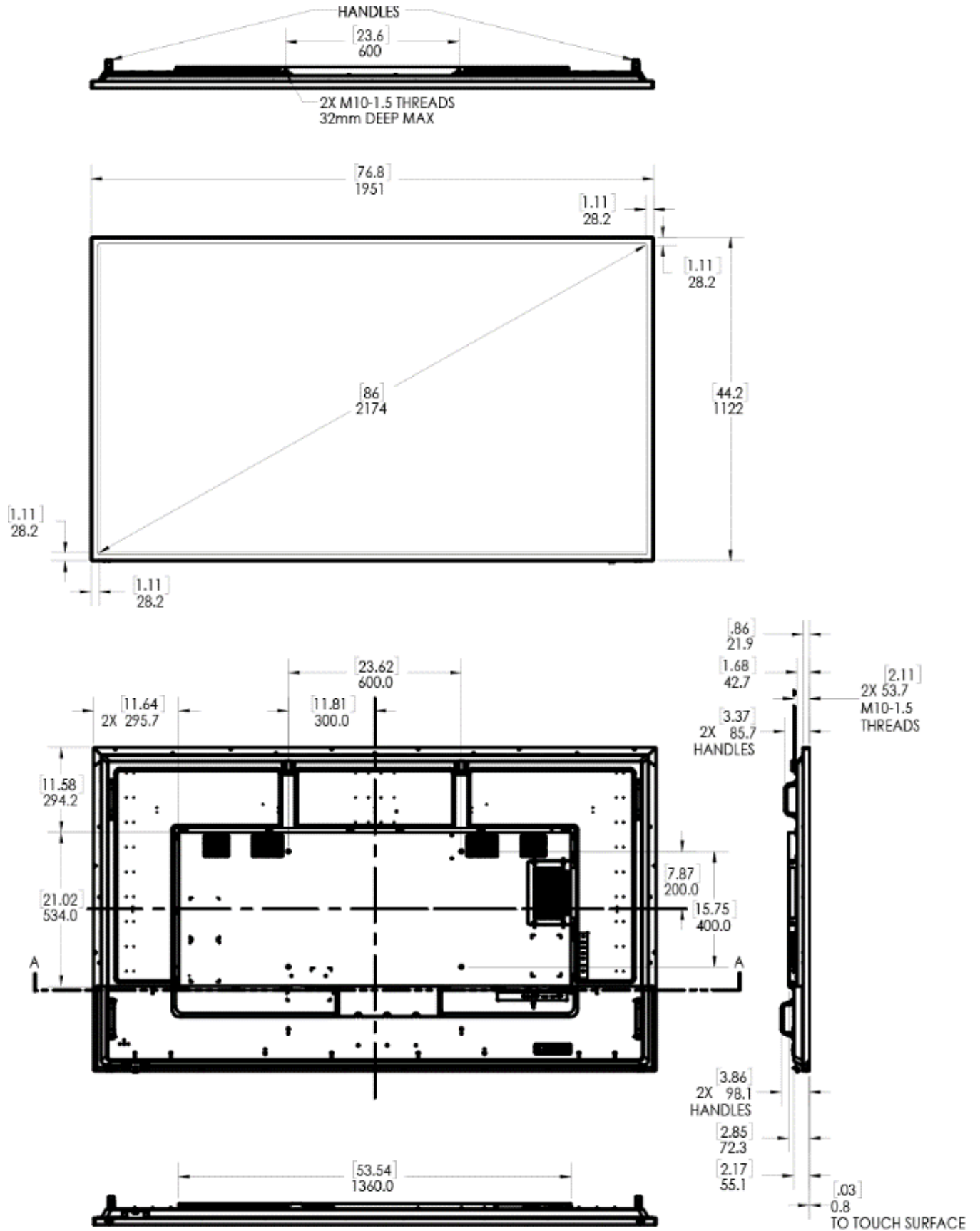

Troubleshooting

Before calling service personnel, please check the following table for a possible cause of the problem you are experiencing. Please note the following:

- Perform the adjustments according to "Operating the Display" on page 28.
- If the problem you are experiencing is not described below, or you cannot correct the problem, stop using the display and contact Planar's Technical Support Department. See "Accessing the Planar Technical Support Website" on page 123.

Issue	Check for the following
No image is displayed	Make sure the correct source is selected.
	Make sure the main power switch is ON.
	Check that the source equipment is operating correctly.
	Make sure the input signal is compatible with this display.
The image is not centered	Make sure the input signal is compatible with this display.
The remote control doesn't work	Make sure the batteries are new and installed correctly. Ensure the remote is aimed at the IR sensor.
	Make sure the remote control sensor is plugged in correctly.
	Make sure the remote is aimed towards the back of the display where the sensor is located.
The picture color looks poor	Check the picture settings. Reset the display

Accessing the Planar Technical Support Website

Go to <http://www.planar.com/support/> to locate the following support documents and resources:

- User Guide
- RS232 User Manual
- Standard Warranties
- Planar support hotline number and email

Index

A

- Accessory Kit, 19
- Advanced Settings, 61
- Advanced Settings Reset, 66
- Android Settings Menu, 67
- Aspect Ratio, 51
- Audio, 53
 - Audio Out, 54
 - Audio Reset, 54
- Audio Compatibility, 90

B

- batteries, 18

C

- Cable Clips, 18, 19
- Cable Length Recommendations, 27
- Cleaning the Display, 16
- Color Subsampling Support, 105
- Configuration 1, 55
 - Reset, 57
- Configuration 2, 58
 - Reset, 60
- Content Management System, 102
- Cooling Requirements, 13
- Custom Zoom, 52

D

- Dimensions, 110

E

- Ethernet, 69
- External Control, 103

F

- Factory Reset, 57

H

- HDMI
 - Installing the Display, 27
 - Package contents, 17

I

- Image Compatibility, 91
- Important Waste Disposal Information, 13
- Input Menu, 46
- Installing the Display, 26
- IR commands, 32

L

- LED Indicators, 30

M

- Manual Setup
 - Signage Display Settings, 41
- Media Player, 90
- Monitor ID, 59

N

- Normal Usage Guidelines, 13

O

- Operating the Display, 28
- OSD Initial Settings Menu, 40
 - Keypad, 28
 - Main Menu, 48

P

- Package Contents, 17
- Pairing the Remote Control, 36
- Plan Your Installation, 26
- Power Delivery, 108
- Power Down Mode, 66

R

- Remote Control Receiver, 29

S

- Safety, 7
- Safety Instructions, 8
- Schedule, 63
- Screen Reset, 52
- Signage Display, 70
 - Settings, 41
- Signal Compatibility, 104
- Source Options, 46
- Supported Media Formats, 90

T

- Temporary Image Retention, 12
- Troubleshooting, 122

V

- VESA Mounts, 15
- Volume, 29, 37, 53, 54, 61

W

- Warranty Coverage, 12