

EP5804K/EP5804K-T, EP6504K/EP6504K-T User Guide



PLANAR

Planar utilizes HDMI® standards in this product.

The terms HDMI, HDMI High-Definition Multimedia Interface, HDMI Trade dress and the HDMI Logos are trademarks or registered trademarks of HDMI Licensing Administrator, Inc.

Copyright © 20 Aug 2014 by Planar Systems, Inc. All rights reserved.
Contents of this publication may not be reproduced in any form without permission of Planar Systems, Inc.

Trademark Credits

Windows™ is a trademark of Microsoft Corp.
All other companies are trademarks or registered trademarks of their respective companies.

Disclaimer

The information contained in this document is subject to change without notice. Planar Systems, Inc. makes no warranty of any kind with regard to this material. While every precaution has been taken in the preparation of this manual, the Company shall not be liable for errors or omissions contained herein or for incidental or consequential damages in connection with the furnishing, performance, or use of this material.

Warranty and Service Plans

Planar warranty and service plans will help you maximize your investment by providing great support, display uptime, and performance optimization. From post-sale technical support to a full suite of depot services, our services are performed by trained Planar employees. When you purchase a Planar product, you get more than a display, you get the service and support you need to maximize your investment. To find the latest warranty and service information regarding your Planar product, please visit <http://www.planarcontrolroom.com/support>

RoHS Compliance Statement

The Planar EP-Series is fully RoHS compliant.

Part Number: 020-1269-00

Table of Contents

- EP5804K/EP5804K-T, EP6504K/EP6504K-T User Guide**..... i

- Introduction**1
 - Safety Information2
 - Safety Precautions.....2
 - Recommended Usage4
 - VESA Mounts, General Description6
 - Cleaning the Display7

- Package Contents**.....8
 - Unpacking the Display8
 - Installing the Cable Clips 12

- Dimensions** 13
 - EP5804K 13
 - EP5804K - T 14
 - EP6504K 15
 - EP6504K - T 16
 - Planar EP Series - Standard Inputs..... 17

- Installing the Display** 18
 - Before You Begin..... 18
 - Installing OPS Expansion (Optional)..... 19

- Operating the Display** 20
 - OSD Keypad..... 20
 - Remote Control Receiver 21

LED Indicators	22
Using the Display in Portrait Mode.....	22
Using the Remote Control	23
Turning the Display On.....	26
Turning the Display Off.....	27
Adjusting the Volume	27
Selecting the Input Source	28
OSD Menu Functions.....	29
OSD Menus	37
Navigating Through the Menus.....	41
Using the Touch Screen	63
Performing basic functions	63
Touchscreen MultiTouch Driver Installation	65
Touchscreen (PQLabs) MultiTouch Platform Content	65
Uninstalling the MultiTouch Driver	66
Multi-Touch Functions	66
LAN Control.....	67
Supported Operating Systems.....	67
Installation.....	68
Configuring VCOM	71
Function Descriptions	73
Setting Up Email Alerts	77
Login	77
Administrator	79
TCP Mode, UDP Mode and UART.....	82
SMTP	82

Reset Device	83
Signal Compatibility	84
Specifications	86
Troubleshooting	89
Accessing Planar's Technical Support Website	90

Introduction

The ultra HD resolution Planar EP-Series LCD displays offer best-in-class reliability with the stunning image quality of 4K resolution. Available in 58" (EP5804K/EP5804K-T) and 65" (EP6504K/EP6504K-T), the displays come standard with commercial-grade features required for digital signage, corporate, and control room environments.

Also available in touch versions, ultra HD Planar EP-Series displays bring interactivity to the 4K immersive experience.

Caution: This manual is intended for use by qualified service persons and end users with experience installing LCD displays.

Safety Information

Before using the Planar EP-Series, please read this manual thoroughly to help protect against damage to property, and to ensure personnel safety.

- Be sure to observe the following instructions.
- For your safety, be sure to observe ALL the warnings detailed in this manual.
- For installation or adjustment, please follow this manual's instructions, and refer all servicing to qualified service personnel.

Safety Precautions

- **If water is spilled or objects are dropped inside the display, remove the power plug from the outlet immediately.** Failure to do so may result in fire or electrical shock. Contact your dealer for inspection.
- **If the display is dropped or the chassis is damaged, remove the power plug from the outlet immediately.** Failure to do so may result in fire or electrical shock. Contact your dealer for inspection.

WARNING! Wall mounts must be secure.

- **If the display is hung on a wall, the wall must be strong enough to hold it.** Simply mounting it to wallboard or wall paneling won't be adequate or safe.

Caution: The screen could be damaged by heavy pressure.

- **Slight pressure on the LCD will cause distortion of the image.** Heavier pressure will cause permanent damage. Displays should be mounted where viewers cannot touch the screen or insert small objects in the openings that will create hazards by contacting bare conductive parts.

Caution: The front polarizer is soft and subject to scratches from sharp objects.

- **The polarizer is a thin sheet of film laminated to the outside layer of glass on the LCD screen.** Take care when handling items near the screen.
- **If the power cord or plug is damaged or becomes hot, turn off the main power switch of the display. Make sure the power plug has cooled down and remove the power plug from the outlet.** If the display is still used in this condition, it may cause a fire or an electrical shock. Contact your dealer for a replacement.

Important Safety Instructions

- 1** Read these instructions.
- 2** Keep these instructions.
- 3** Heed all warnings.
- 4** Follow all instructions.
- 5** Do not use the display near water.
- 6** Clean the LCD screens with an LCD screen cleaner or LCD wipes.
- 7** Do not install near any heat sources such as radiators, heat registers, stoves or other apparatus (including amplifiers) that produce heat.
- 8** Do not defeat the safety purpose of the polarized or grounding type plug. A polarized plug has two blades with one wider than the other. A grounding type plug has two blades and a third grounding prong. The wide blade or the third prong is provided for your safety. When the provided plug does not fit into your outlet, consult an electrician for the replacement of the obsolete outlet.
- 9** Protect the power cord from being walked on or pinched, particularly at plugs, convenience receptacles and the point where they exit from any of the displays.
- 10** Only use the attachments/accessories specified by the manufacturer.
- 11** Unplug all displays during lightning storms or when unused for long periods of time.
- 12** You must follow all National Electrical Code regulations. In addition, be aware of local codes and ordinances when installing your system.
- 13** Refer all servicing to qualified service personnel. Servicing is required when any of the displays have been damaged in any way. For example, if the AC power cord or plug is damaged, liquid has been spilled or objects have fallen into a display, the displays have been exposed to rain or moisture, do not operate normally or have been dropped.
- 14** Keep the packing material in case the equipment should ever need to be shipped.
- 15** Wall mounts must be secure. The wall must be strong enough to hold all displays, brackets and cables.

- 16 Slight pressure on the LCD will cause distortion of the image. Heavier pressure will cause permanent damage. Displays should be mounted where viewers cannot touch the screen or insert small objects in the openings that will create hazards by contacting bare conductive parts.
- 17 The front polarizer is soft and subject to scratches from sharp objects. The polarizer is a thin sheet of film laminated to the outside layer of glass on the LCD screen. Take care when handling items near the screen.

Recommended Usage

In order to get the most out of your LCD, use the following recommended guidelines to optimize the display.

Burn-In Versus Temporary Image Retention

Burn-in causes the screen to retain an image essentially forever, with little or no way to correct the problem. Under normal use, an LCD will not experience burn-in, as plasma displays do, nor will it retain images in any way.

Normal use of an LCD is defined as displaying continuously changing video patterns or images. However, LCDs can experience *temporary* image retention when recommended usage guidelines are not followed.

What is Temporary Image Retention?

Temporary image retention (TIR) can occur when a static image is displayed continuously for extended periods of time (12 hours or longer). An electrical charge differential may build up between the electrodes of the liquid crystal, which causes a negative-color video image (color-inverted and brightness-inverted version of the previous image) to be retained when a new image is displayed. This behavior is true for any LCD device from any LCD manufacturer.

TIR is not covered under warranty. See standard warranty terms and conditions for details. Here are some guidelines to help you avoid TIR:

- Use the LCD to show a screen saver, moving images or still pictures that change regularly. When using high-contrast images, reposition the images frequently.
- Turn off the LCD when it is not in use. To use your source computer's Power Options Properties, set up your computer to turn off the display when not in use.

Caution: For optimal performance, we suggest turning off the backlight power on the display for six hours per day.

European Union Disposal Information

English

- Disposal of old Electrical & Electronic Equipment (Applicable throughout the European Union and other European countries with separate collection programs)

This symbol found on your product or on its packaging, indicates that this product should not be treated as household waste when you wish to dispose of it. Instead, it should be handed over to an applicable collection point for the recycling of electrical and electronic equipment. By ensuring this product is disposed of correctly, you will help prevent potential negative consequences to the environment and human health, which could otherwise be caused by inappropriate disposal of this product. The recycling of materials will help to conserve natural resources.



This symbol is only valid in the European Union. If you wish to discard this product, please contact your local authorities or dealer and ask for the correct method of disposal.

Español

- Deshecho de equipos eléctricos y electrónicos (aplicable a la Unión Europea y a otros países europeos con programas de reciclaje independientes)

La presencia de este símbolo en el propio producto o en su material de embalaje, indica que no se debe tratar como residuo doméstico cuando desee deshacerse de él. En su lugar, debe entregarlo en el punto limpio correspondiente de reciclaje de equipos eléctricos y electrónicos. Asegurándose de que este producto se desecha de forma correcta, ayudará a evitar posibles consecuencias negativas para la conservación del medioambiente y la salud humana, consecuencias que podrían darse si se desecha del producto de forma inadecuada. El reciclado de materiales ayuda a conservar los recursos naturales.



Este símbolo solamente es válido en la Unión Europea. Si desea deshacerse de este producto, póngase en contacto con las autoridades locales o con su distribuidor y pida información sobre el método de disposición adecuado.

Português

- Eliminação de equipamentos eléctricos e electrónicos usados (aplicável na União Europeia e noutros países europeus com programas próprios de recolha destes equipamentos)

Este símbolo, colocado no produto ou na respectiva embalagem, indica que o produto não deve ser tratado como lixo doméstico aquando da sua eliminação. Em vez disso, deve ser entregue num ponto de recolha de equipamentos eléctricos e electrónicos para posterior reciclagem. Ao garantir a correcta eliminação deste produto, estará a evitar consequências potencialmente negativas tanto para o ambiente como para a saúde humana. A reciclagem de materiais ajuda a preservar os recursos naturais.



Este símbolo apenas é válido na União Europeia. Se quiser eliminar este produto, contacte as entidades locais ou o seu fornecedor para ficar a saber qual o método de eliminação correcto.

Svenska

- Avfall av förbrukad elektrisk och elektronisk utrustning (Tillämpbart i hela Europeiska unionen och andra europeiska länder med separata samlingsprogram)

Den här symbolen som finns på din produkt eller på dess förpackning påvisar att produkten inte ska behandlas som hushållsavfall när du vill slänga bort den. Istället ska den lämnas över till en lämplig uppsamlingspunkt för återvinning av elektriska och elektroniska utrustningar. Genom att tillförsäkra att den här produkten återvinns på ett riktigt sätt hjälper du till med att förhindra möjliga negativa konsekvenser för miljön och mänsklig hälsa. Det kan annars orsakas på grund av olämplig sophantering av den här produkten. Återvinning av material kommer att hjälpa till att bevara naturtillgångar.



Den här symbolen är endast giltig inom den Europeiska unionen. Om du vill slänga bort den här produkten ska du kontakta lokala myndigheter eller återförsäljare, och fråga efter lämplig avfallsmetod.

Français

- Mise au rebut des équipements électriques et électroniques usagés (Valable dans l'ensemble de l'Union Européenne ainsi que dans les pays européens disposant de programmes distincts de collecte des déchets)

Ce symbole appliqué sur votre produit ou sur son emballage indique que ce produit ne doit pas être traité comme un déchet ménager lorsque vous voulez le mettre au rebut. Il doit au contraire être remis à un site de collecte agréé pour le recyclage des équipements électriques et électroniques. En veillant à ce que ce produit soit mis au rebut de façon adéquate, vous contribuerez à prévenir les conséquences potentiellement négatives sur l'environnement et sur la santé humaine qui risqueraient de se produire en cas de mise au rebut inappropriée de ce produit. Le recyclage des matériaux contribuera également à économiser les ressources naturelles.



Ce symbole n'est valable que dans l'Union Européenne. Si vous souhaitez mettre ce produit au rebut, veuillez prendre contact avec les autorités locales ou avec votre revendeur et renseignez-vous sur la méthode de mise au rebut correcte.

Italiano

- Smaltimento delle attrezzature elettriche ed elettroniche usate (applicabile in tutta la Comunità Europea ed altri Paesi Europei che applicano programmi di raccolta differenziata)

Il simbolo trovato sul prodotto, o sulla sua confezione, indica che il prodotto non può essere trattato come i domestici quando è il momento di smaltirlo. Al contrario, deve essere consegnato ad un centro di raccolta specializzato nel riciclaggio di attrezzature elettriche ed elettroniche. Assicurando che il corretto smaltimento di questo prodotto, si aiuterà a prevenire potenziali conseguenze negative sull'ambiente e sulla salute umana, che possono essere provocate da uno scorretto smaltimento di questa attrezzatura. I materiali riciclati aiuteranno a conservare le risorse naturali.



Questo simbolo è valido solo nell'Unione Europea. Per smaltire questo prodotto, mettersi in contatto con le autorità locali - o con il rivenditore - e chiedere informazioni sul corretto metodo di smaltimento.

Polski

- Usowanie zużytego sprzętu elektrycznego i elektronicznego (Dotyczy krajów Unii Europejskiej i innych krajów europejskich z oddzielnymi programami zbiórki odpadów)

Obecność tego symbolu na produkcie lub na opakowaniu z produktem oznacza, że tego produktu nie można wyrzucić razem z odpadkami domowymi. Należy go przekażać do punktu zbiórki w celu poddania recyklingowi podzespołów elektrycznych i elektronicznych. Usunięcie tego produktu w prawidłowy sposób, pomoże w zabezpieczeniu przed negatywnym wpływem odpadów na środowisko i zdrowie ludzi, powodowanym przez niewłaściwe usowanie produktu. Przetwarzanie materiałów pomaga w zachowaniu zasobów naturalnych.



Ten symbol obowiązuje wyłącznie w krajach Unii Europejskiej. Informacje dotyczące prawidłowej metody usunięcia tego produktu, można uzyskać u władz lokalnych lub u dostawcy.

Suomi

- Vanhjojen sähkö- ja elektroniikkalaitteiden hävittäminen (Soveltuva kaikilla Euroopan unionin alueella, sekä muissa Euroopan maissa, joilla on erilliset keräysohjelmat)

Jos tuotteessa tai sen pakkauksessa on tämä symboli, sitä ei pidä hävittäässä käsitellä tavallisena kotitalousjätteenä, vaan se kuuluu toimittaa sähkö- ja elektroniikkalaitteiden kierrätyspiesteseen. Varmistamalla, että tämä tuote hävitetään asiaankuullavalla tavalla autat estämään mahdollisia ympäristöllisiä ja ihmislle kaituvia negatiivisia seurauksia, joita sen vääränlainen hävittäminen voi aiheuttaa. Materiaalien kierrättäminen auttaa säilyttämään luonnonvarjoja.



Tämä symboli on voimassa ainoastaan Euroopan unionin alueella. Jos haluat hävittää tämän tuotteen, ota yhteyttä paikallisiin viranomaisiin tai jälleenmyyjään ja tiedustele asiaankuullava hävittämistoiementä.

Deutsch

- Entsorgung von elektrischen & elektronischen Altgeräten (geltend für die europäische Gemeinschaft und andere europäische Länder mit separaten Sammelprogrammen)

Dieses Symbol, zu finden auf Ihrem Produkt oder dessen Verpackung, macht Sie darauf aufmerksam, dass dieses Produkt bei der Entsorgung nicht als Hausmüll behandelt werden darf. Statt dessen sollte es an eine Sammelstelle zum Recycling von elektrischen und elektronischen Altgeräten gegeben werden. Helfen Sie mit, potenziell schädliche Einflüsse auf Umwelt und Gesundheit, die durch eine unsachgemäße Entsorgung dieses Produktes entstehen können, zu vermeiden und entsorgen Sie dieses Produkt ordnungsgemäß. Recycling hilft, natürliche Rohstoffe einzusparen.



Dieses Symbol ist nur innerhalb der europäischen Gemeinschaft gültig. Wenn Sie dieses Produkt entsorgen möchten, wenden Sie sich bitte an Ihre örtliche Behörde und fragen Sie nach der ordnungsgemäßen Entsorgungsmethode.

Nederlands

- Verwijderen van oude elektrische en elektronische apparatuur (toepasbaar in de volledige Europese Unie en andere Europese landen met afzonderlijke programma's voor afvalverzameling)

Dit symbool dat op het product of zijn verpakking is aangebracht, geeft aan dat dit product niet mag worden behandeld als huishoudelijk afval als u het wilt wegwerpen. U moet het afgeven bij een specifiek verzamelpunt voor de recyclage van elektrische en elektronische apparatuur. Door te garanderen dat u dit product op de correcte manier wegwerpt, helpt u potentiële negatieve gevolgen voor het milieu en de menselijke gezondheid, die zouden kunnen worden veroorzaakt door een onrechtmatig wegwerpen van het product, te voorkomen. De recyclage van materialen helpt het behoud van natuurlijke bronnen.



Dit symbool is alleen geldig in de Europese Unie. Als u dit product wenst weg te gooien, dient u contact op te nemen met uw lokale instanties voor details over de gepaste methode voor afvalverwijdering.

Waste Electrical and Electronic Equipment (WEEE) Directive In the European Union, this label indicates that this product should not be disposed of with household waste. It should be deposited at an appropriate facility to enable recovery and recycling. EEE complies with Directive 'Regulation on the Restriction of the Use of Certain Hazardous Substances in Electrical and Electronic Equipment'



Waste Electrical and Electronic Equipment (WEEE) Directive In the European Union, this label indicates that this product should not be disposed of with household waste. It should be deposited at an appropriate facility to enable recovery and recycling. EEE complies with Directive 'Regulation on the Restriction of the Use of Certain Hazardous Substances in Electrical and Electronic Equipment'

Waste Electrical and Electronic Equipment (WEEE) Yönergeleri Avrupa Birliği'nde bu etiket, ürünün ev elektroniği aletleri atıkları ile imha edilemeyeceğini gösterir. Kurtarmak ve geri dönüşümünü sağlamak için uygun şartlarda saklanması gerekir. EEE Yönetmeliğine Uygunluk ve Elektronik Eşyalarda Bazı Zararlı Maddelerin Kullanımın Sinirlendirilmesine Dair Yönetmelik.



Waste Electrical and Electronic Equipment (WEEE) Yönergeleri Avrupa Birliği'nde bu etiket, ürünün ev elektroniği aletleri atıkları ile imha edilemeyeceğini gösterir. Kurtarmak ve geri dönüşümünü sağlamak için uygun şartlarda saklanması gerekir. EEE Yönetmeliğine Uygunluk ve Elektronik Eşyalarda Bazı Zararlı Maddelerin Kullanımın Sinirlendirilmesine Dair Yönetmelik.

Normal Usage Guidelines

Normal use of the LCD is defined as operating in the open air to prevent heat buildup, and without direct or indirect heat sources such as lighting fixtures, heating ducts, or direct sunlight that can cause the modules to experience high operating temperatures. For all modules, do not block fans or ventilation openings. If the LCD module will be installed in a recessed area with an LCD surround or enclosure, ensure adequate openings are applied for proper air flow and ventilation.

At 3000 meters or below, the maximum ambient operating temperature for the LCD module cannot be above 40° C nor below the minimum ambient operating temperature of 0° C. If one of these conditions exists, it is up to the installer to ensure that module placement is changed, thermal shielding is provided and/or additional ventilation is provided to keep the display within its nominal operating parameters.

Cooling Requirements

For optimal performance, active cooling by the installer should be planned for when the ambient temperature at the top of the wall is predicted to be above the specified ambient temperature for the panel. Cooling may be done behind the displays and depending on the wall configuration, it may be helpful to place air ducts (AC) at every third display tall.

VESA Mounts, General Description

VESA mounts are used to secure the Planar EP-Series for display. The display can be installed using a variety of VESA mounts available through Planar. If you do not have a VESA mount and would like to purchase one, contact Planar.

If you purchased a VESA mount, you should have received a separate box with mounting supplies and an Installation manual. Follow these instructions carefully.

Keep in mind the following general installation guidelines:

- Screw length is crucial and will vary depending on the type of mount you use. Total screw length will include the penetration length plus the length required by the type of VESA mount in use.
- Mount spacers may be required to accommodate the protruding back panel of the OPS slot.

Caution: Shorter screws will result in insufficient mounting strength and longer screws could puncture parts inside the display.

- Prior to installation, make sure you know where all of the mounting points are located.
- Follow all safety precautions outlined in the VESA Installation manual.
- Verify the parts received with the list shown in the VESA Installation manual.

Cleaning the Display

If dust has collected on the power plug, remove the plug from the outlet and clean off the dust. Dust build-up may cause a fire.

Remove the power plug before cleaning. Failure to do so may result in electrical shock or damage.

Keep the following points in mind when cleaning the surface of the display:

- When the surface of the display becomes dirty, wipe the surface lightly with a soft clean cloth.
- If the surface requires additional cleaning, use LCD screen cleaner or LCD wipes, which are available at most electronics stores.
- Do not let cleaner seep into the display, as it may cause electrical shock or damage.

Package Contents

Unpacking the Display

The display is packed in a cardboard box using foam to protect it during shipping.

Before unpacking the display, prepare a stable, level and clean surface near a wall outlet.

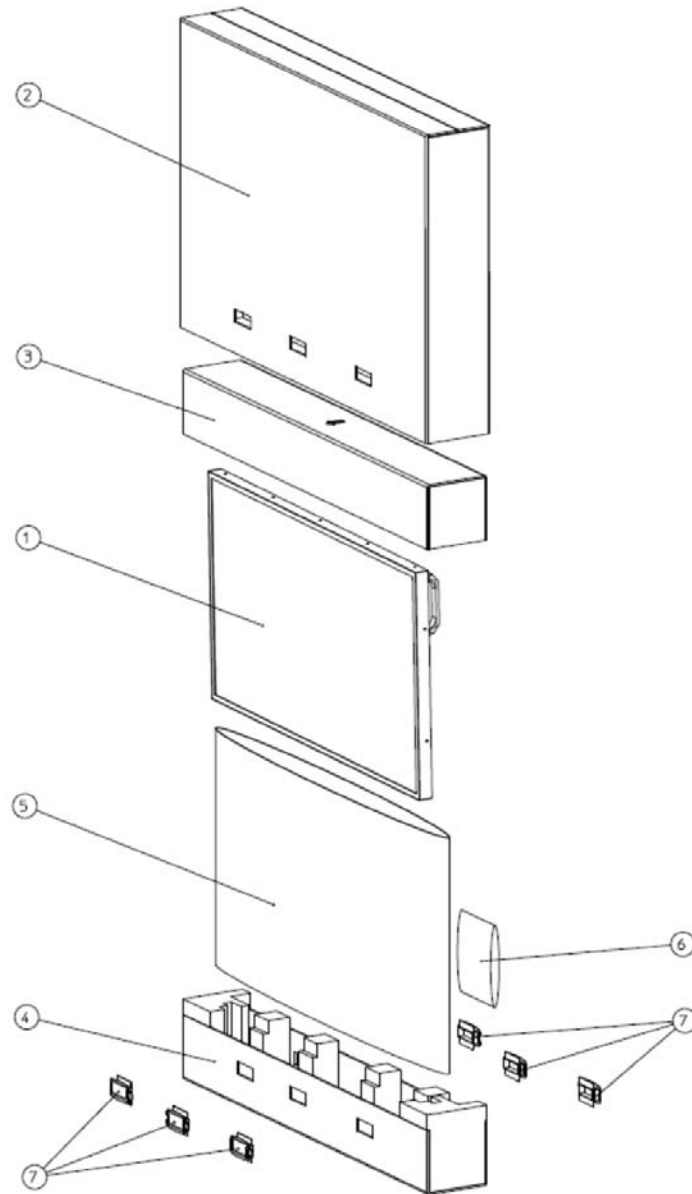

- 1** Place the LCD panel box in an upright position and remove the carton locks from the bottom first.
- 2** Remove the entire top of the box and the top shipping foam.
- 3** Remove the accessory bag and packing list.



Item	Description	Quantity
1	LCD panel	1
2	Carton	1
3	Foam Cushion Top	1
4	Foam Cushion Bottom	1
5	Polyurethane Bag	1
6	Accessory Bag	1
7	Carton Lock	6 (58") or 8 (65")

Contents of the Accessory Kit

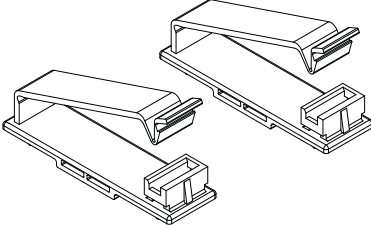
Part	Picture	Quantity
HDMI Cable		1
USB Drive		1
USB Cable (For Touch version)		1
Power cord		1
IR extender cable		1

Part	Picture	Quantity
Cable Clips	 Two white plastic cable clips, one shown from a top-down perspective and one from a side view, designed to hold cables in place.	2
OSD Remote (AAA batteries included)	 A black, handheld remote control with a red power button at the top left and various function buttons labeled with icons and text.	1

Installing the Cable Clips

The cable clips included in the Accessory Kit are used to assist with cable management. These clips snap into place as shown in the image below.

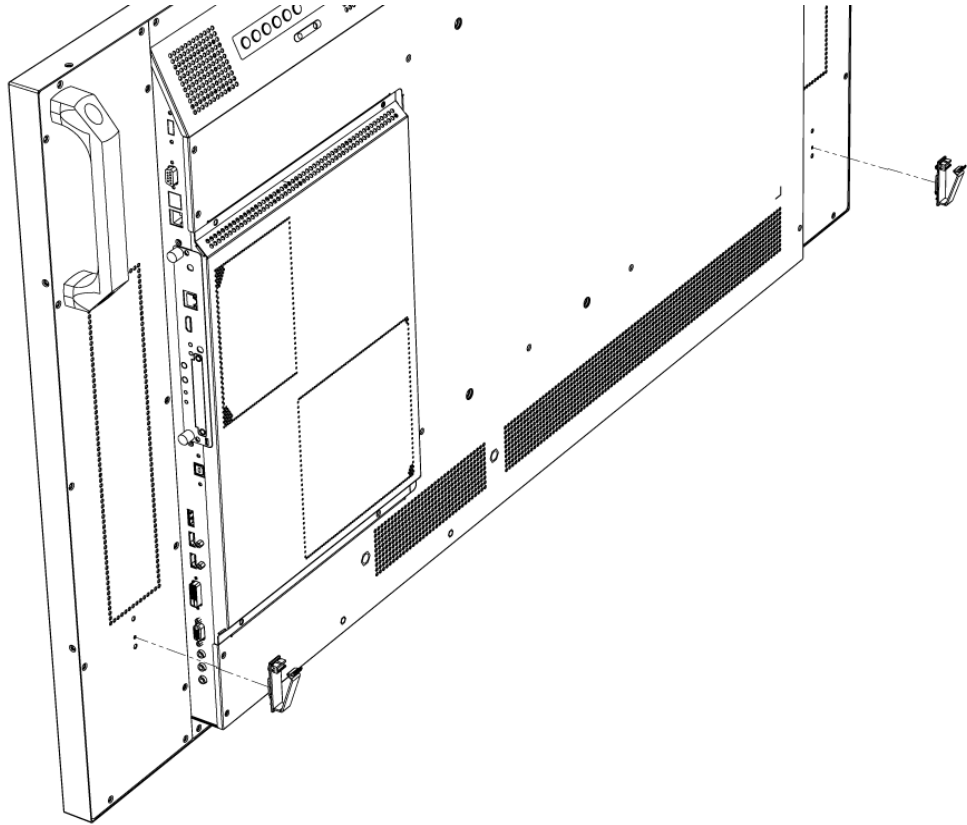

Dimensions

EP5804K

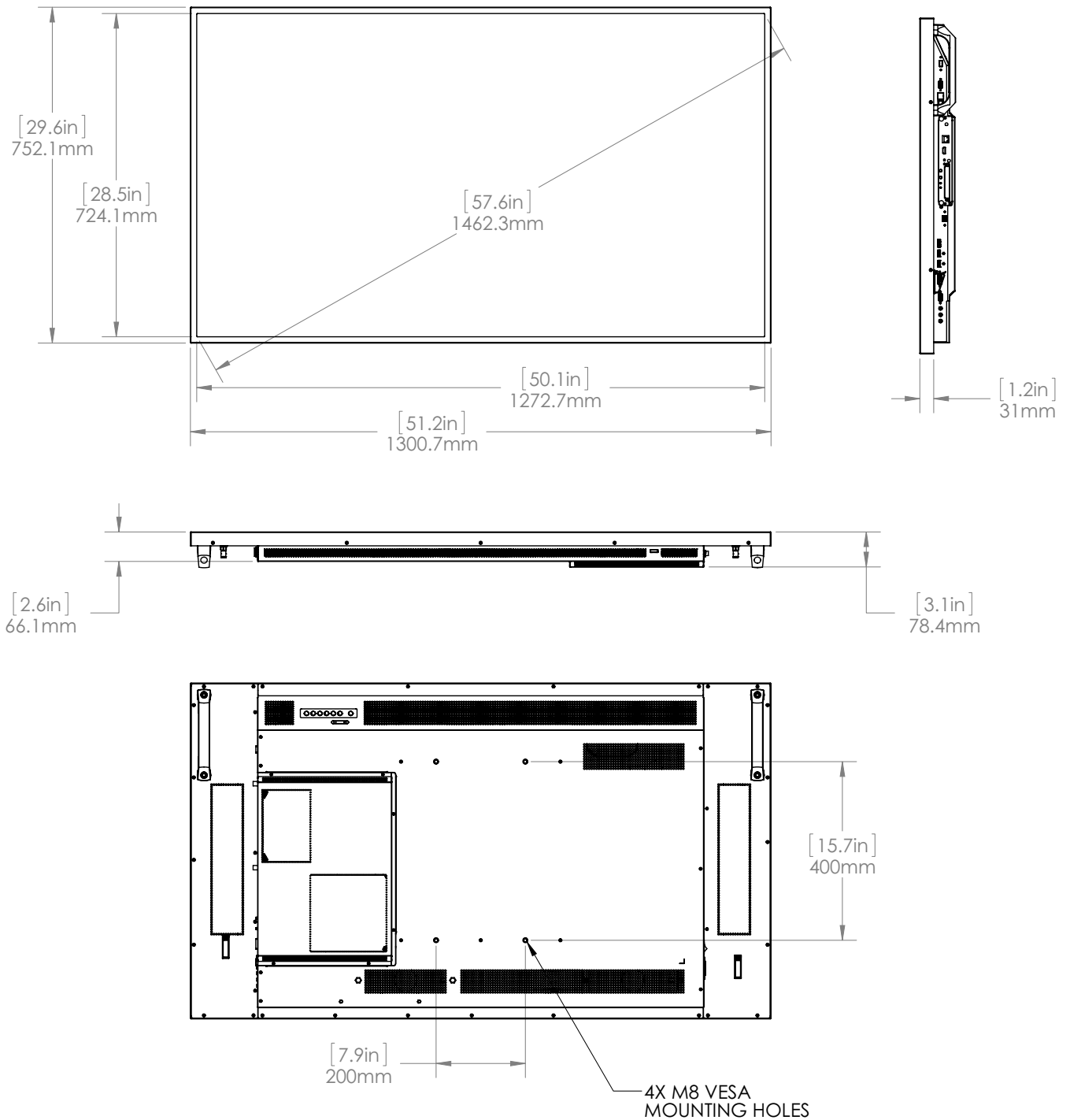

EP5804K - T

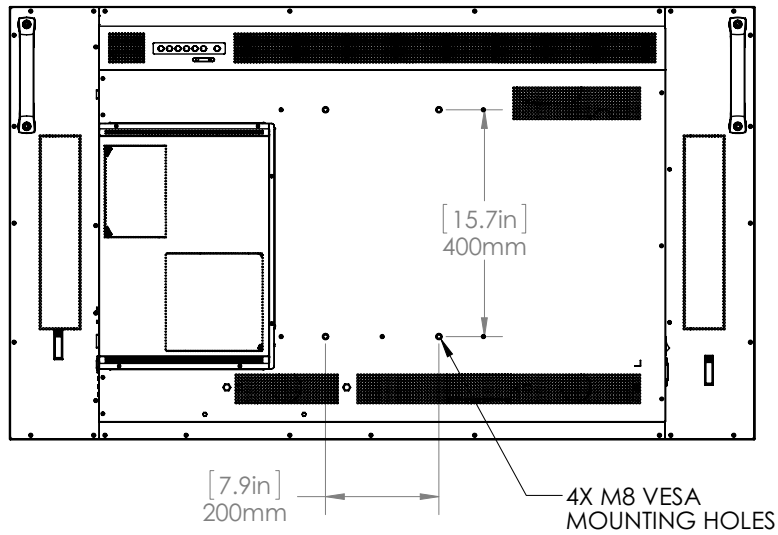
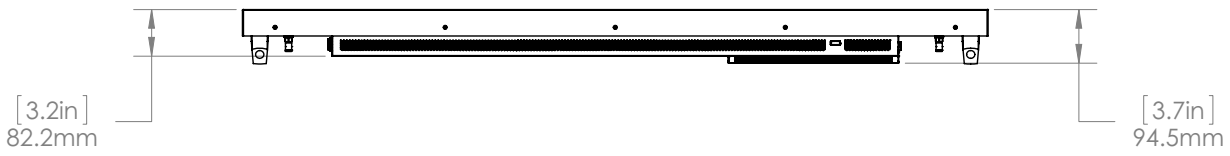
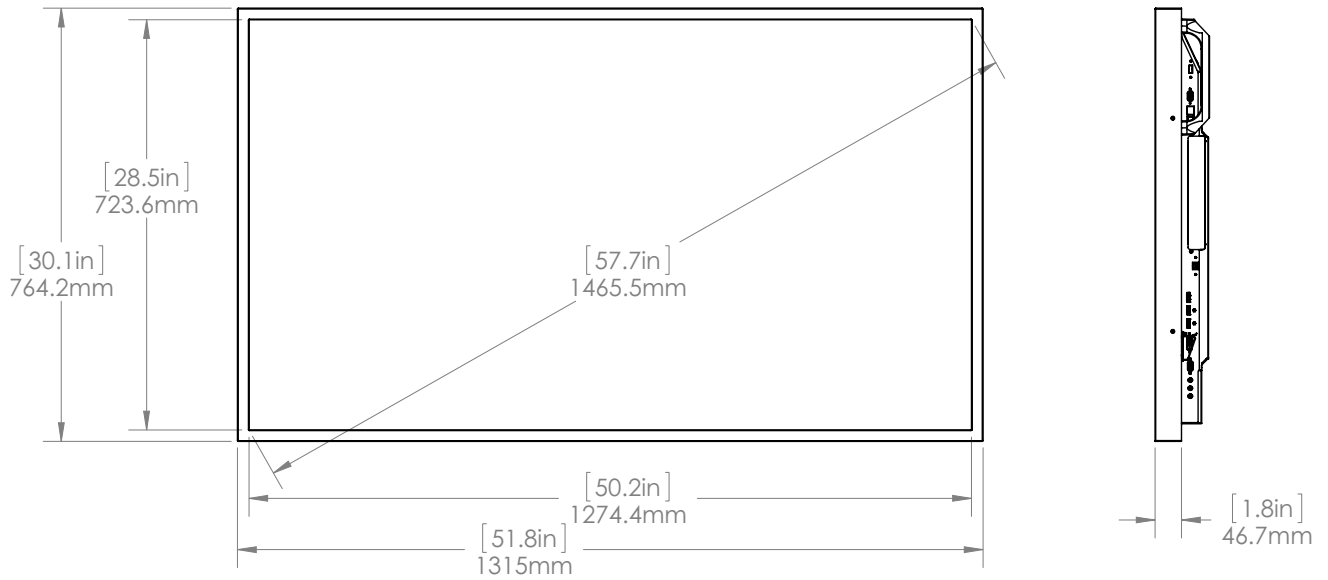

EP6504K

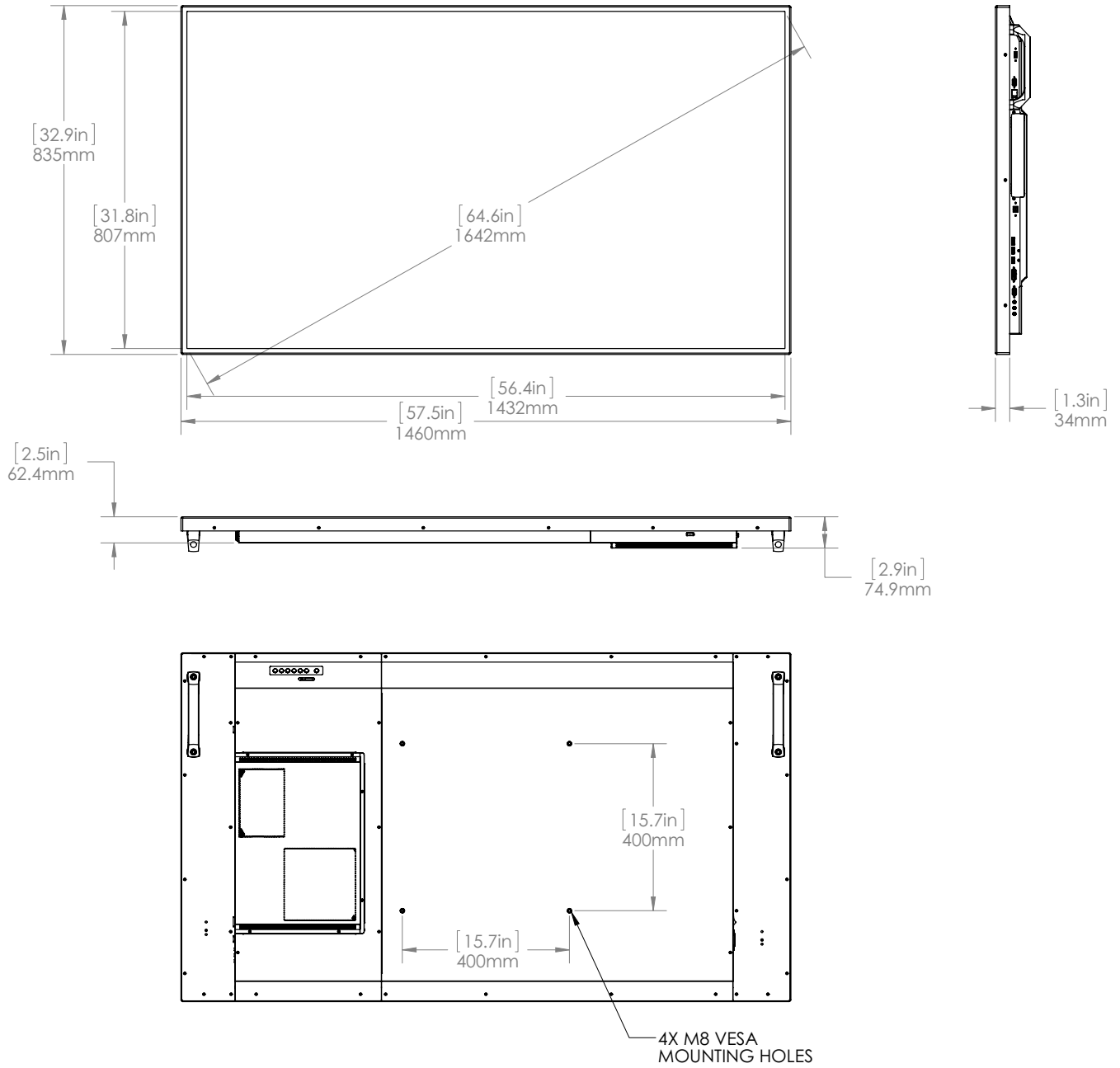

EP6504K - T

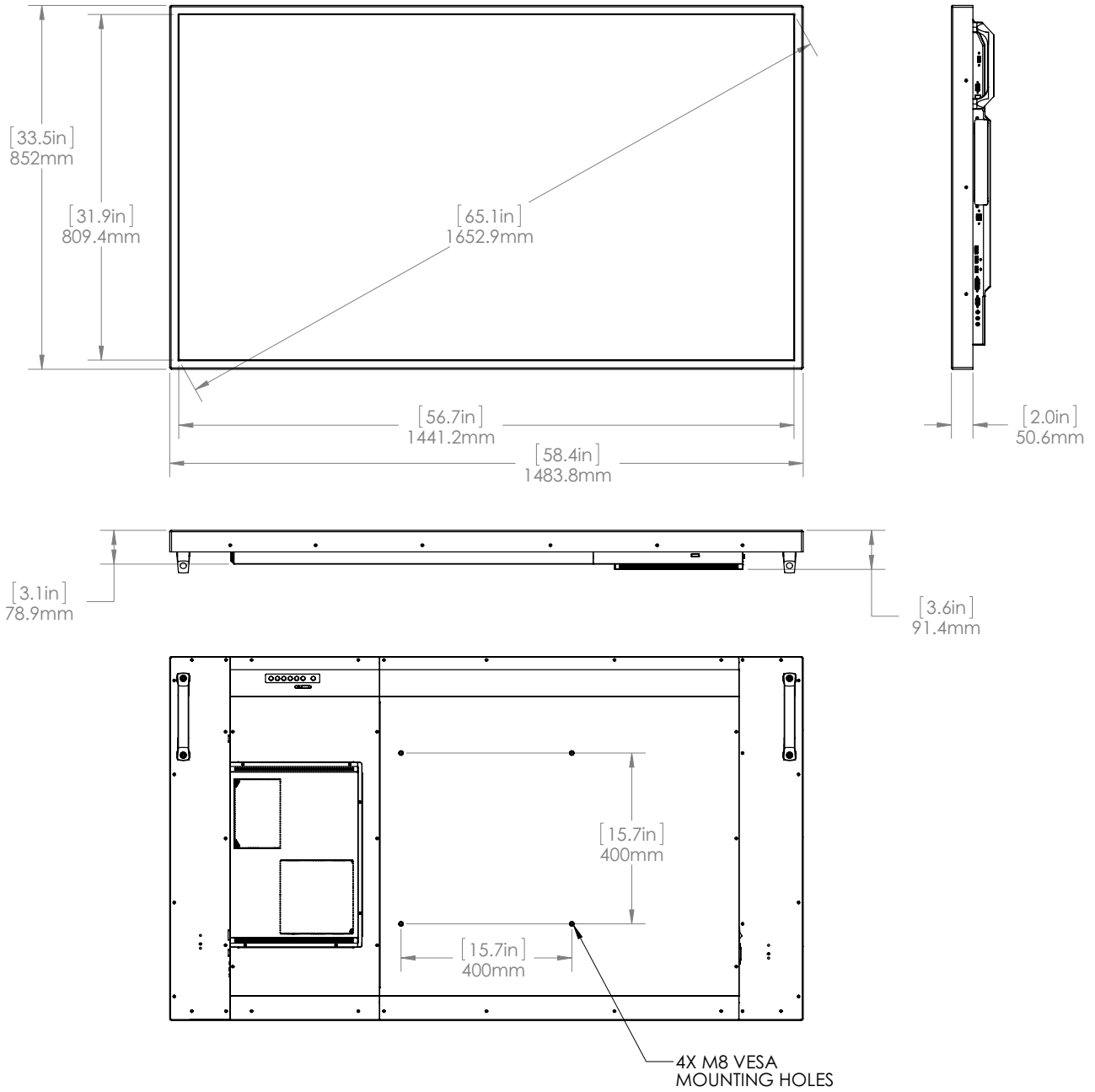

Planar EP Series - Standard Inputs

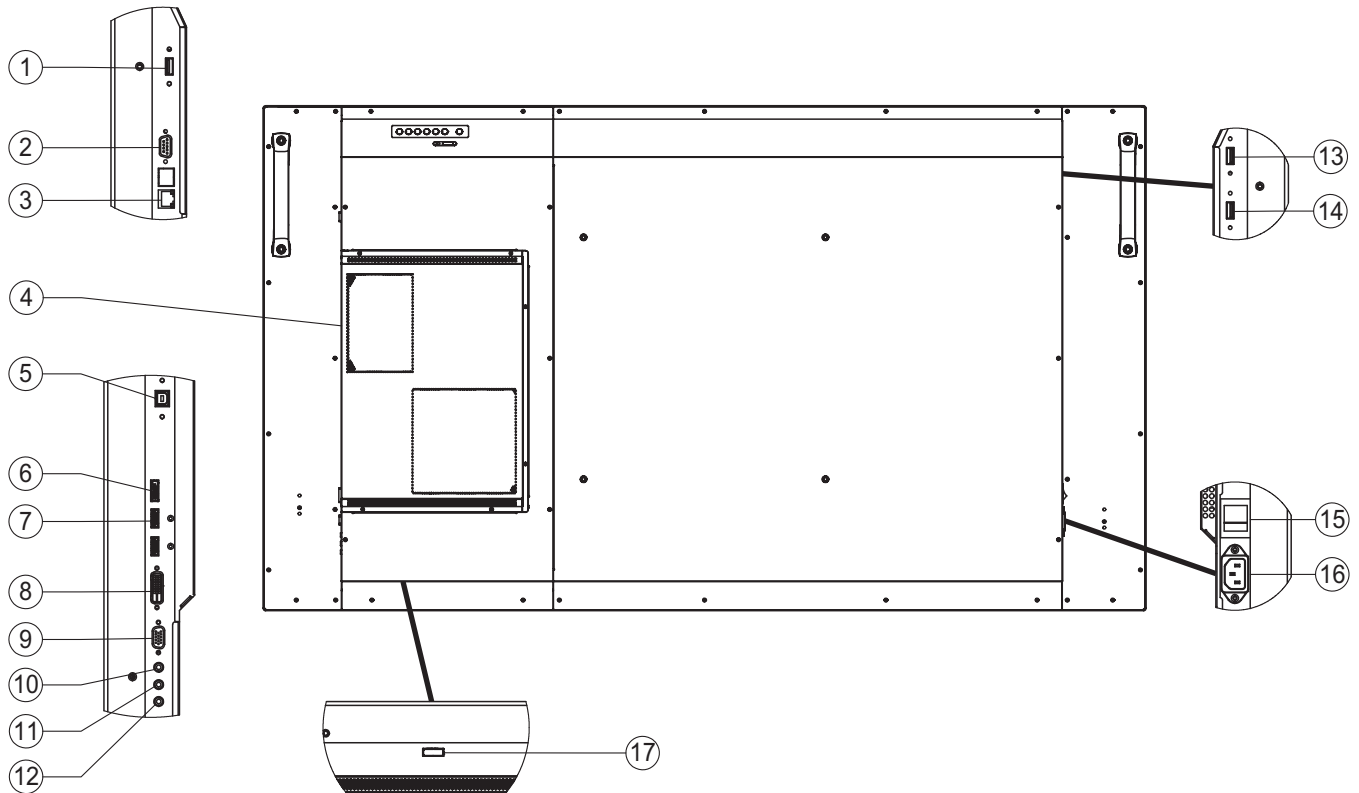

- | | | |
|------------------|---------------------|-------------------|
| ① USB 3.0* | ⑦ HDMI 1 and HDMI 2 | ⑬ USB 2.0* |
| ② RS-232 | ⑧ DVI | ⑭ USB 2.0* |
| ③ Ethernet | ⑨ VGA | ⑮ AC Switch |
| ④ OPS Slot | ⑩ PC Audio In | ⑯ AC In |
| ⑤ Touch USB** | ⑪ IR | ⑰ DisplayPort Out |
| ⑥ DisplayPort In | ⑫ Audio Out | |

Connector locations and mounting points may differ depending on the model.

* USB 2.0 and USB 3.0 ports are connected to OPS PC (when installed)

** Touch Models Only

Installing the Display

This section explains how to install your display. We suggest that you read the entire section before you attempt to install the unit.

Before You Begin

Make sure you have all the items in these lists before you begin unpacking and installing your display(s).

Tools/Equipment List

Depending on your installation, you may need one or more of the following items:

- String/string level
- Digital/laser level
- Ladders/lift
- Back brace
- Stud finder (if hanging display on a wall)

Other Things You May Need

- LCD screen cleaner or LCD wipes - available at most electronics stores
- At least two very strong people to help lift units into place

Plan Your Installation

You should have a detailed plan of how the units are to be configured. The plan should include calculations for the following:

- Power (maximum of five units per 20A circuit for 115V operation)
- Cable runs
- Ventilation and cooling requirements
- If hanging display on a wall, location of studs in the wall

Prepare Your Installation Location

You should have prepared the area where you will install the unit. If custom enclosures are part of the installation, they must be fully designed to accommodate the installation of the displays, as well as the installed unit and ventilation and cooling requirements.

If your installation included a lot of construction or dust, it is **highly recommended** that you clean all of the screens after the wall installation and configuration are complete.

Installing OPS Expansion (Optional)

The Planar EP-Series displays are equipped with an expansion slot that supports the Intel® Open-Pluggable Specification (OPS). The slot will support OPS devices such as PC's, SDI modules, HDBaseT receivers, etc.

To install an OPS device, remove the protective cover on the display and slide the device firmly into position. When installed, the OPS device will be connected internally to the display. No external video or power cables are required.

For convenience, two Type-B USB 2.0 ports and one Type-B USB 3.0 port are provided on the rear cover of the display. When an OPS device is installed, these USB ports can be used for a keyboard, webcam, USB drive, or other peripherals.

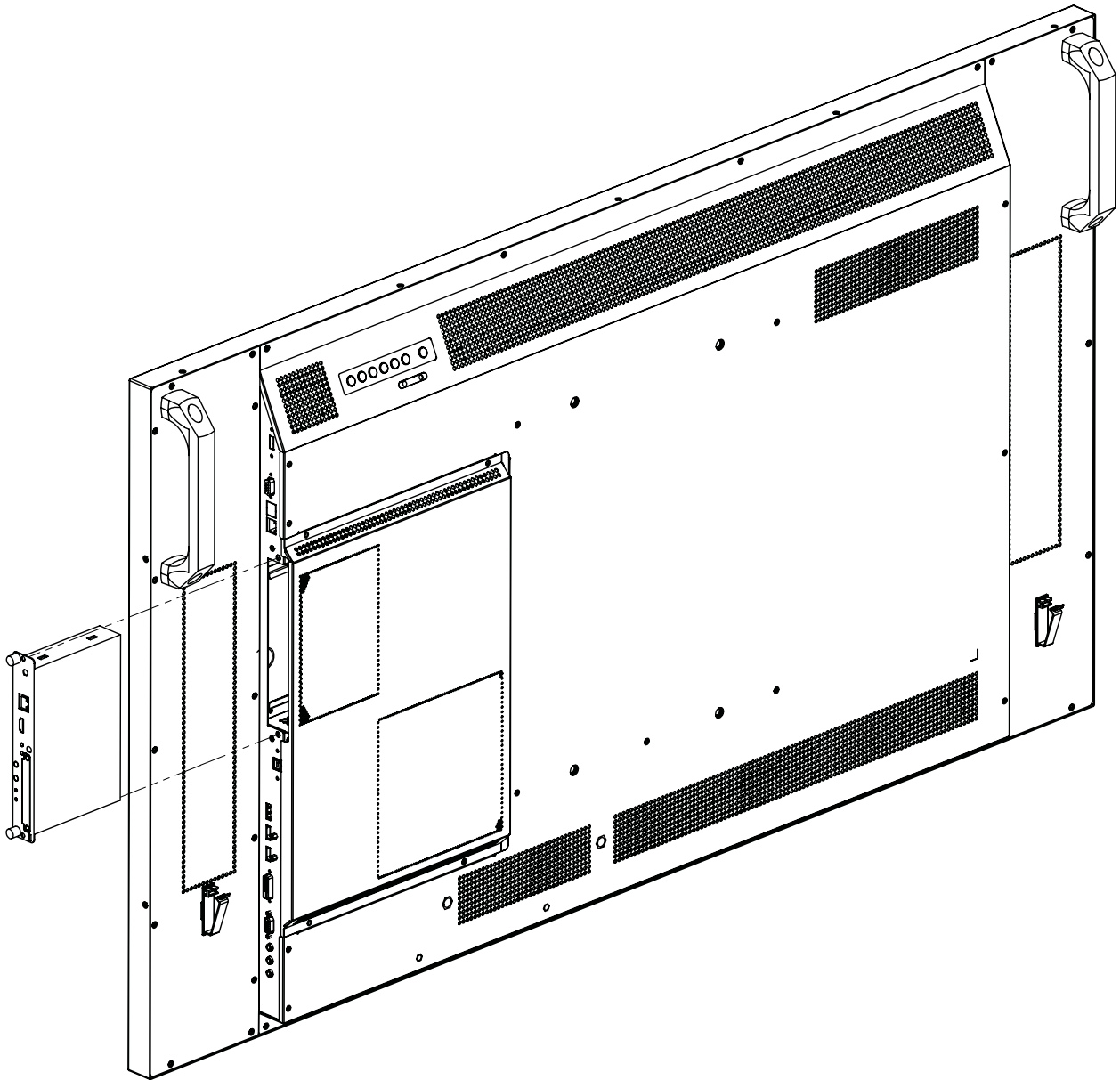

Operating the Display

OSD Keypad

The OSD keypad is located on the rear of the display.

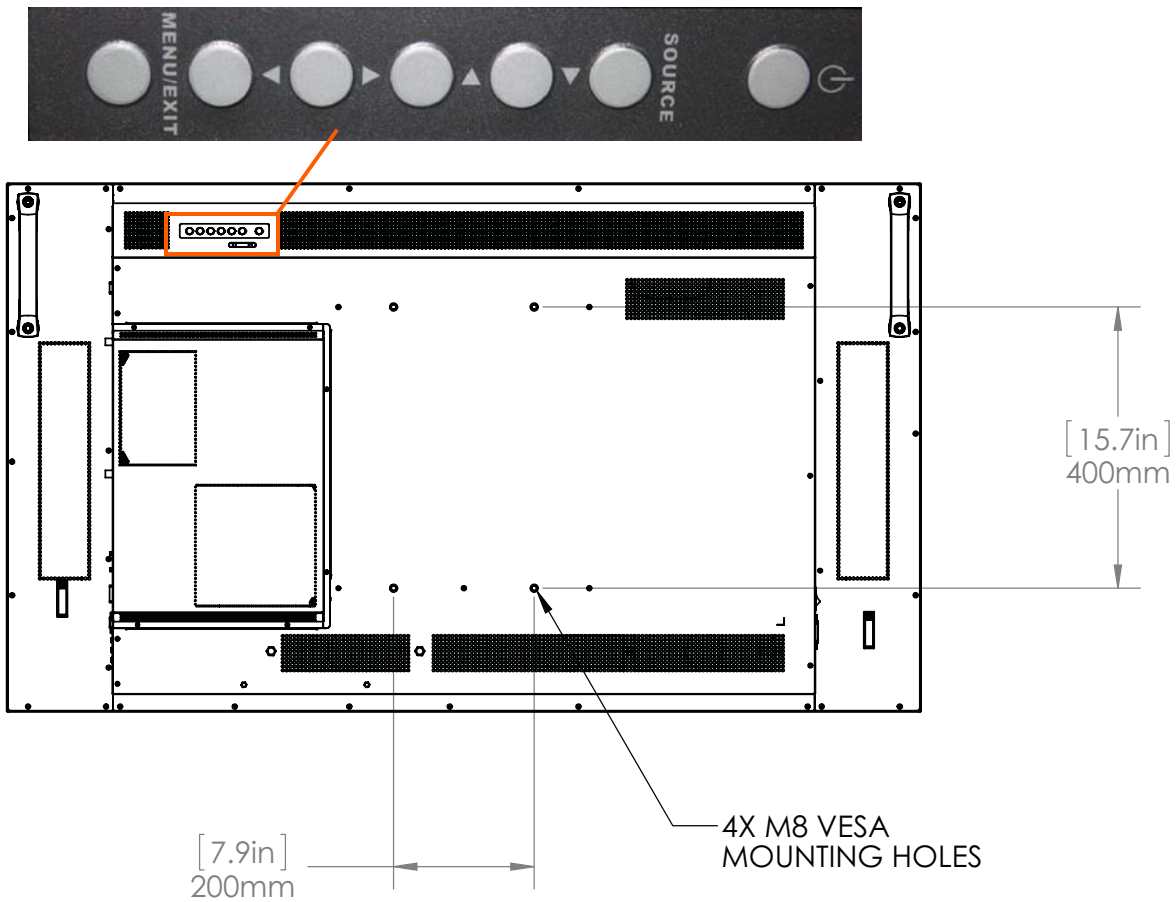

OSD Keypad Buttons

Key	Descriptions
Power	Power on/Power off
Source	Source selection (toggle)
▶	Menu Right/Increase value
◀	Menu Left/Decrease value
▲	Menu Up
▼	Menu Down
Menu/Exit	Menu/Exit

Remote Control Receiver

The remote control receiver is located near the keypad on the rear of the display. Use the IR extender cable for operating the remote from the front of the display.

Power ON standby indicator,
Remote control receiver

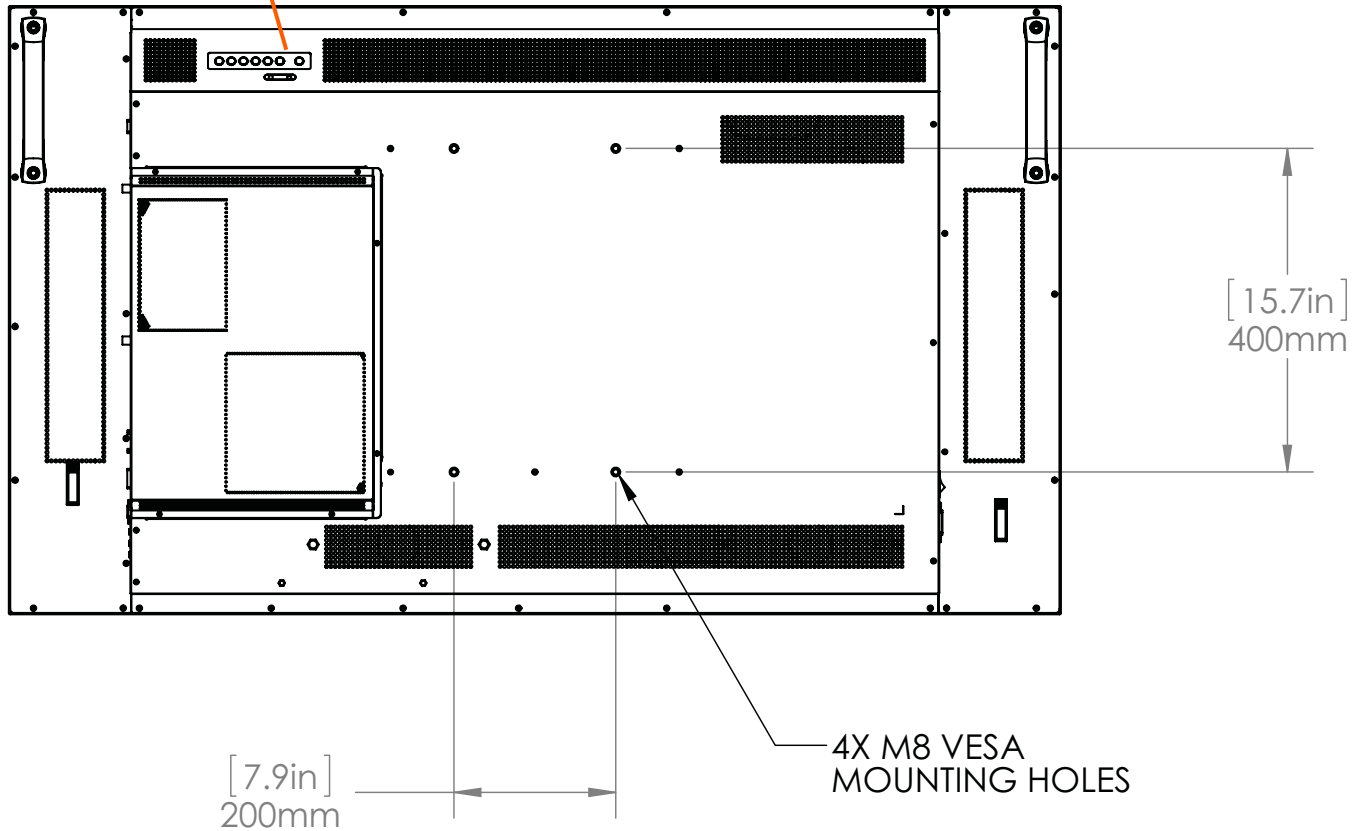

LED Indicators

The LED indicator light is located on the rear of the display near the keypad. The following table explains what the different colors and blink patterns mean.

LED On

Power Status	Condition
Green	Power on
Blinking Orange	No signal
Orange	Power saving mode
Off	AC off
Off	Power off

Using the Display in Portrait Mode





When using the display in the portrait position and looking at the rear of the display, it should be rotated according to the arrow stickers on the back of the display. This will allow for proper ventilation. Then select the OSD rotation of landscape or portrait on the OSD menu (MAIN MENU > BASIC > OSD ROTATION).

Caution: Improper ventilation may shorten the life of the display.

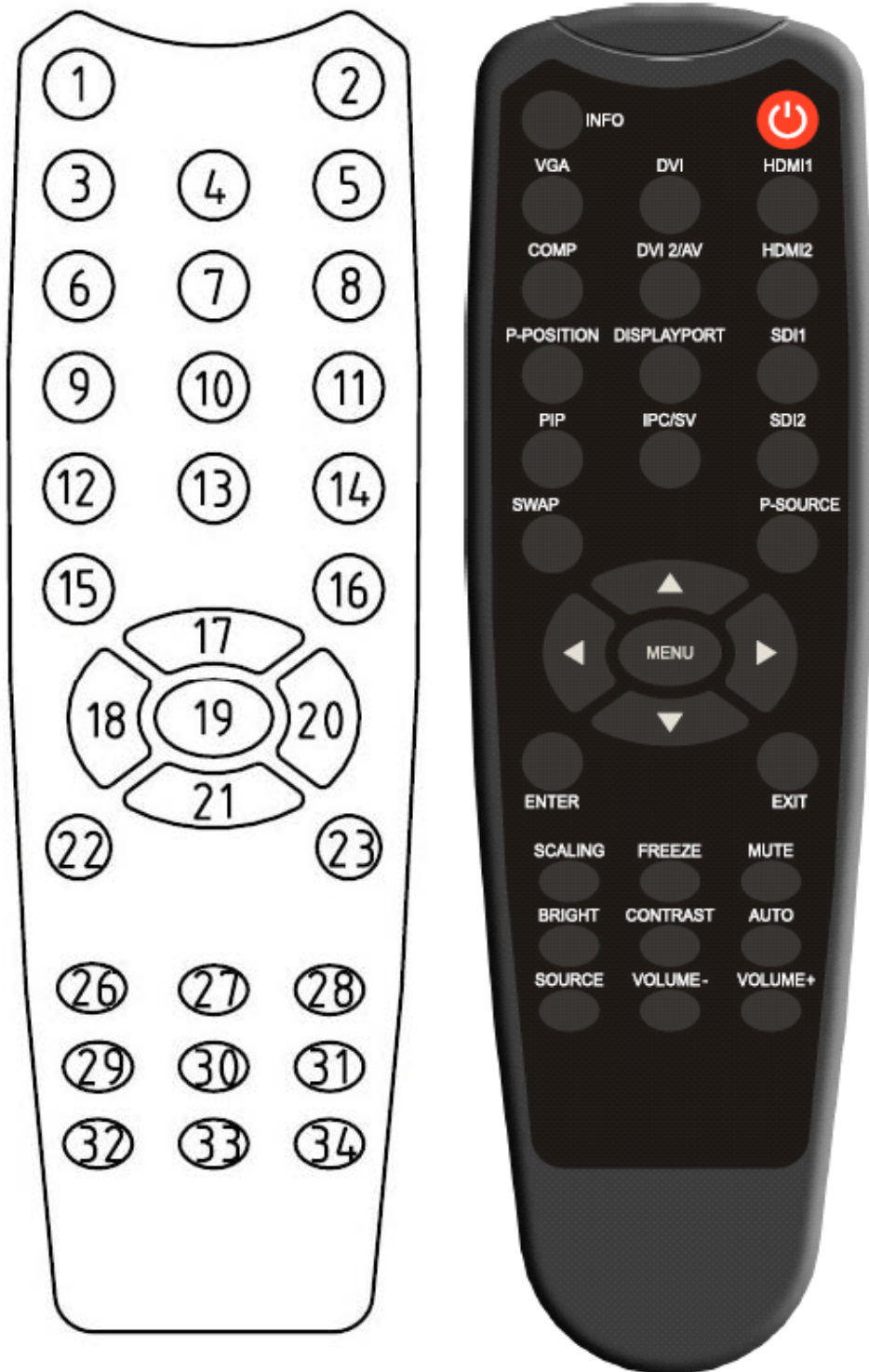
Using the Remote Control

Below is a picture of the remote control and its corresponding Hex codes. See the following page for button descriptions and Hex codes.



Num	Function	Customer Code	Hex Code	Description
1	INFO	40AF	04FB	Provides source and resolution information
2		40AF	1CE3	Turns the display on and off
3	VGA	40AF	07F8	Selects the PC's VGA source
4	DVI	40AF	08F7	Selects the PC's DVI source
5	HDMI 1	40AF	09F6	Selects the HDMI source 1
6	COMP	40AF	0AF5	Not used
7	DVI2/AV	40AF	0BF4	Not used
8	HDMI 2	40AF	0CF3	Selects the HDMI source 2
9	P-position	40AF	1AE5	Not used
10	DisplayPort	40AF	15EA	Selects the DisplayPort source
11	SDI 1	40AF	10EF	Not used
12	PIP	40AF	11EE	Not used
13	IPC/S-V	40AF	0DF2	Selects the OPS source
14	SDI 2	40AF	16E9	Not used
15	SWAP	40AF	06F9	Not used
16	P-SOURCE	40AF	13EC	Not used
17		40AF	02FD	Navigates up through submenus and settings
18		40AF	01FE	Navigates back through submenus and settings
19	MENU	40AF	0EF1	Opens the display's on-screen menu system. When the menu system is already open, pressing this button will select the previous submenu.
20		40AF	03FC	Navigates forward through submenus and settings

Num	Function	Customer Code	Hex Code	Description
21	▼	40AF	19E6	Navigates down through submenus and settings
22	ENTER	40AF	12ED	Selects highlighted menu choices
23	EXIT	40AF	05FA	Closes the menu system
26	SCALING	40AF	14EB	Toggles between different aspect ratios (Auto, Native, 4 x 3, 16 x 9, 16 x 10 and Letterbox)
27	FREEZE	40AF	43BC	Freezes the current source image
28	MUTE	40AF	00FF	Turns off the sound
29	BRIGHT	40AF	17E8	Adjusts the brightness
30	CONTRAST	40AF	18E7	Adjusts the contrast
31	AUTO	40AF	1EE1	Synchronizes the display to the source
32	SOURCE	40AF	0FF0	Allows selection of the different sources
33	VOLUME -	40AF	1BE4	Decreases the sound volume
34	VOLUME +	40AF	1DE2	Increases the sound volume

Locking/Unlocking the OSD Menus

You can lock or unlock the OSD menus by pressing a series of key commands on the remote control. To **lock** the menu, press the following keys on the remote in the order listed: ENTER, ENTER, EXIT, EXIT, ENTER and EXIT. To **unlock** it, simply follow the same sequence.

Depending on whether you locked or unlocked the menu, you will see one of the following messages on the screen.

Key Unlocked

Key Locked

Changing the Remote Control Battery

- 1 Remove the battery cover.**
Slide back and remove the battery cover in the direction of the arrow.

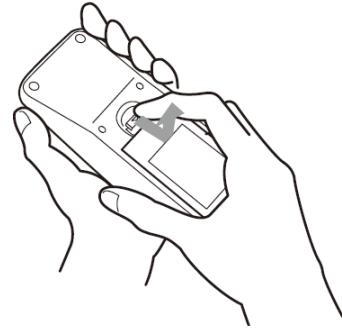

- 2 Insert the batteries.**
Align and insert two AAA batteries according to their plus and minus ports (as indicated in the remote control).

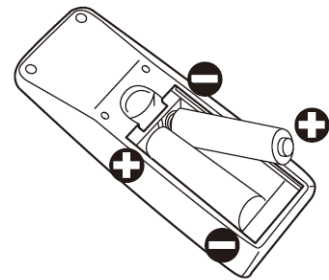

- 3 Close the battery cover.**
Replace the battery cover in the direction of the arrow and snap it back into place.

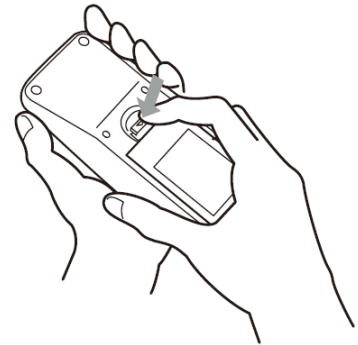

Turning the Display On

- 1** Insert the power cord into the display and into the power outlet.
- 2** Ensure the AC switch is set to “—”.
- 3** Press the power button on the remote or side control panel.

Turning the Display Off

With the power on, press the power button on the remote or side control panel to put the LCD panel in a standby mode. To turn off power completely, turn the AC switch to "O" or disconnect the AC power cord from the power outlet.

Note: If there is no signal for a certain period of time, the LCD panel will automatically go into standby mode.

Adjusting the Volume

- 1 Using the remote, press the VOLUME - or VOLUME + to increase or decrease the volume.
- 2 Press the MUTE button to temporarily turn off all sound. To restore the sound, press the MUTE button again.

Selecting the Input Source

- 1 Do one of the following:
 - Using the remote, press the desired source button (VGA, HDMI 1, HDMI 2, DVI, DISPLAYPORT, OPS).
 - Press the source button on the display's keypad. Use the arrow buttons (▲, ▼, ◀, ▶) to select one of the following input sources and press ENTER: VGA, HDMI 1, HDMI 2, DVI, DISPLAYPORT, OR OPS.

Standard Inputs

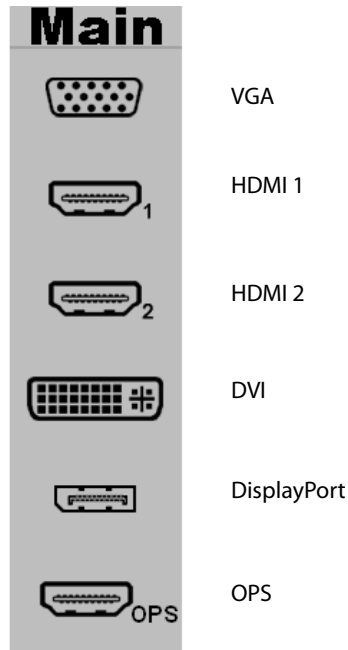

Note: When the display cannot find a source, a “No signal” message will appear.

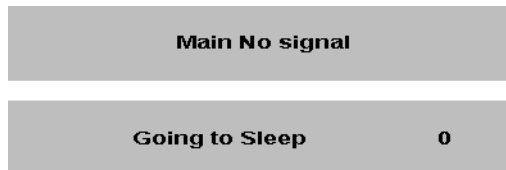

OSD Menu Functions

Depending on the source, the monitor operates in one of three modes: Graphics, Video, and 3840x2160:

- Graphics mode is automatically selected for graphic sources such as a PC. For these sources, some adjustments (such as hue and tint) are not available because they degrade the image quality.
- Video mode is automatically selected for video sources such as a DVD or Blu-Ray player. For these sources, hue and tint may need to be adjusted for optimum results.
- 3840x2160 mode is automatically selected when the resolution of the incoming signal is 3840x2160. For these signals, some adjustments are not available, and the display is automatically adjusted to the optimum brightness and contrast to maximize the performance of the LCD at high resolution. To adjust the brightness of the display in 3840x2160, use the backlight adjustment to make the display brighter or dimmer to account for ambient light conditions.

Main Menu	Submenu	Secondary Menu	Description	Setting	Mode		
					Video	Graphics	3840x2160
Image Settings	Scheme		In Video mode, select the scheme	User, Vivid, Cinema, Game, Sport	O		
	Brightness		Adjust the brightness of the screen	0~100	O	O	
	Contrast		Adjust the contrast of the screen	0~100	O	O	
	Sharpness		Adjust the sharpness of the screen	0~24	O	O	
	Saturation		Adjust the saturation of the screen	0~100	O		
	Hue		Adjust the hue of the screen	0~100	O		
	Backlight		Adjust the backlight	0~100	O	O	O

Main Menu	Submenu	Secondary Menu	Description	Setting	Mode		
					Video	Graphics	3840x2160
Image Settings	Color Temp & Gamma	Gamma	Select the Gamma	1.85, 1.9, 1.95, 2.0, 2.05, 2.1, 2.15, 2.2, 2.25, 2.3, 2.35, 2.4, 2.45, 2.5, 2.55, 2.6, Off	O	O	
		Color Temp	Select the Color Temp	3200K, 5000K, 6500K, 7500K, 9300K, User	O	O	
		Red Gain	Select the Red Gain	128~383	O	O	
		Green Gain	Select the Green Gain	128~383	O	O	
		Blue Gain	Select the Blue Gain	128~383	O	O	
		Red Offset	Select the Red Offset	-50~50	O	O	
		Green Offset	Select the Green Offset	-50~50	O	O	
		Blue Offset	Select the Blue Offset	-50~50	O	O	
		Flesh Tone	Select the Flesh Tone setting	Off, Low, Medium, High	O		
		Noise Reduction	Select the Noise Reduction setting	Off, Low, Medium, High	O		
		Local Dimming	Select the Local Dimming setting	Off, On	O	O	O
		MEMC	Select the MEMC setting	Off, Low, Medium, High	O	O	O

Main Menu	Submenu	Secondary Menu	Description	Setting	Mode		
Display Settings	Main	Aspect Ratio	Adjust the aspect ratio of the screen	Full screen, 4:3, Letterbox, Native	○	○	
		Zoom	Adjust the zoom function	▶ ◀	○	○	
		Auto Scan	Select the Auto scan function	Off, On	○	○	○
		Select Source	Select the main input source	VGA, HDMI 1, HDMI 2, DVI, DisplayPort, OPS	○	○	○
Audio Settings	Volume		Adjust the volume	0~100	○	○	○
	Bass		Adjust the Bass volume	-6~+6	○	○	○
	Treble		Adjust the Treble volume	-6~+6	○	○	○
	Balance		Adjust the balance of the screen	-6~+6	○	○	○
	HDMI Audio Input		Audio input control	HDMI/PC	○	○	○
	DP Audio Input		Audio input control	DisplayPort/PC	○	○	○
	Internal Speakers		Disable internal audio speakers	On, Off	○	○	○

Main Menu	Submenu	Secondary Menu	Description	Setting	Mode		
					Video	Graphics	3840x 2160
Basic Settings	OSD Transparency		Adjust the OSD transparency function	0~100	O	O	O
	OSD Location		Adjust the OSD location	▶,◀,▲,▼	O	O	O
	OSD Zoom		Adjust the OSD size (Disable in portrait type)	Off, On	O	O	O
	OSD Rotation		Adjust the OSD rotation	Landscape/ Portrait	O	O	O
	OSD Language		Select the OSD language	English/ Chinese	O	O	O
	OSD Timeout		Select the OSD timeout seconds	5~120 sec.	O	O	O
	Sleep Timer		Select the sleep timer	Off, 15, 30, 60, 90, 120 Min.	O	O	O
	Power LED		LED on rear of display shows powered on/off or standby mode	Off, On	O	O	O
	Splash Screen		Set the Splash Screen function	Off, On	O	O	O
	Real Time Clock (RTC)	Current Mode	Set up Date & Time	Year, Month, Day, Hour:Minutes, Weekdays	O	O	O
Timer Mode		Set up schedule	User, Same Settings on All, Same Settings on Work Days	O	O	O	

Main Menu	Submenu	Secondary Menu	Description	Setting	Mode		
					Video	Graphics	3840x 2160
Advanced Settings	Auto Adjustment		Select the Auto Adjustment Function for VGA input	Off, On		O	
	Image Position		Adjust the image position for VGA input	▶◀▲▼		O	
	Phase		0~63	According to resolution		O	
	Clock		0~100	According to resolution		O	
	VGA ADC Settings	ADC Mode	Select ADC mode	Default, User		O	
		User ADC Calibration	Perform an ADC calibration	Yes, No		O	
		Restore ADC to Default	Reset the default ADC settings	Yes, No		O	
	IRFM		Select the anti burn-in mode function	Off, On	O	O	O
	Baud rate		Setting the baud rate of the display	115200, 38400, 19200, 9600	O	O	O
	Smart light control		Select the Backlight control function DCR (Dynamic contrast) – from the input source Light Sensor – from ambient light	Off, DCR, Light Sensor	O	O	O
Wake Up From Sleep		Energy-saving function	VGA Only / VGA, Digital, RS232 / Never Sleep	O	O	O	

Main Menu	Submenu	Secondary Menu	Description	Setting	Mode		
					Video	Graphics	3840x 2160
Advanced Settings	Ethernet Setup	Enable Network	Enable the network feature	Yes, No	O	O	O
		Dynamic IP	Enable the Dynamic IP mode	Disable, Enable	O	O	O
		Static IP Address	Set the static IP address	255.255.255.255 (0.0.0.0)	O	O	O
		Subnet Mask	Set the subnet mask	255.255.255.255 (0.0.0.0)	O	O	O
		Gateway	Set the gateway address	255.255.255.255 (0.0.0.0)	O	O	O
		DNS Address	Set the DNS address	255.255.255.255 (0.0.0.0)	O	O	O
		Save Network Settings	Update the IP settings to the net device	Yes, No	O	O	O
		Email Alert	Configure email alert settings		O	O	O
		Load Default Settings	Load the default network settings	Yes, No	O	O	O
		Refresh	Refresh the network info.		O	O	O
		Device MAC	Show the unique address assigned to network interfaces		O	O	O

Main Menu	Submenu	Secondary Menu	Description	Setting	Mode		
					Video	Graphics	3840x2160
Advanced Settings	Multi-Display Control	Monitor ID	Manually select the Monitor ID of each display	1~25	O	O	O
		Video Wall	Disable/Enable Video Wall	Yes, No	O	O	O
		Power On Delay	Select the Power On delay in seconds for each display in the video wall	0~30 Sec. (in 0.05 second increments)	O	O	O
		Frame	Disable/Enable Frame compensation	Yes, No	O	O	O
		Matrix X	Sets the number of displays used in the horizontal position	1~5	O	O	O
		Matrix Y	Sets the number of displays used in the vertical position	1~5	O	O	O
		Division X	Select the Division X	1~Matrix X	O	O	O
		Division Y	Select the Division Y	1~Matrix Y	O	O	O
	EDID Setup	DVI	Select the DVI EDID	DVI Only, Same as HDMI	O	O	O
		HDMI	Select the HDMI and OPS EDID	4Kx2K, 1080p	O	O	O
		DisplayPort	Select the DisplayPort EDID	4Kx2K, 1080p	O	O	O
	Touch Control		Select the Touch Control source	Auto, OPS, External	O	O	O
	DisplayPort Mode		Select the DisplayPort version	DP1.1, DP1.2	O	O	O
	Factory Reset		Reset to the factory default setting	Yes, No	O	O	O

Main Menu	Submenu	Secondary Menu	Description	Setting	Mode		
					Video	Graphics	3840x 2160
System Status	Channel Information	Source	Show the name of the input source		<input type="radio"/>	<input type="radio"/>	<input type="radio"/>
		Resolution	Show the current resolution		<input type="radio"/>	<input type="radio"/>	<input type="radio"/>
		Serial Number	Show serial number of the monitor		<input type="radio"/>	<input type="radio"/>	<input type="radio"/>
		Firmware Version	Show the firmware of the LCD		<input type="radio"/>	<input type="radio"/>	<input type="radio"/>

OSD Menus

Image Settings

Image Settings **PLANAR**

	Scheme	User	◆
	Brightness	<input type="text" value="50"/>	50
	Contrast	<input type="text" value="50"/>	50
	Sharpness	<input type="text" value="12"/>	12
	Saturation	<input type="text" value="50"/>	50
	Hue	<input type="text" value="50"/>	50
	Backlight	<input type="text" value="80"/>	80
	Color Temperature & Gamma ▶		
	Flesh Tone	Off	◆
	Noise Reduction	Off	◆
	Local Dimming	On	◆
	MEMC	Low	◆

Image Settings **PLANAR**

	Gamma	2.2	◆
	Color Temperature	9300K	◆
	Red Gain	<input type="text" value="256"/>	256
	Green Gain	<input type="text" value="256"/>	256
	Blue Gain	<input type="text" value="256"/>	256
	Red Offset	<input type="text" value="0"/>	0
	Green Offset	<input type="text" value="0"/>	0
	Blue Offset	<input type="text" value="0"/>	0

Display Settings

Display Settings **PLANAR**

	Aspect Ratio	Full Screen	◆
	Zoom	<input type="text"/>	◆
	Auto Scan	Off	◆
	Select source	▶	

Audio Settings

Audio Settings
PLANAR

	Volume	<input type="range" value="50"/>	50
	Bass	<input type="range" value="0"/>	0
	Treble	<input type="range" value="0"/>	0
	Balance	<input type="range" value="0"/>	0
	HDMI Audio Input	HDMI	↕
	DP Audio Input	DisplayPort	↕
	Internal Speakers	On	↕

Basic Settings

Basic Settings
PLANAR

	OSD Transparency	<input type="range" value="0"/>	0
	OSD Location	↕	
	OSD Zoom	Off	↕
	OSD Rotation	Landscape	↕
	OSD Language	English	↕
	OSD Timeout	30 Sec.	↕
	Power LED	On	↕
	Real Time Clock	▶	
	Splash Screen	On	↕

Basic Settings
PLANAR

	Current Time	2014 / 6 / 25 16 : 00 WED		
	Timer Mode	User		
	Week	Enable	Power On	Power Off
	MON	<input type="checkbox"/>	00 : 00	00 : 00
	TUE	<input type="checkbox"/>	00 : 00	00 : 00
	WED	<input type="checkbox"/>	00 : 00	00 : 00
	THU	<input type="checkbox"/>	00 : 00	00 : 00
	FRI	<input type="checkbox"/>	00 : 00	00 : 00
	SAT	<input type="checkbox"/>	00 : 00	00 : 00
	SUN	<input type="checkbox"/>	00 : 00	00 : 00

RTC Submenus

RTC

Timer Mode	User	Week	Enable	Power On	Power Off
		MON	<input type="checkbox"/>	00 : 00	00 : 00
		TUE	<input type="checkbox"/>	00 : 00	00 : 00
		WED	<input type="checkbox"/>	00 : 00	00 : 00
		THU	<input type="checkbox"/>	00 : 00	00 : 00
		FRI	<input type="checkbox"/>	00 : 00	00 : 00
		SAT	<input type="checkbox"/>	00 : 00	00 : 00
		SUN	<input type="checkbox"/>	00 : 00	00 : 00

User Mode

RTC

Timer Mode	Same Settings On Work Days	Week	Enable	Power On	Power Off
		MON~FRI	<input type="checkbox"/>	00 : 00	00 : 00
		SAT	<input type="checkbox"/>	00 : 00	00 : 00
		SUN	<input type="checkbox"/>	00 : 00	00 : 00

Same Settings On Work Days Mode







RTC

Timer Mode	Same Settings On All	Week	Enable	Power On	Power Off
		MON~SUN	<input type="checkbox"/>	00 : 00	00 : 00

Same Settings On All Mode







Advanced Settings

Advanced Settings

	Auto Adjustment	No	
	Image Position		
	Phase	<input type="text"/>	
	Clocks	<input type="text"/>	
	VGA ADC Settings		
	IRFM	Off	◆
	Baud Rate	19200	◆
	Smart Light Control	Off	◆
	Wake Up From Sleep	VGA, Digital, RS232	◆
	Ethernet Setup	▶	
	Multi-Display Control	▶	
	EDID Setup	▶	
	Touch Control	Auto	◆
	DisplayPort Mode	DP 1.1	◆
	Factory Reset	No	◆

Network Settings

Advanced Settings

	Enable Network	Yes	◆
	Dynamic IP	Disable	◆
	Static IP Address	192 . 168 . 2 . 1	
	Subnet Mask	255 . 255 . 255 . 0	
	Gateway	192 . 168 . 2 . 1	
	DNS Addr.	192 . 168 . 2 . 1	
	Save Network Settings	▶	
	Email Alert	▶	
	Load Default Settings	▶	
	Refresh	▶	
	Device MAC	00:00:00:00:00:00	

Multi-Display Control

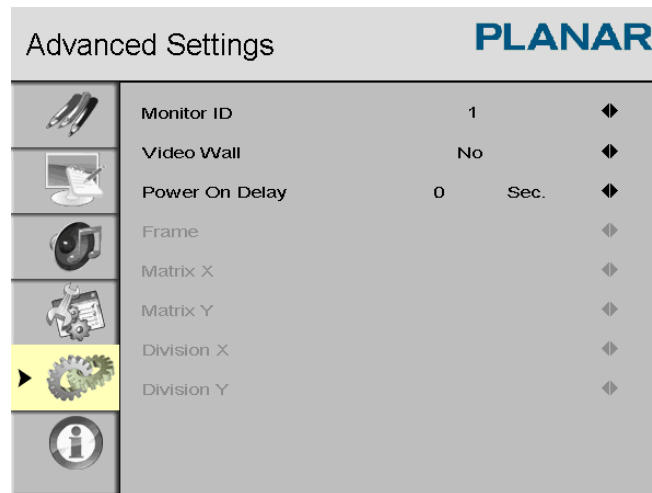

System Status

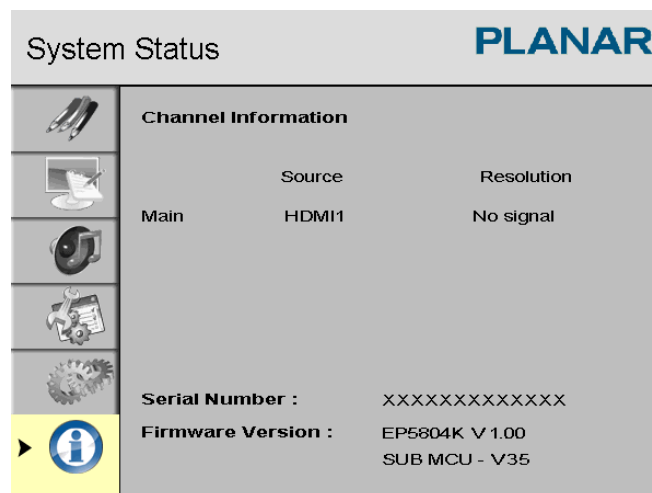

Navigating Through the Menus

- 1 With the power on, press MENU. The IMAGE SETTINGS menu appears.
- 2 Within the menu, use ▲, ▼, ◀, ▶ and ENTER to navigate through the menus and adjust options.
- 3 Press MENU to return to the previous menu. To exit the menu system, press EXIT.

Image Settings Menu

This menu is used for making common image adjustments.

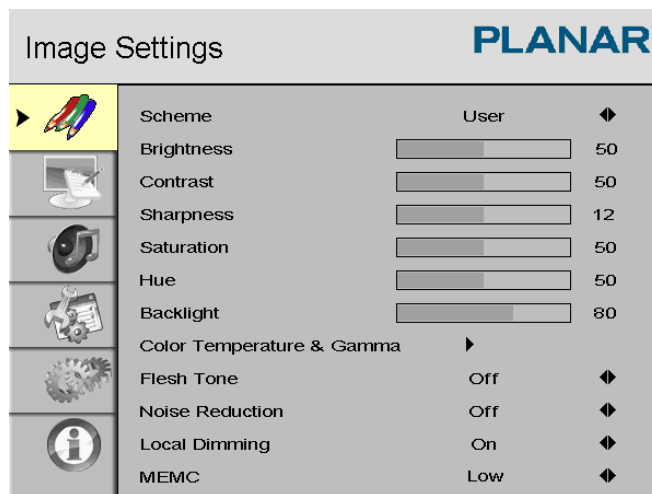

Scheme	
	Press ◀ or ▶ to select one of the following: Options: User, Vivid, Cinema, Game, Sport
Brightness	
	Increases or decreases the brightness of the picture. Press ◀ or ▶, select the desired level, and press ENTER. Range: 0~100
Contrast	
	Increases or decreases the contrast of the picture. Press ◀ or ▶, select the desired level, and press ENTER. Range: 0~100
Sharpness	
	Adjusts the definition of the picture. Press ◀ or ▶, select the desired level, and press ENTER. Range: 0~24
Saturation	
	Adjusts the brilliance and brightness (Disabled in Graphics Mode). Press ◀ or ▶, select the desired level, and press ENTER. Range: 0~100
Hue	
	Increases or decreases the green hue (Disabled in Graphics Mode). Press ◀ or ▶, select the desired level, and press ENTER. Range: 0~100

Backlight	Range: 0~100
Color Temp and Gamma	Adjusts red, green, blue gain and red, green blue offset.
Gamma	Options: Off, 1.85, 1.9, 1.95, 2.0, 2.05, 2.1, 2.15, 2.2, 2.25, 2.3, 2.35, 2.4, 2.45, 2.5, 2.55, 2.6
Color Temp	Options: User, 3200K, 5000K, 6500K, 7500K and 9300K.
Red Gain	Range: 128~383
Green Gain	Range: 128~383
Blue Gain	Range: 128~383
Red Offset	Range: -50~50
Green Offset	Range: -50~50
Blue Offset	Range: -50~50
Flesh Tone	Select the Flesh Tone setting (Disabled in Graphics Mode). Press ◀ or ▶, select the desired level, and press ENTER. Range: Off, Low, Medium, High
Noise Reduction	Select the Noise Reduction setting (Disabled in Graphics Mode). Press ◀ or ▶, select the desired level, and press ENTER. Range: Off, Low, Medium, High

Local Dimming	Local Dimming can increase the LCD performance by dimming areas that should be dark, increasing the contrast and clarity of the image. Range: Off, On
MEMC	MEMC (Motion Estimation/Motion Compensation) is a function designed to minimize display motion blur. Press ◀ or ▶, select the desired level, and press ENTER. Range: Off, Low, Medium, High

Display Settings Menu

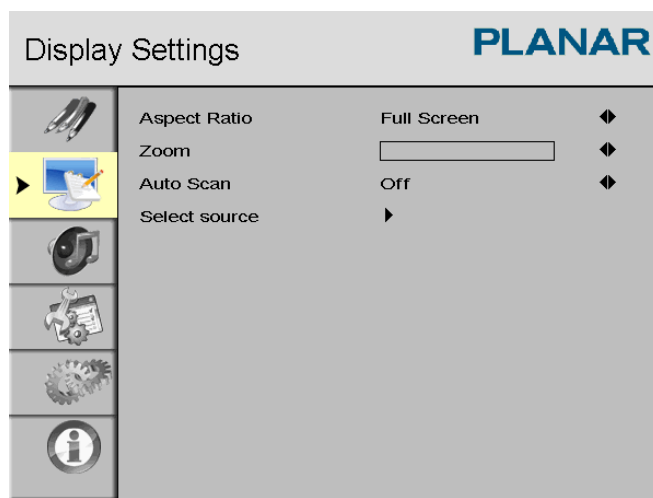

Main	Display Setting Mode
Aspect Ratio	Changes the picture's aspect ratio Press ◀ or ▶ to select the following options: Options: Full screen, Letterbox, 4:3, Native
Zoom	Range: 0~10
Auto Scan	Range: On, Off
Select Source	Options: VGA, HDMI 1, HDMI 2, DVI, DisplayPort, OPS

Audio Settings Menu

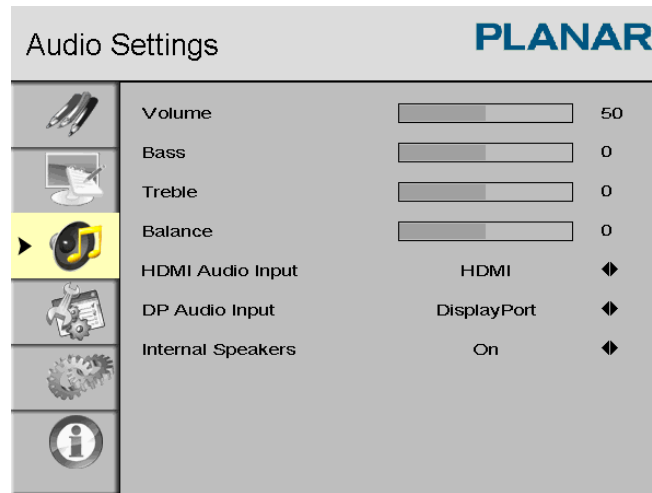

Volume	Adjust the sound. Press ◀ or ▶, select the desired level, and press ENTER. Range: 0~100
Bass	Adjust the low tones (bass). Press ◀ or ▶, select the desired level, and press ENTER. Range: -6~6
Treble	Adjust the high tones (treble). Press ◀ or ▶, select the desired level, and press ENTER. Range: -6~6
Balance	Adjust the balance of the left and right speakers. Press ◀ or ▶, select the desired level, and press ENTER. Range: -6~6
HDMI Audio Input	Select HDMI or PC audio input mode.
DP Audio Input	Select DisplayPort or PC audio input mode.
Internal Speakers	Disable or enable internal audio speakers.

Basic Settings Menu

This menu is used to make initial setup adjustments to the OSD (On-Screen Display) menu and other on-screen messages.

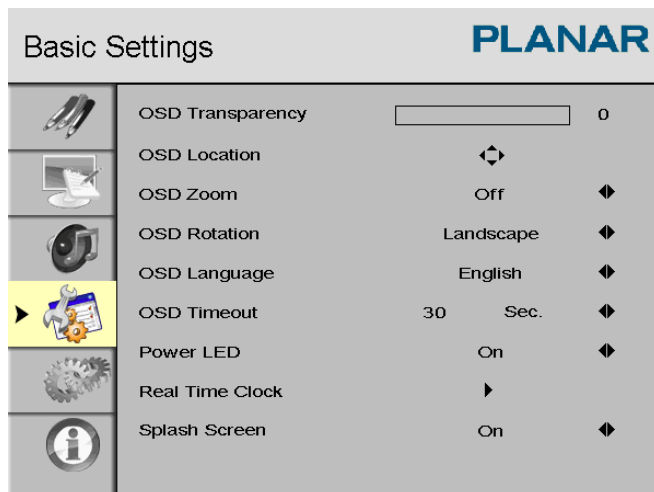

OSD Transparency	
	Set the OSD transparency function. Press ◀ or ▶ to select the desired level, and press ENTER. Range: 0~15
OSD Location	
	Adjust the menu location on the display (▲, ▼, ◀, ▶).
OSD Zoom	
	Options: On, Off
OSD Rotation	
	Select the OSD Rotation. Press ◀ or ▶ to select the rotation. Options: Landscape or Portrait
OSD Language	
	Options: English and Chinese
OSD Timeout	
	Options: 5~120
Power LED	
	LED on rear of display shows powered on/off or standby mode. Options: On, Off

Power LED	LED on rear of display shows powered on/off or standby mode. Options: On, Off
Real Time Clock	Set the date, and switch the alarm on and off. Use ▲, ▼, ◀, ▶ to adjust these options.
Splash Screen	Selects whether a Splash Screen appears when the display is powered on.

Basic Menu/RTC (Real Time Clock) Menu

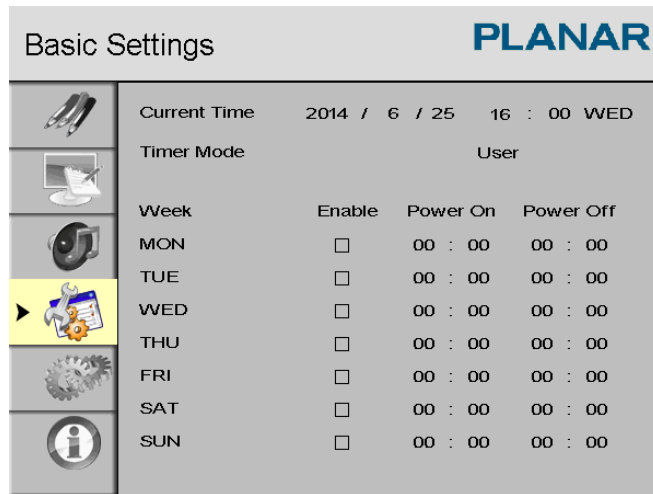

Real Time	
	Configure current time setting Year/Month/Day, Hour: Minutes, Weekday
Timer Mode	
	Configure power on/off timers User, Same Settings On All, Same Settings On Work Days

RTC Timer Mode - User

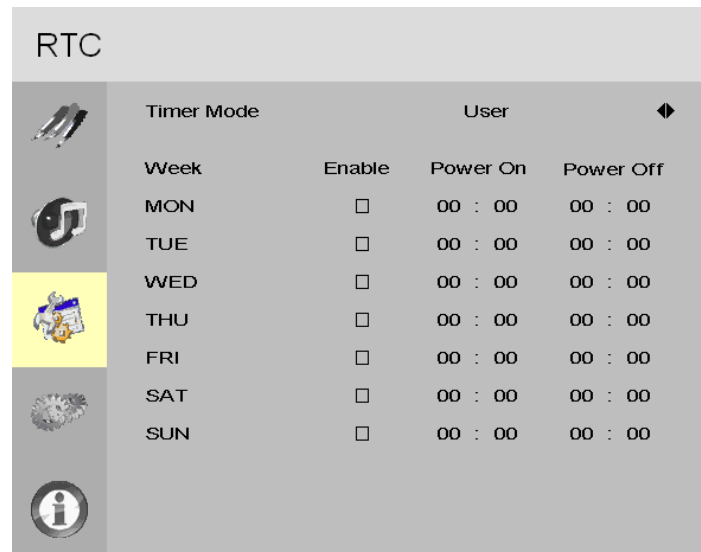

Timer Mode	
User mode	<p>Select the power on/off timer and specify the on/off times for each day of the week.</p> <p>For each day of the week, you have the following options: Enable or Disable the schedule of the day Options: Disable, Enable</p> <p>Power On/Power Off timer setup. Power On: Use the arrow keys to specify the time you want the display to turn on for the selected day. Power Off: Use the arrow keys to specify the time you want the display to turn off for the selected day.</p>

RTC Timer Mode - Work Days

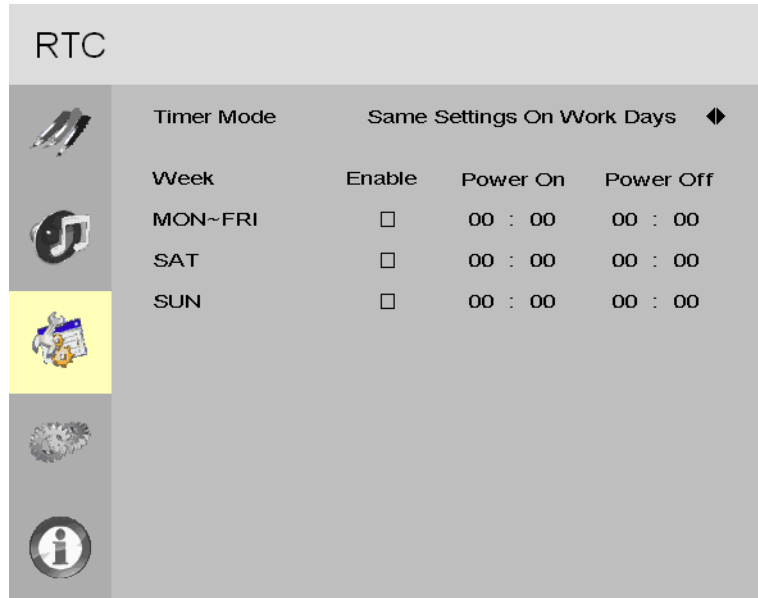

Timer Mode	
Work Days mode	<p>For Monday-Friday, Saturday or Sunday, you have the following options: Enable or Disable the schedule of the work days or individual weekend days. Options: Disable, Enable</p> <p>For all days, you have the following options: Enable or Disable the schedule for Monday-Friday, Saturday and Sunday. Options: Disable, Enable</p> <p>Power On/Power Off timer setup. Power On: Use the arrow keys to specify the time you want the display to turn on for Monday-Friday, Saturday or Sunday. Power Off: Use the arrow keys to specify the time you want the display to turn off for Monday-Friday, Saturday or Sunday.</p>

RTC Timer Mode - All Days

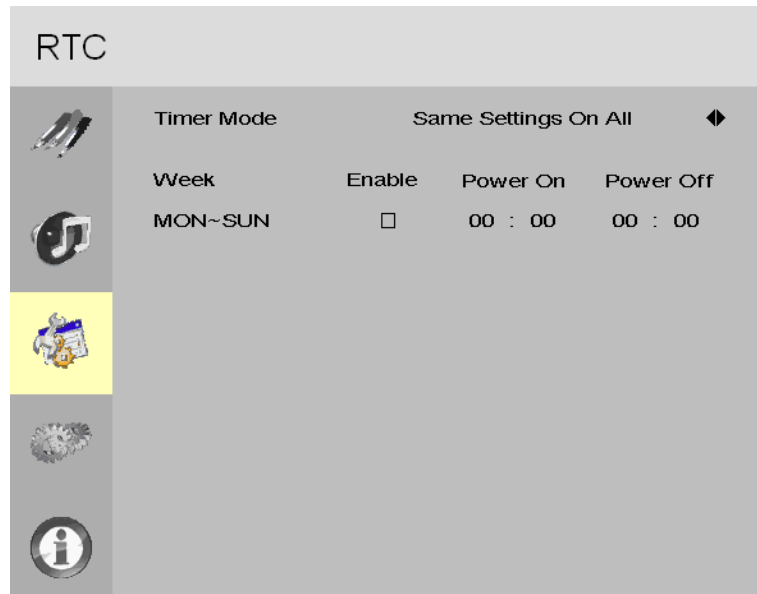
**Timer Mode****All Days** mode

Select all days of the week power on/off timer.

For all days, you have the following options:
Enable or Disable the schedule for all days of the week

Options: Disable, Enable

Power On/Power Off timer setup.

Power On: Use the arrow keys to specify the time you want the display to turn on for all days of the week.

Power Off: Use the arrow keys to specify the time you want the display to turn off for all days of the week.

Advanced Settings Menu

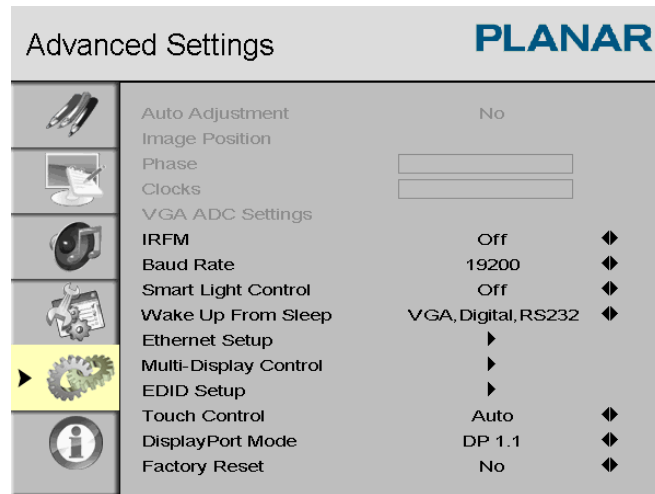











Auto Adjustment	<p>Forces the display to reacquire and lock to the input signal. This is useful when the signal quality is marginal.</p> <p>Note: This feature does not continually reacquire the signal. It only does so each time you select this option.</p> <p>Options: No, Yes</p>
Image Position	<p>Adjust the image location (VGA Mode only).</p> <p>Options: ▲, ▼, ◀, ▶</p>
Phase	<p>Adjust the phase for the VGA input.</p> <p>Range: 0~63 (VGA Mode only)</p>
Clocks	<p>Adjust the clocks for the VGA input.</p> <p>Range: 0~100 (VGA Mode only)</p>
VGA ADC Settings	<p>Select the ADC setting, User ADC Calibration, or restore factory default ADC setting.</p> <p>Options: Default, User</p>

IRFM	
	Creates slight frame motion to help avoid image retention. Options: Off, On
Baud Rate	
	Options: 115200, 38400, 19200, 9600
Smart Light Control	
	DCR (Dynamic Contrast) varies the LCD backlight automatically, depending on content, to improve black levels and contrast. Options: Off, DCR, Light Sensor
Wake Up From Sleep	
	Allows you to configure the display to “wake up” when it receives a digital signal through the DisplayPort, HDMI or DVI connectors. With VGA Only, the display can only “wake up” by sending an analog video signal through the VGA connector. Options: <u>Never Sleep</u> - The display will never enter a power saving mode. <u>VGA Only</u> - The display will enter a power saving mode if it cannot sync for five minutes with the DisplayPort, HDMI or DVI. If the sync is present, the display will “wake up” again. <u>VGA, Digital, RS232</u> - The display will enter a power saving mode if it cannot sync for five minutes with any source.
Ethernet Setup	
	Configure Network settings. See "Setting Up Email Alerts" on page 77 for more information.
Multi-Display Control	
	Used for displaying one image across multiple displays.
EDID Setup	
	Enables EDID over various formats.
Touch Control	
	Selects the touch control surface. Options: Auto, OPS, External

DisplayPort Mode	
	Selects the DisplayPort version. Options: DP1.1, DP1.2
Factory Reset	
	Reset to the factory default setting. Options: No, Yes

Advanced Settings - Ethernet Setup Submenu

Advanced Settings		PLANAR	
	Enable Network	Yes	◆
	Dynamic IP	Disable	◆
	Static IP Address	192 . 168 . 2 . 1	
	Subnet Mask	255 . 255 . 255 . 0	
	Gateway	192 . 168 . 2 . 1	
	DNS Addr.	192 . 168 . 2 . 1	
	Save Network Settings	▶	
	Email Alert	▶	
	Load Default Settings	▶	
	Refresh	▶	
	Device MAC	00:00:00:00:00:00	

Enable Network	Enable the network feature Options: No, Yes
Dynamic IP	Enable DHCP for dynamic IP address assignment. Options: Disable, Enable Note: When dynamic IP is enabled, the parameters received from the DHCP server are shown in the STATIC IP ADDRESS, SUBNET MASK, GATEWAY and DNS ADD lines.
Static IP Address	Set the static IP address when the DYNAMIC IP line is disabled or view it when the DYNAMIC IP line is enabled. Range: 255.255.255.255 (0.0.0.0)
Subnet Mask	Set the subnet mask when the DYNAMIC IP line is disabled or view it when the DYNAMIC IP line is enabled. Range: 255.255.255.255 (0.0.0.0)

Gateway	
	Set the gateway address when the DYNAMIC IP line is disabled or view it when the DYNAMIC IP line is enabled. Range: 255.255.255.255 (0.0.0.0)
DNS Address	
	Set the DNS address when the DYNAMIC IP line is disabled or view it when the DYNAMIC IP line is enabled. Range: 255.255.255.255 (0.0.0.0)
Save Network Settings	
	Save the network configuration when the DYNAMIC IP line is disabled. Options: No, Yes
Email Alert	
	Enable/disable the following email alerts: POWER STATUS ALERT - Sent when the unit is turned on or off. SOURCE STATUS ALERT - Sent when a different source is selected. SIGNAL LOST ALERT - Sent when the input sync is lost.
Load Default Settings	
	Load default network settings Options: No, Yes
Device MAC	
	Shows the unique address assigned to network interfaces.

Advanced Settings - User ADC Calibration

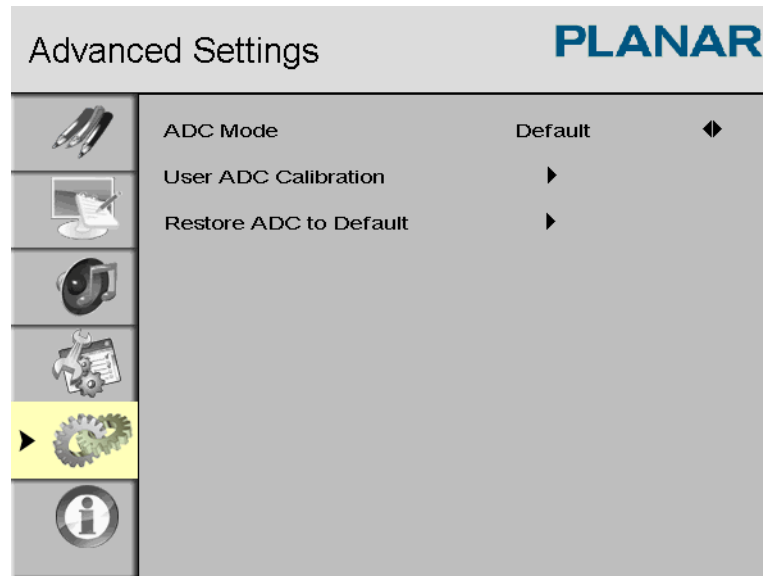

- 1 When using VGA as a signal source, go to ADVANCED SETTINGS in the OSD menu, select VGA ADC SETTINGS and then select USER ADC CALIBRATION.
- 2 A warning message (see image below) will appear to help you ensure that the correct image is displayed on screen before ADC calibration begins.
 - a The image in the green boxes, displayed on both side of the screen, has to be white and black in order to run the calibration accurately (the black and white image can be made using software like Microsoft Paint).
 - b The white in the left green box has to be the brightest white.
 - c The black in the right box has to be the darkest black.

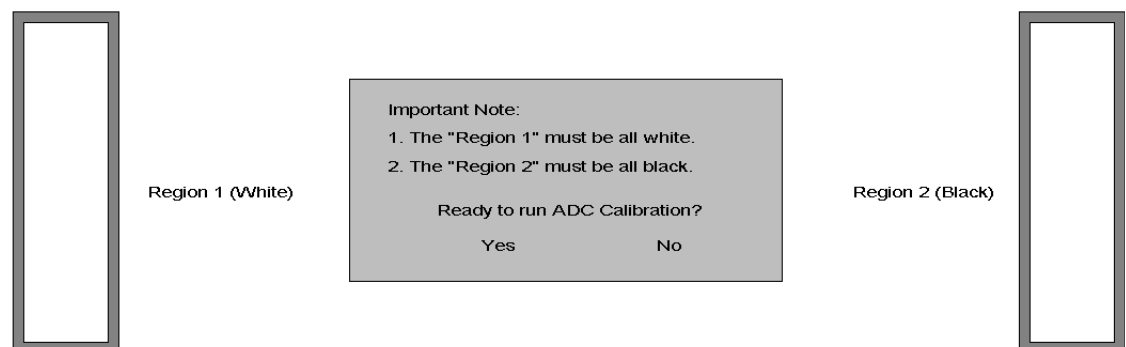

- 3 After the correct image is displayed, click "Yes" to begin ADC calibration.

- 4 During the calibration process, the following message will appear to notify you to wait for the calibration.

User ADC Calibration... Please Wait!

- 5 After the calibration is complete, you will see one of two messages.

User ADC Calibration Finish!

User ADC Calibration Failure!

Advanced Settings - Multi-Display Control Submenu

The menu is used for displaying one image across multiple displays. The software allows you to tile up to a 5 x 5 array. With a DisplayPort signal, you can loop up to nine displays. Additional displays may be added using a distribution amp. The loop through function only works with the DisplayPort inputs.

It is also important to note that the maximum cable length between displays is three meters.

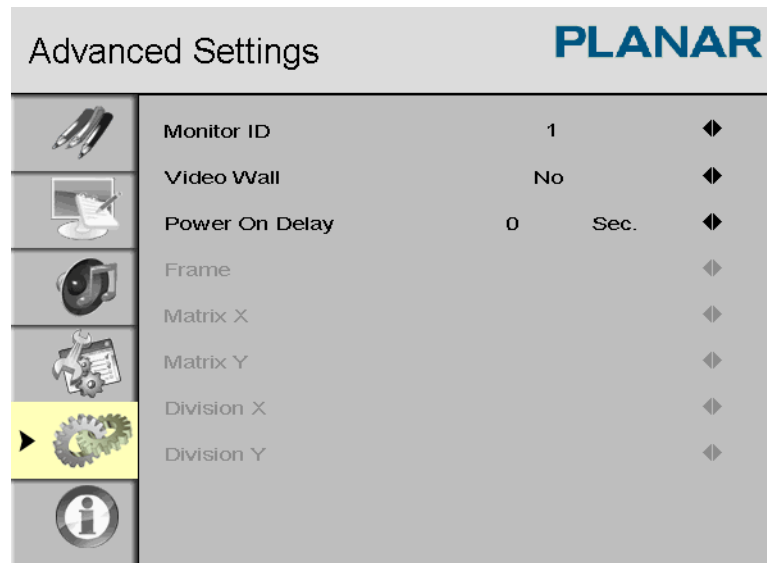

Monitor ID	<p>Used to manually set the Monitor ID of each display in the video wall.</p> <p>Options: 1-25</p>
Video Wall	<p>Used for displaying one image across multiple displays.</p> <p>Options: Yes, No</p> <p>Note: If No is selected, all of the options below the Power On Delay line will be grayed out.</p>
Power On Delay	<p>When powering on a video wall, this feature staggers the power on sequence so that all displays will not turn on at once, reducing current requirements.</p> <p>Options: 0~1.50 (in .05 second increments)</p>

Frame	
	This feature enables or disables frame compensation. Options: Yes, No
Matrix X	
	Sets the number of displays used in the horizontal position Options: 1-5
Matrix Y	
	Sets the number of displays used in the vertical position Options: 1-5
Division X	
	Sets the horizontal position of the display wall matrix Options: 1~ Matrix X
Division Y	
	Sets the vertical position of the display wall matrix Options: 1~ Matrix Y

Advanced Settings - EDID Setup

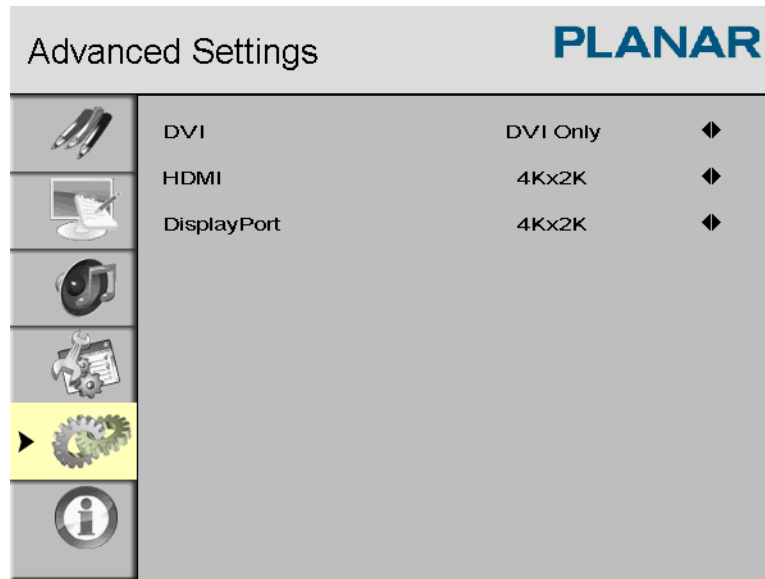

DVI	Select the DVI EDID Options: DVI Only, Same as HDMI
HDMI	Select the HDMI and OPS EDID Options: 4Kx2K, 1080P
DisplayPort	Select the DisplayPort EDID Options: 4Kx2K, 1080P

System Status Menu

This read-only menu provides information about the active sources and the latest firmware version.

Channel Information		
	Source	Resolution
Main	HDMI1	No signal

Serial Number : XXXXXXXXXXXXXXX

Firmware Version : EP5804K V 1.00
SUB MCU - V35

Using the Touch Screen

You can use the touch screen to control your operating system. The touch screen can emulate basic mouse functions and supports multi-touch functions for Windows 7* and Windows 8*. The following table shows a list of functions you can use on the touch screen.

Note: *Ensure that you have installed the USB cable on the display to a computer.

Note: If an OPS PC is installed in the OPS slot, the OPS PC will automatically be connected internally to the touch system. The touch functionality is configurable via the Touch Control setting.

Performing basic functions

The following table shows how to perform basic tasks using the touch screen for Windows 8, Windows 7, Vista, XP, Mac OSX, and Linux.

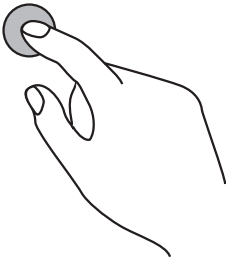
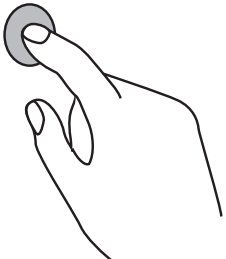
Function	Action	
Click	Tap the screen once.	
Double-Click	Tap the screen twice.	

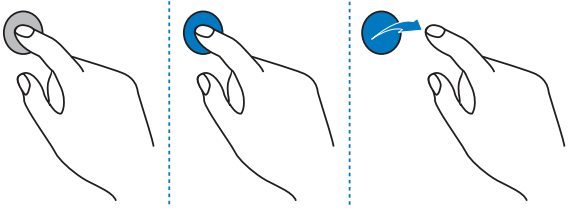
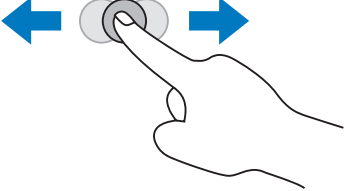
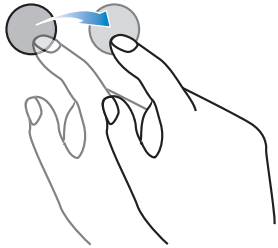
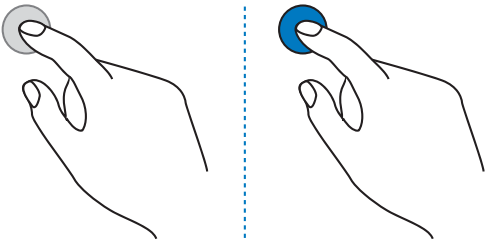
<p>Right-click</p>	<p>Press on the target. Hold and wait for a blue ring to appear. Release your finger.</p>	
<p>Drag or select</p>	<p>Drag one finger left or right.</p>	
<p>Pan up/down /back/forward</p>	<p>Quickly drag your finger (flick) in a desired direction.</p>	
<p>Wake up from Windows sleep mode (S3)</p>	<p>Press and hold for four seconds.</p>	

Touchscreen MultiTouch Driver Installation

- 1 With the PC on, plug in the USB memory stick to the USB drive.
- 2 Locate and open the USB drive.
- 3 Double-click on the “mt_driver_kit [xxxxxx].exe” to install the driver.
- 4 Follow installation prompts until driver installation is complete.

Once driver installation is complete, the touchscreen is ready for use.

Touchscreen (PQLabs) MultiTouch Platform Content

The PQLabs Software is used for troubleshooting and calibration. The different menus are described below.

- 1 On the PC, select the **Start** menu, **All Programs** and then **PQLabs Software**.
- 2 Click on “MultiTouch Platform” to open the PQLabs MultiTouch Platform window.

Touchscreen Information

- Serial Number – Displays the serial number of the connected touchscreen.
- Firmware Version – Displays the firmware version of the touchscreen selected under the “Serial Number” dropdown menu.
- Touch Points – Displays the number of touch points for which the touchscreen is capable.
- Status – Displays the current status of the touchscreen.

Calibration

- Calibration – Starts a 4-point calibration of the touchscreen. Perform the programmed touchscreen calibration process. At the conclusion of the calibration routine your touchscreen device is ready to use and will perform with accurately positioned touch points.
- Reset Calibration – Resets calibration to factory default settings.

Utility

- Diagnose – Starts the “MultiTouchDoctor” program. This can be used to troubleshoot issues with the touchscreen.

Options

- Default settings on options have the following programs enabled: Tuio Support, Flash Tuio Support, Handwriting Optimization, Enable Windows Native Touch, Enable Mouse/Keyboard Simulation, and Launch When Windows Starts Up.
- Flexible Scan Rate is at a default setting.

Uninstalling the MultiTouch Driver

- 1 On the PC, select the **Start** menu, **All Programs** and the **PQLabs Software**
- 2 Click on the MultiTouch Driver.
- 3 Select the Uninstall option.

Multi-Touch Functions

The following table shows how to perform multi-touch tasks using the touch screen for Windows 7 - Home Premium, Professional, Enterprise and Ultimate versions.

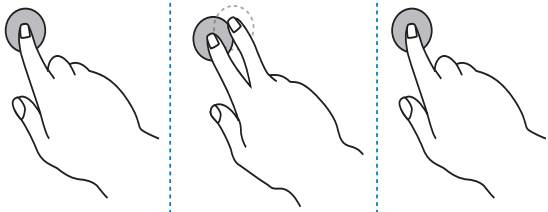
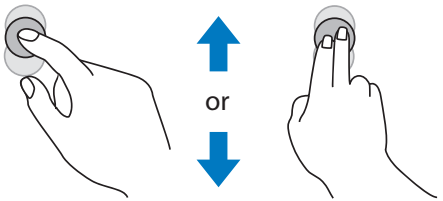
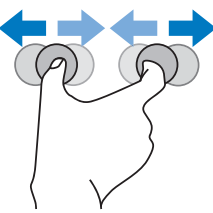
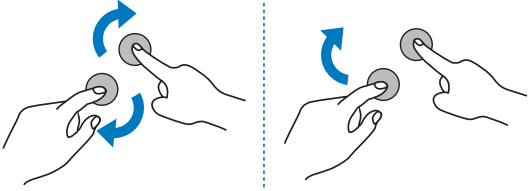
Function	Action	
Right-click	Press on the target. Tap the screen with another finger. Release the second finger.	
Scrolling	Drag one or two fingers up or down.	
Zoom	Move two fingers apart or toward each other.	
Rotate	<ul style="list-style-type: none"> • Move two fingers in opposing directions • Use one finger to pivot around the other. 	

LAN Control

The Planar EP-Series supports extending access to the RS232 commands over a network connection using a virtual COM port (VCOM). The VCOM driver installer is included on the USB drive that came with your display.

Note: RS232 commands over LAN can be achieved by opening a TCP connection to Port 23 to the display. The LAN control functionality is most frequently used by control systems, and they won't be able to use the VCOM drivers

Supported Operating Systems

The utility supports the following operating systems:

- Windows XP
- Windows Vista
- Windows 7
- Windows 8 and 8.1

Installation

Use the following instructions to install the VCOM driver.

- 1 Launch the vcomsetup.exe file.
- 2 You may see a security warning similar to the following example. Click Run to continue.

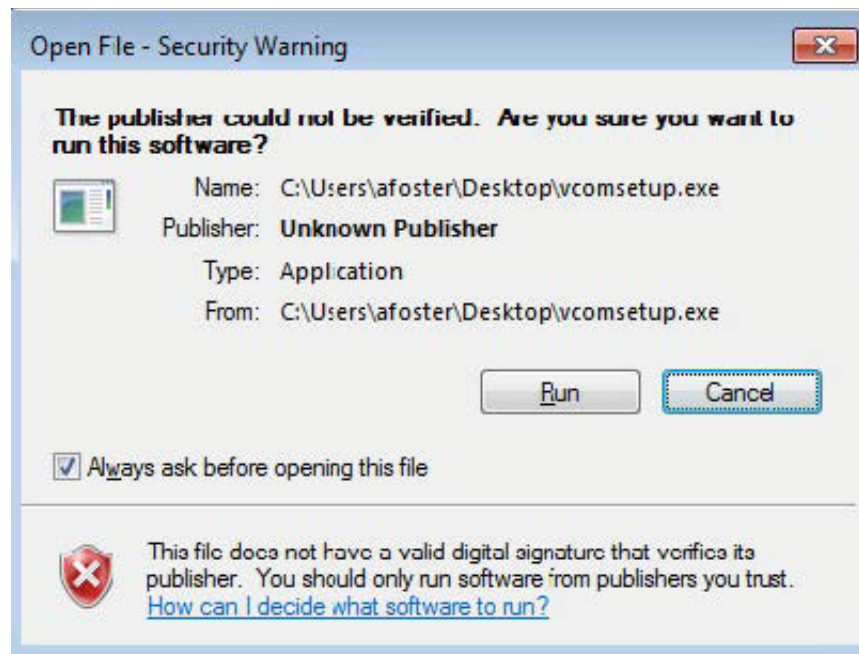

- The vcomsetup.exe installer installs both the VCOM virtual serial port and also a utility (WinPcap) for finding your EP5804K/EP6504Ks on the network. Follow the steps in the two installers, accepting defaults and license agreements as needed.

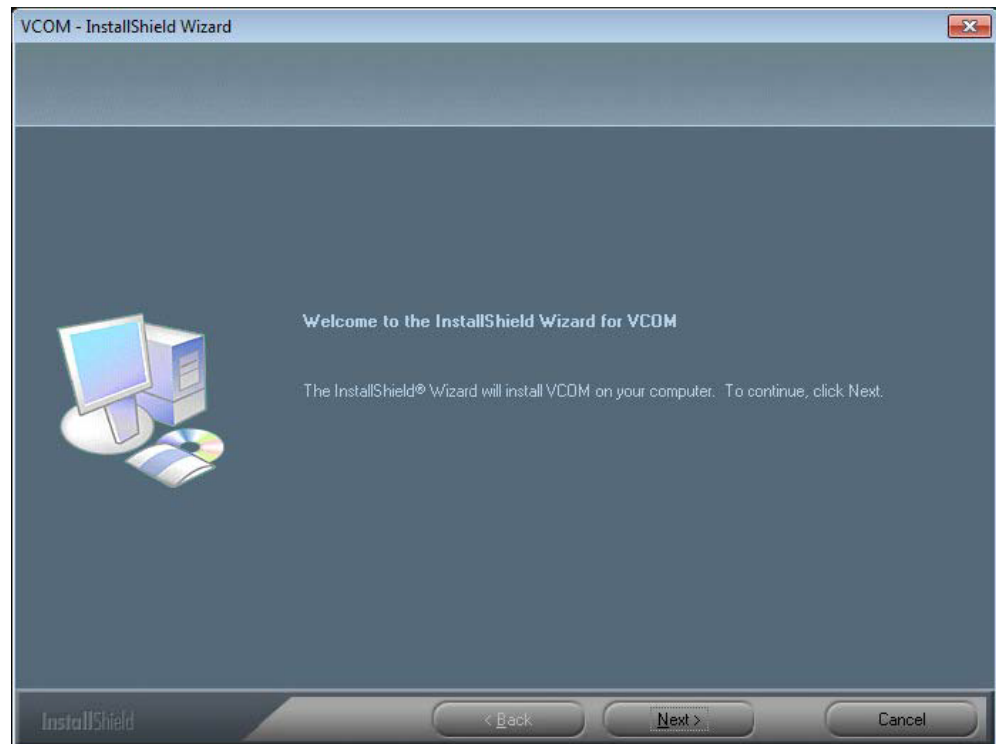
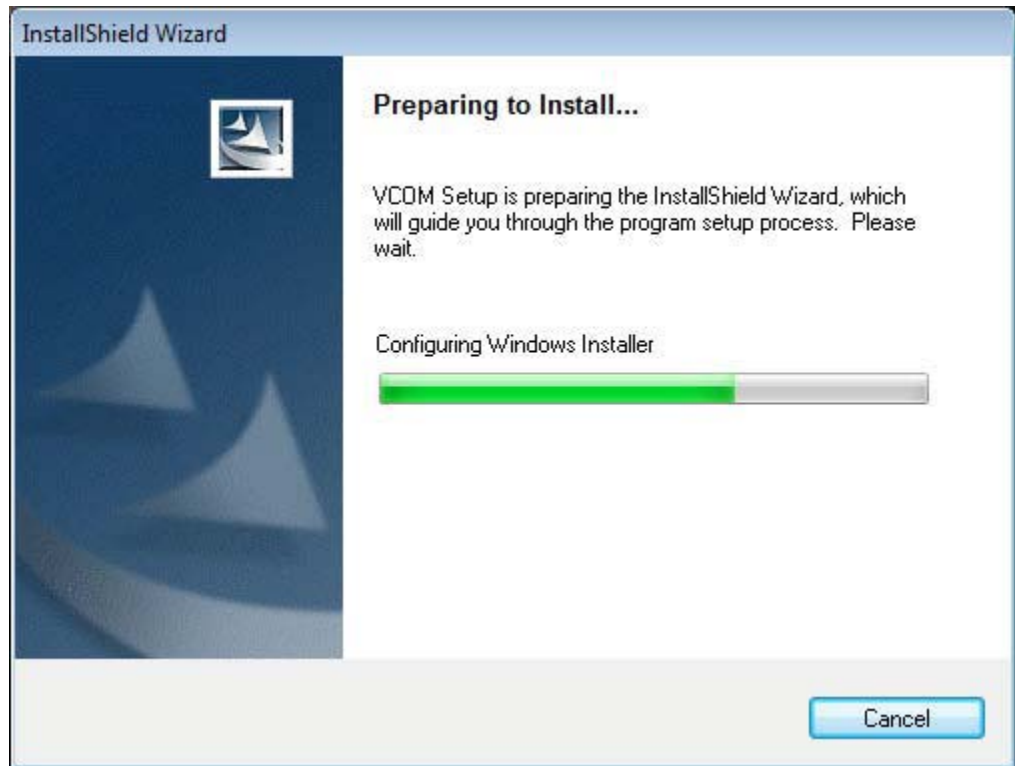



- 4 When the installers are finished, you will see a VCOM icon on your desktop and you find two new folders in your start menu: IC Plus corp (with VCOM sub folder) and WinPcap. If you need to uninstall the software, there are shortcuts to uninstall from these menus.



Configuring VCOM

Use the VCOM shortcut to launch the VCOM setup utility. The utility starts up on the Device Info page, shown below. The controls on this page allow you to find and configure each display that you want to access via virtual COM ports.

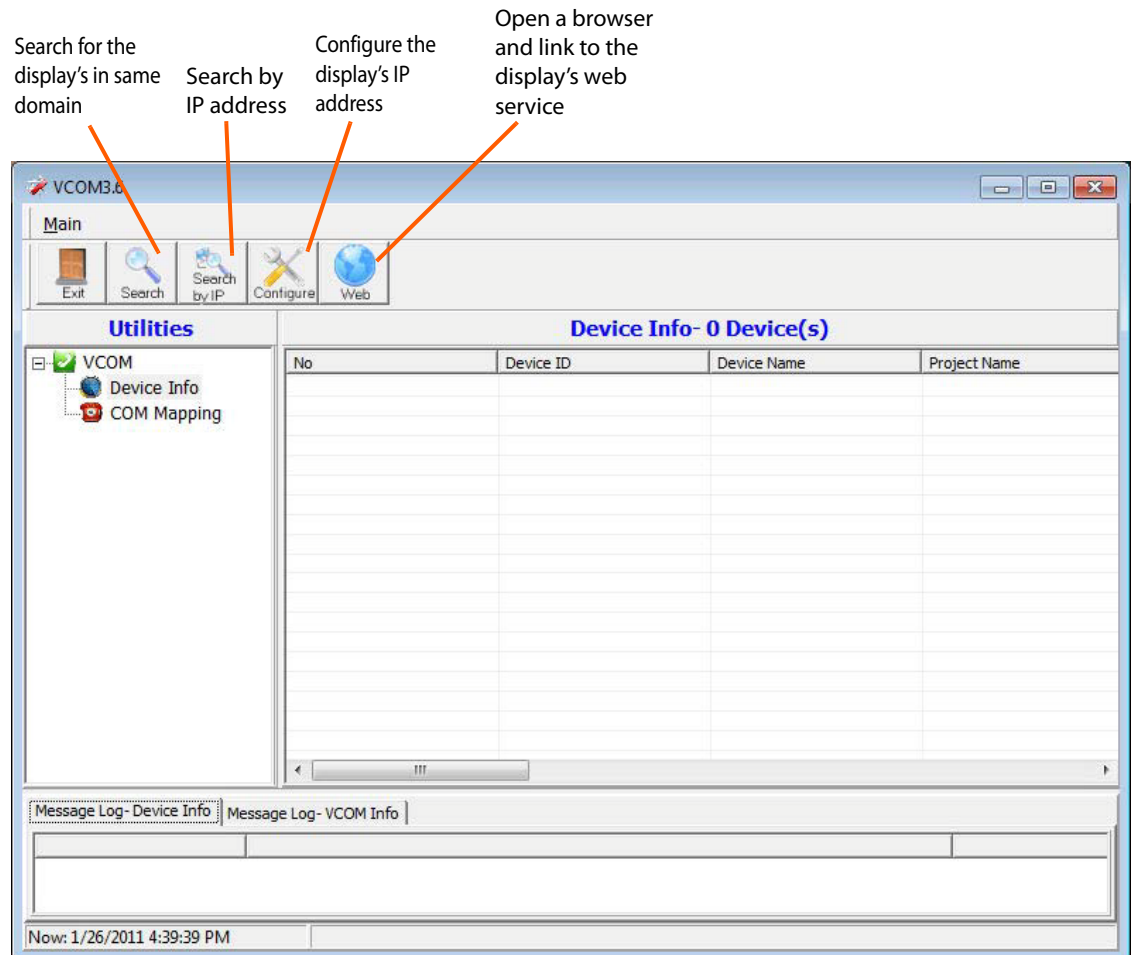

Function Descriptions

Search

In the Device Info page, click the Search icon. This function searches for any devices that are connected to the same network segment (maximum of 254 devices) as your PC. Any devices found will be listed in the Device Info table.

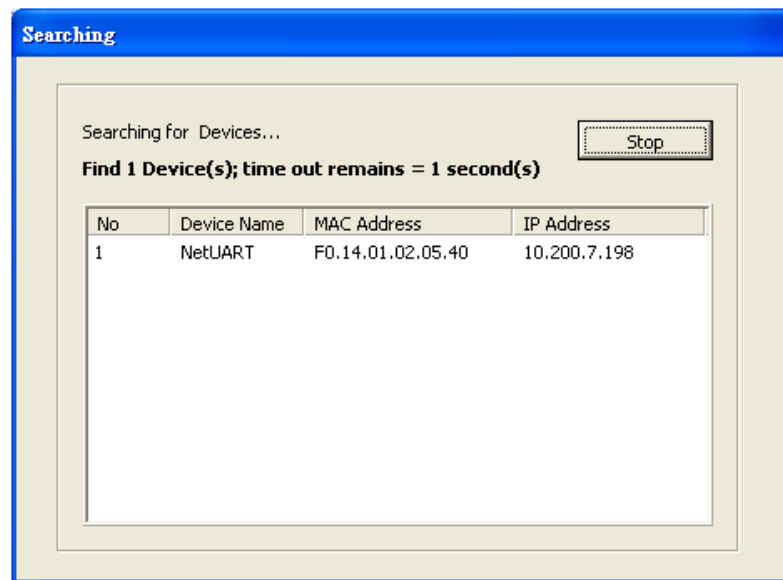

Search By IP

On the Device Info page, click the Search by IP icon. This function searches for any devices in the given IP address range. Any devices found will be listed in the Device Info table.

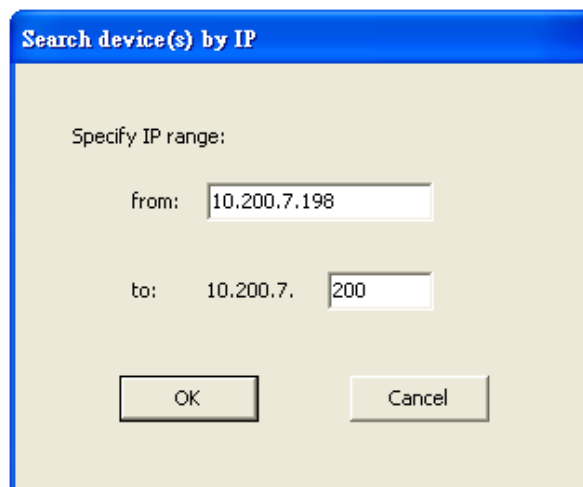

Configure IP Address

This function allows you to configure the network settings of the selected device. We recommend using the on-screen menus or the web interface described in the User Guide instead of this function.

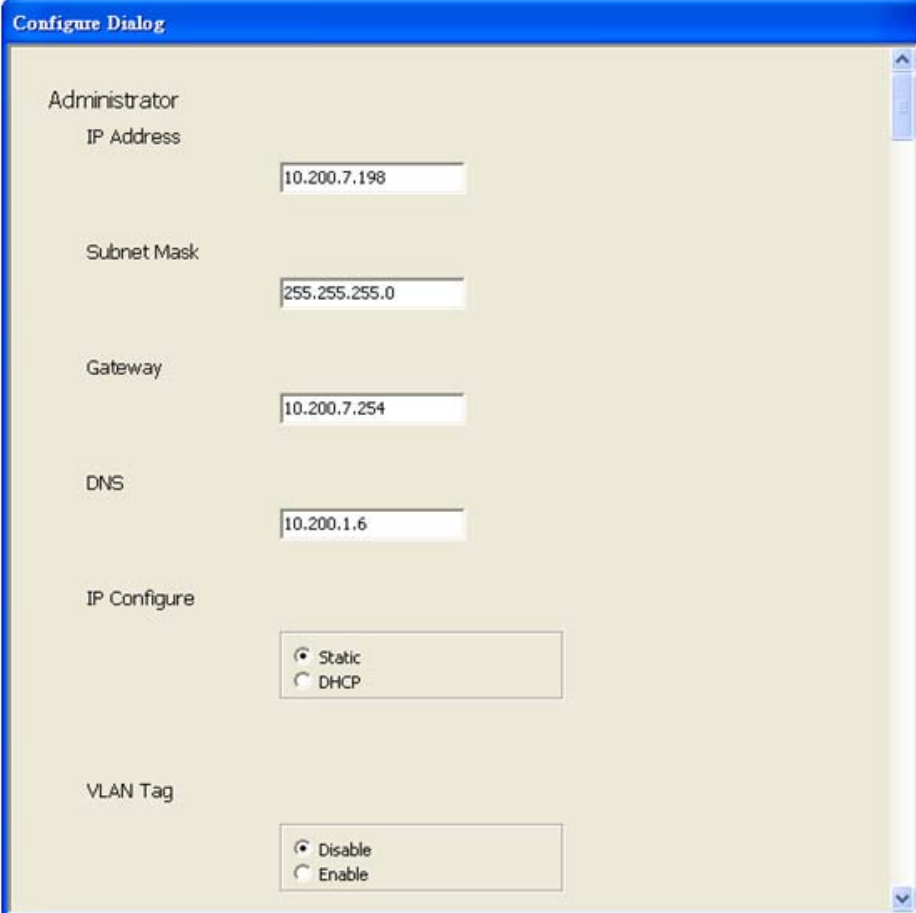

The screenshot shows a 'Configure Dialog' window with the following fields and options:

- Administrator
- IP Address: 10.200.7.198
- Subnet Mask: 255.255.255.0
- Gateway: 10.200.7.254
- DNS: 10.200.1.6
- IP Configure: Static, DHCP
- VLAN Tag: Disable, Enable

Note: To cancel this function, scroll to the bottom and click the Cancel button.

Web

Click the Web icon to launch your default browser and link it to the display's web service.

Adding a Virtual COM Port

To add a virtual COM port, click the Add icon on the COM Mapping page to open the following dialog window.

The screenshot shows the 'Add VCOM' dialog box. It features a table with the following data:

No	Device Name	MAC Address	IP Address
1	NetUART	F0.14.01.02.05.40	10.200.7.198

Below the table, the 'TCP/UDP' section has 'TCP' selected. The 'Server/Client' section has 'Client' selected. The 'IP Address' field contains '10.200.7.198'. The 'COM' field is set to '22' and the 'Remote Port' field is set to '23'. The 'Enable Control Connection' checkbox is checked. The reconnection interval is set to '1' second(s).

Select the display you want to control from the table and accept defaults, as shown. Make a note of the COM number assigned to the new VCOM port. Click OK to create the new port. The new port appears in the COM Mapping table.

You can view details for the virtual COM port device using Device Manager, shown below.

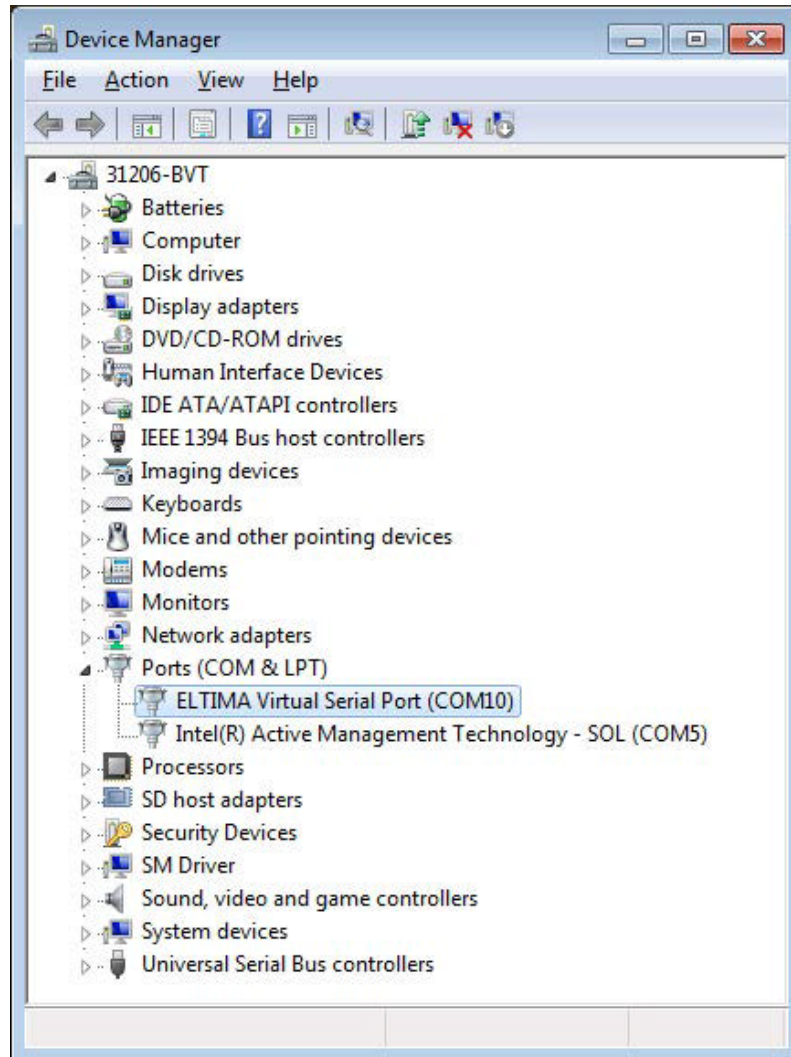

Removing a COM Port

On the COM Mapping page, select the COM port you want to delete and click the REMOVE button.

Setting Up Email Alerts

The web service allows you to configure the settings required to send email alerts. If you are not using email alerts, you do not need to use the web service and can skip this section.

Login

When you direct your browser to the network IP address of the display, you are prompted to login as shown here.

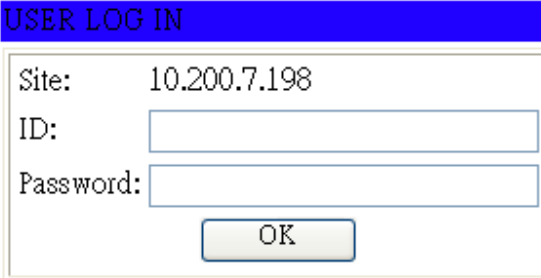

USER LOG IN

Site: 10.200.7.198

ID:

Password:

OK

The default ID is **admin** and the default password is **system**.

Note: Cookies and JavaScript must be enabled in your browser.

Note: If your session times out or if you enter an incorrect ID or password, you will see the following message.

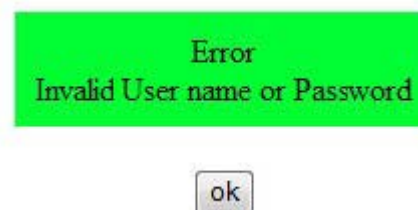

When you first login, you will see the System Status page, as shown here.



Administrator
[TCP Mode](#)
[UDP Mode](#)
[UART](#)
[SMTP](#)
[Reset Device](#)

System Status

Kernel Version	V2018 (Dec 08 2010 10:08:13)	
MAC Address	00:1F:B6:00:00:22	
Nickname	<input type="text" value="NetUART"/>	<input type="button" value="Update"/>

Please refresh web page after press "updated" button.

Note:
Comment name only can use "0-9","a-z","A-Z","_","-"

Administrator

Click on the word Administrator under the Planar logo to show/hide these menu items.

Authentication Configuration

Set user ID and password for login to the web service.

PLANAR
When image experience matters.

Administrator

- [Authentication Configuration](#)
- [System IP Configuration](#)
- [System Status](#)
- [Load default setting](#)
- [Firmware update](#)
- [Boot Loader upgrade](#)
- [TCP Mode](#)
- [UDP Mode](#)
- [UART](#)
- [SMTP](#)
- [Reset Device](#)

Authentication Configuration

Setting	Value
Username	admin max:15
Password Confirm max:15

Please refresh web page after press "updated" button.

Note:
Comment name only can use "0-9", "a-z", "A-Z"

System IP Configuration

You can view and/or change the network settings here. However, for best results, we recommend that you use the on-screen display menus, as described in "Advanced Settings - Ethernet Setup Submenu" on page 55.

PLANAR
When image experience matters.

Administrator

- [Authentication Configuration](#)
- [System IP Configuration](#)
- [System Status](#)
- [Load default setting](#)
- [Firmware update](#)
- [Boot Loader upgrade](#)
- [TCP Mode](#)
- [UDP Mode](#)
- [UART](#)
- [SMTP](#)
- [Reset Device](#)

System IP Configuration

Setting	Value
IP Address	192 . 168 . 2 . 1
Subnet Mask	255 . 255 . 255 . 0
Gateway	192 . 168 . 2 . 1
DNS	192 . 168 . 2 . 1
IP Configure	<input type="radio"/> Static <input checked="" type="radio"/> DHCP
VLAN Tag	<input checked="" type="radio"/> Disable <input type="radio"/> Enable : VLAN ID 0

Please refresh web page after press "updated" button.

If your network requires a VLAN tag, your network administrator will give you a number from 1 to 4094 to enter here.

System Status

- Kernel version - Shows the firmware version for the network interface.
- MAC Address - Shows the unique address assigned to the network interface.
- Nickname - Enter a device tag, up to 12 characters. This tag will appear in email alerts, which help you identify the source of the alert.

PLANAR
When image experience matters.

Administrator

- [Authentication Configuration](#)
- [System IP Configuration](#)
- [System Status](#)**
- [Load default setting](#)
- [Firmware update](#)
- [Boot Loader upgrade](#)
- [TCP Mode](#)
- [UDP Mode](#)
- [UART](#)
- [SMTP](#)
- [Reset Device](#)

System Status

Kernel Version	V2018 (Dec 08 2010 10:08:13)	
MAC Address	00:1F:B6:00:00:22	
Nickname	<input type="text" value="NetUART"/>	<input type="button" value="Update"/>

Please refresh web page after press "updated" button.

Note:
Comment name only can use "0-9", "a-z", "A-Z", "_", "-"

Load Default Setting

- 1 Click the LOAD button to return the network interface to default settings.

Load Default Setting to EEPROM

- 2 After a few seconds, you will see a green box with the message "Setting Saved RESET." Click the RESET button to restart the network interface.

Setting Saved
RESET

- 3 Make sure the IP address in your browser is correct and then click OK.



- 4 When the process is complete, you should see the login page again.

Firmware Update and Boot Loader Upgrade

In most cases, you will not need to update firmware for the network interface. If you do, contact Planar's Technical Support Department. See "Accessing Planar's Technical Support Website" on page 90 for more information.

WARNING! Do not use the controls in these two sections unless you have received a specific procedure and firmware from Planar. Following improper procedures can disable the network interface and require factory repair service.

TCP Mode, UDP Mode and UART

For normal operation, you will not need to change any settings on these pages. If you do need to change information, Planar's Technical Support Department will provide you with more information.

SMTP

SMTP setup

Enable SMTP	<input type="checkbox"/> Enable, Port: 25
SMTP server address	smtp.xxx.yyy
SMTP Login Information	<input type="checkbox"/> Enable Username: username, Password: ●●●●●●
Mail to	xxx@yyy.zzz max: 200
Mail from	xxx@yyy.zzz

Your network administrator must provide information for the following fields:

- Enable SMTP - Make sure this checkbox is checked. Port 25 is the default.
- SMTP Server Address - Name or IP address of the mail server.
- SMTP Login Information - If required, check the ENABLE box and enter a username and password.
- Mail to - Enter the destination email addresses. Separate multiple addresses with a semi-colon.
- Mail from - Enter the email address from which you want to send alerts.

SMTP 01 Warning	
Subject	Power Status Change Alert
Message Body	SMTP 01 bcdy max: 100

SMTP 02 Warning	
Subject	Source Change Alert
Message Body	SMTP 02 bcdy max: 100

SMTP 03 Warning	
Subject	Signal Lost Alert
Message Body	SMTP 03 bcdy max: 100

You can edit the subject and body of the email warnings, which are sent when there is a power status change, source change and signal lost. The SMTP 04 and 05 warnings are not used.

Reset Device

Click the RESET button to reboot the network interface. Note that the current settings are not changed.

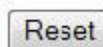

Signal Compatibility

Timing		fH (KHz)	fV (Hz)	Dot clock (MHz)	HDMI	VGA	DVI	DisplayPort	
VESA	VGA 640 x 480	31.469	59.94	25.175	0	0	0	0	
		37.861	72.809	31.5	0	0	0	0	
		37.5	75	31.5	0	0	0	0	
		43.269	85.008	36	0	0	0	0	
	SVGA 800 x 600	35.156	56.25	36	0	0	0	0	
		37.879	60.317	40	0	0	0	0	
		48.077	72.188	50	0	0	0	0	
		46.875	75	49.5	0	0	0	0	
		53.674	85.06	56.25	0	0	0	0	
	XGA 1024 x 768	48.363	60.004	65	0	0	0	0	
		56.476	70.069	75	0	0	0	0	
		60.023	75.029	78.75	0	0	0	0	
		68.677	84.997	94.5	0	0	0	0	
	WUXGA1360 x 768	47.712	60,015	85.5	0	0	0	0	
	1280 x 720	44.444	59.98	64	0	0	0	0	
		44.772	59.86	74.5	0	0	0	0	
		56.456	74.78	95.75	0	0	0	0	
	1280 x 768	47.776	59.87	79.5	0	0	0	0	
		47.396	59.995	68.25	0	0	0	0	
		68.633	84.837	117.5	0	0	0	0	
	1280 x 800	49.306	59.91	71	0	0	0	0	
		49.702	59.81	83	0	0	0	0	
	SXGA	1152 x 864	67.5	75	108	0	0	0	0
			63.981	60.02	108	0	0	0	0
1280 x 1024		79.976	75.025	135	0	0	0	0	
		91.146	85.024	157.5	0	0	0	0	

Timing		fH (KHz)	fV (Hz)	Dot clock (MHz)	HDMI	VGA	DVI	DisplayPort
VESA	1440 x 900	55.469	59.901	88.75	0	0	0	0
		55.935	59.88	106.5	0	0	0	0
	WSXGA+ 1680 x 1050	64.674	59.883	119	0	0	0	0
		65.29	59.954	146.25	0	0	0	0
	UXGA 1600 x 1200	75	60	162	0	0	0	0
	1920 x 1080	66.587	59.93	138.5	0	0	0	0
	WUXGA 1920 x 1200	74.038	59.95	154	0	0	0	0
EDTV	480p	31.5	60	27.03	0	-	0	0
	576p	31.25	50	27	0	-	0	0
HDTV	720p 1280 x 720	37.5	50	74.25	0	-	0	0
		44.995	59.94	74.176	0	-	0	0
		45	60	74.25	0	-	0	0
	1080i 1920 x 1080	28.13	50	74.25	0	-	0	0
		33.716	59.94	74.176	0	-	0	0
		33.75	60	74.25	0	-	0	0
	1080p 1920 x 1080	27	24	74.25	0	-	0	0
		28.125	25	74.25	0	-	0	0
		33.75	30	74.25	0	-	0	0
		56.25	50	148.5	0	-	0	0
67.433		59.94	148.352	0	-	0	0	
	67.5	60	148.5	0	0	0	0	
4K2K	3840x2160	54	24	297	0	-	-	0
		56.25	25	297	0	-	-	0
		67.5	30	297	0	-	-	0

Specifications

Item	Model	Specification	
LCD panel	Resolution	3840 x 2160	
	Aspect Ratio	16:9	
	Screen Size	EP5804K(-T)	58"
		EP6504K(-T)	65"
	Orientation	Landscape/Portrait	
	Brightness (typ.)	EP5804K	400 cd/m ²
		EP5804K-T	400 cd/m ²
		EP6504K	350 cd/m ²
		EP6504K-T	350 cd/m ²
	Contrast Ratio	5000:1	
	Viewing Angle (Typ.)	178°	
	Response Time	6.5 ms	
	Input Frame Rate	FHD 50/60Hz, FHD 100/120Hz, QFHD 24/30Hz	
	Color Gamut	72% NTSC	
	Display Color	1.07G colors	
	Pixel Pitch	EP5804K(-T)	0.334(H) x 0.334(V)
		EP6504K(-T)	0.248 (H) x 0.744 (V)
	Display Active Area (in mm)	EP5804K(-T)	1270.08 (H) x 721.44 (V)
EP6504K(-T)		1428.48 (H) x 803.52 (V)	
Auto Brightness Control		Ambient Light Sensor	
Features		OPS Slot, On/Off Scheduling	
Touch	Touch Technology	EP5804K-T	6 pt IR
		EP6504K-T	6 pt IR
	Supporting OS		Windows 8, 7, Vista, XP, Mac OSX, and Linux

Connectivity	Standard Inputs	EP5804K	HDMI x 2 / DisplayPort In/Out/ DVI / VGA / IR	
		EP5804K-T	HDMI x 2 / DisplayPort In/Out/ DVI / VGA / IR / USB for Touch	
		EP6504K	HDMI x 2 / DisplayPort In/Out/ DVI / VGA / IR	
		EP6504K-T	HDMI x 2 / DisplayPort In/Out/ DVI / VGA / IR / USB for Touch	
	Audio Input		PC Audio In (Jack)	
	Audio Output		R/L Line Out (Jack)	
	Control and Monitoring		LAN RJ45, RS232 In, IR, Keypad (lockable)	
Mechanical	Display Weight	EP5804K	Display Weight: 79 lbs (36 kg); Shipping Weight: 101 lbs (46 kg)	
		EP5804K-T	Display Weight: 106 lbs (48 kg); Shipping Weight: 128 lbs (58 kg)	
		EP6504K	Display Weight: 106 lbs (48.2 kg); Shipping Weight: 134 lbs (61 kg)	
		EP6504K-T	Display Weight: 132 lbs (60.2 kg); Shipping Weight: 161 lbs (73 kg)	
	Mounting	EP5804K(-T)	VESA 400 mm x 200 mm	
		EP6504K(-T)	VESA 400 mm x 400 mm	
	Display Dimensions	EP5804K	51.2" x 29.6" x 3.2" (1300.7 mm x 752.1 mm x 80.1 mm)	
		EP5804K-T	51.8" x 30.1" x 3.8" (1315.0 mm x 764.2 mm x 96.2 mm)	
		EP6504K	57.5" x 32.9" x 3.3" (1460.0 mm x 835.0 mm x 83.2 mm)	
		EP6504K-T	58.4" x 33.5" x 3.9" (1483.8 mm x 852.0 mm x 99.7) mm	
	Bezel Width	EP5804K	0.6" (14.0 mm)	
		EP5804K-T	0.7" (19.3 mm)	
		EP6504K	0.6 (14.0 mm)	
		EP6504K-T	0.8" (20.0 mm)	
	Enclosure		Metal, Industrial	
	Fanless		Yes	
	Speakers		10W x 2 Built-In	
	Usage	Recommended Usage		Up to 24x7 Operation
		Backlight		E-LED
		Backlight Life		50,000 Hours

Specifications

Power Source	Input Voltage/ Frequency		AC 100V~240V; 50-60 Hz
Environment	Storage Temperature		Min -4°F ~ Max 140° F (-20°C ~ Max 60°C)
	Operating Temperature		Min 32°F ~ 104°F (0°C ~ Max 40°C) <9842 ft (3000 m) altitude
	Humidity		20~90% RH
	Approvals		FCC Class A, UL, CE

Troubleshooting

Before calling service personnel, please check the following table for a possible cause of the problem you are experiencing. Please note the following:

- Perform the adjustments according to "Operating the Display" on page 20.
- If the problem you have experienced isn't described below or you can't correct the problem, stop using the display and contact Planar's Technical Support Department. (See "Accessing Planar's Technical Support Website" on page 90)

Issue	Check for the following
No image is displayed	Make sure the correct source is selected.
	Make sure the main power switch is turned ON.
	Check that the source equipment is operating correctly.
	Make sure the input signal is compatible with this display.
The image is not centered	Make sure the input signal is compatible with this display.
The remote control doesn't work	Make sure the batteries are new and are installed correctly. Ensure the remote is aimed at the IR sensor.
	Make sure the remote control sensor is plugged in correctly.
	Make sure the remote is aimed towards the back of the display, where the sensor is located.
The picture color looks poor	Check the picture settings. Reset the display.
	If you are using YUV terminals, make sure cables are correctly connected.
	Check ADC calibration. (See "Advanced Settings - User ADC Calibration" on page 57)

Accessing Planar's Technical Support Website

Go to <http://www.planar.com/support> to locate the following support documents and resources:

- User Guide
- RS232 User Manual
- Touchscreen drivers
- Standard warranties
- Planar support hotline number and email

Index

A

accessory kit, 10
adjusting volume, 27
administrator in web service, 79
advanced settings menu, 40, 52
audio settings menu, 38, 45
authentication configuration page, 79
avoiding temporary image retention, 4

B

basic settings menu, 38, 46
batteries
 changing in the remote, 26

C

cable clamps
 installation, 12
cleaning the display, 7
Connecting the Touchscreen, 63
cooling requirements, 6

D

default display settings, 62
default setting
 loading in web service, 80
dimensions, 13
display settings menu, 37, 44

E

exemptions for product use, 8

H

HD-SDI board
 installing, 20

I

image settings menu, 37, 42
input source
 selecting, 28
installation, 18
 cable clamps, 12
 HD-SDI board, 20
 OPS expansion slot, 19
 safety precautions, 3
introduction, 1
ip system configuration, 79

L

LAN control, 67
locking, 25

M

menus
 advanced settings, 52
 audio settings, 45
 basic settings, 46
 display settings, 44
 image settings menu, 42
 system, 61
 using, 41
multi-display control menu, 41

N

navigating, 41
navigating menus, 41
network interface
 resetting, 83
network settings menu, 40
normal usage guidelines, 6

O

OPS expansion slot
 installation, 19
osd menus, 25, 37, 41
 advanced settings, 40
 audio settings, 38
 basic settings, 38
 display settings, 37
 functions, 29
 image settings, 37
 multi-display control, 41
 network settings, 40
 RTC, 39
 system status, 39, 41
 unlocking, 25

P

package contents, 8
PIP mode, 29
product usage
 exemptions, 8

R

recommended usage, 4
remote control
 changing the batteries, 26
 using, 23
resetting the network interface, 83
RS232 network connection, 67
RTC menus, 39

S

safety
 during installation, 3
 information, 2
 precautions, 2
 precautions during use, 4
selecting input source, 28
service plans, ii
settings
 default, 62
signal compatibility, 84
signal source input, 19

SMTP setup page, 82
specifications, 86
supported timings, 84
system ip configuration page, 79
system status menu, 39, 41, 61
system status page, 78, 80

T

temporary image retention
 avoiding, 4
 definition, 4
timings, 84
TIR *see temporary image retention*
touchscreen
 using the touchscreen, 63
troubleshooting, 89
turning off the displays, 27
turning on the displays, 26

U

unpacking the displays, 8
using the remote, 23

V

VCOM
 configuration, 71
 driver installation, 68
vesa mounts, 6
volume, 27

W

warranty
 exemptions, 8
 information, ii
web service, 77
 administrator, 79
 authentication configuration, 79
 loading default setting, 80
 reset device, 83
 SMTP setup page, 82
 system ip configuration, 79
 system status, 78
 system status page, 80

