



PD370/PD420/PD470/PD520
Special Home Theater Display
User's Manual

www.PlanarHomeTheater.com

Planar Systems, Inc.

Corporate Headquarters
1195 NW Compton Drive
Beaverton, OR 97006-1992

Planar Customer Support

Telephone:

US: 1-866-PLANAR1 (866) 752-6271

Outside US: (503) 748-5799

E-mail: PlanarSupport@planar.com

Online Technical Library: <http://www.planar.com/support>

Hours: M-F, 3am-7pm ET, 11am-3am GMT

Preface

About this manual

This manual is designed for use with the PD370/PD420/PD470/PD520 Home Theater. Information in this document has been carefully checked for accuracy; however, no guarantee is given to the correctness of the contents. The information in this document is subject to change without notice.

Copyright

Copyright 2007

This document contains proprietary information protected by copyright. All rights are reserved. No part of this manual may be reproduced by any mechanical, electronic or other means, in any form, without prior written permission of the manufacturer.

Trademarks

All trademarks and registered trademarks are the property of their respective owners.

FCC compliance

This device complies with Part 15 of the FCC Rules. Operation is subject to the following two conditions.

- (1) This device may not cause harmful interference, and
- (2) This device must accept any interference received, including interference that may cause undesired operation.

Federal communications commission (FCC) statement

This equipment has been tested and found to comply with the limits for a Class B digital device, pursuant to part 15 of the FCC Rules. These limits are designed to provide reasonable protection against harmful interference in a residential installation. This equipment generates, uses and can radiate radio frequency energy and, if not installed and used in accordance with the instructions, may cause harmful interference to radio communications. However, there is no guarantee that interference will not occur in a particular installation. If this equipment does cause harmful interference to radio or television reception, which can be determined by turning the equipment off and on, the user is encouraged to try to correct the interference by one or more of the following measures:

- ◆ Reorient or relocate the receiving antenna.
- ◆ Increase the separation between the equipment and the receiver.
- ◆ Connect the equipment to an outlet on a circuit different from that to which the receiver is connected.
- ◆ Consult the dealer or an experienced radio/TV technician for help.

Important recycling instructions

	<p>Lamp(s) inside this product contains mercury. This product may contain other electronic waste that can be hazardous if not disposed of properly. Recycle or dispose in accordance with local, state, or federal laws. For more information, contact the Electronic industries Alliance at WWW.EIAE.ORG For lamp specific disposal information check WWW.LAMPRECYCLE.ORG</p>
---	---

Symbol explanations

	<p>Disposal: Do not use household or municipal waste collection services for disposal of electrical and electronic equipment. EU countries require the use of separate recycling collection services.</p>
---	---

Register your Planar product today

Thank you for choosing Planar. To assure you receive all the benefits of your Planar product and services, register your Planar product today. Visit our website:

http://www.planar.com/support/product_registration.html

Cables and accessories

To find cables and accessories for your Planar product, visit our online store: www.PlanarOnline.com or find other stores that stock Planar products at <http://www.planar.com/howtobuy>.

Table of Contents

Important Safety Instructions.....	5
Overview.....	7
Features.....	7
Package Contents.....	7
Identifying Controls and Connections.....	8
Front Panel.....	8
Control Panel.....	8
Connection Panel.....	8
Connection Panel continued.....	9
Rear panel.....	9
Installation.....	10
Setup.....	10
Notes.....	10
Unpacking.....	10
This monitor can be connected to any video source equipment utilizing the following interfaces:.....	10
Connecting the Power Cord.....	10
Connecting to Video Equipment.....	10
Connecting Using HDMI Cable (BEST).....	10
Connecting to Component Video Equipment (BETTER).....	10
Using a S-video or a Composite Video Cable (VIDEO/S-VIDEO) (GOOD).....	10
Connecting to a Computer.....	10
Basic operation.....	11
Info.....	11
A. Connecting the Power Cable.....	11
B. Turning Power On.....	11
C. Selecting Input Source.....	11
D. Turning Power Off.....	11
Using the Menu Screen.....	11
Remote control.....	12
OSD (On Screen Display) Menu Function.....	13
OSD Operation.....	16
Structure of OSD Menus (PC Mode).....	16
A. Image Setting.....	16
B. Display Setting.....	16
C. Audio Setting.....	17
D. Setup.....	17
E. Menu Setting.....	17
F. Clock/Timer Setting.....	18
Structure of OSD Menus (Video Mode).....	18
A. Image Setting.....	18
B. Display Setting.....	19
C. Audio Setting.....	19
D. Setup.....	19
E. Menu Setting.....	20
F. Clock/Timer Setting.....	20
Troubleshooting.....	21
Product specifications.....	22
Declaration of Conformity.....	24

Important Safety Instructions

This product is designed and manufactured to operate within defined design limits, and misuse may result in electric shock or fire. To prevent the product from being damaged, the following rules should be observed for the installation, use and maintenance of the product. Read the following safety instructions before operating the display. Keep these instructions in a safe place for future reference.

- ◆ To avoid the risk of electric shock or component damage, switch off the power before connecting other components to the monitor.
- ◆ Unplug the power cord before cleaning the monitor. A damp cloth is sufficient for cleaning the monitor. Do not use a liquid or a spray cleaner for cleaning the product. Do not use abrasive cleaners.
- ◆ Always use the accessories recommended by the manufacturer to insure compatibility.
- ◆ When moving the monitor from an area of low temperature to an area of high temperature, condensation may form on the housing. Do not turn on the monitor immediately after this to avoid causing fire, electric shock or component damage.
- ◆ Do not place the monitor on an unstable cart, stand, or table. If the monitor falls, it can injure a person and cause serious damage to the appliance. Use only a cart or stand recommended by the manufacturer or sold with the monitor.
- ◆ A distance of at least 3 feet should be maintained between the monitor and any heat source, i.e. radiator, heater, oven, amplifier etc. Do not install the product close to smoke. Operating the product close to smoke or moisture may cause fire or electric shock.
- ◆ Slots and openings in the back and bottom of the cabinet are provided for ventilation. To ensure reliable operation of the monitor and to protect it from overheating, be sure these openings are not blocked or covered. Do not place the monitor in a bookcase or cabinet unless proper ventilation is provided.
- ◆ Never push any object into the slot on the monitor cabinet. Do not place any objects on the top of the product. It could short circuit parts causing a fire or electric shock. Never spill liquids on the monitor.
- ◆ The monitor should be operated only from the type of power source indicated on the label. If you are not sure of the type of power supplied to your home, consult your dealer or local power company.
- ◆ The power cable must be replaced when using different voltage from that specified in the User Manual. For more information, contact your dealer.
- ◆ Do not overload power strips and extension cords. Overloading can result in fire or electric shock.
- ◆ The wall socket shall be installed near the equipment and shall be easily accessible.
- ◆ Only the marked power source can be used for the product. Any power source other than the specified one may cause fire or electric shock.
- ◆ Do not touch the power cord during lightning. To avoid electric shock, avoid handling the power cord during electrical storms.
- ◆ Unplug the unit during a lightening storm or when it will not be used for long period of time. This will protect the monitor from damage due to power surges.
- ◆ Do not attempt to repair or service the product yourself. Opening or removing the back cover may expose you to high voltages, the risk of electric shock, and other hazards. If repair is required, please contact your dealer and refer all servicing to qualified service personnel.
- ◆ Keep the product away from moisture. Do not expose this appliance to rain or moisture. If water penetrates into the product, unplug the power cord and contact your dealer. Continuous use in

this case may result in fire or electric shock.

- ◆ Do not use the product if any abnormality occurs. If any smoke or odor becomes apparent, unplug the power cord and contact your dealer immediately. Do not try to repair the product yourself.
- ◆ Avoid using dropped or damaged appliances. If the product is dropped and the housing is damaged, the internal components may function abnormally. Unplug the power cord immediately and contact your dealer for repair. Continued use of the product may cause fire or electric shock.
- ◆ Do not install the product in an area with heavy dust or high humidity. Operating the product in environments with heavy dust or high humidity may cause fire or electric shock.
- ◆ Follow instructions for moving the product. Ensure that the power connector and any other cables are unplugged before moving the product.
- ◆ Hold the power connector when removing the power cable. Pulling the power cable itself may damage the wires inside the cable and cause fire or electric shock. When the product will not be used for an extended period of time, unplug the power connector.
- ◆ To avoid risk of electric shock, do not touch the connector with wet hands.
- ◆ Insert batteries in accordance with instructions. Incorrect polarities may cause damage and leakage of the batteries, operator injury and contamination the remote controller.
- ◆ If any of the following occurs please contact the dealer.

Overview

PD370/PD420/PD470/PD520 are native 1920 x 1080 HDTV monitors and can display true 16.7M colors (8-bit/color).

Features

- High brightness
- Dynamic contrast ratio (**except PD370**)
- Fast response time
- High color saturation
- Max resolution 1920 x 1080(Full HD format)
- Ultra wide viewing angle :176(H)/ 176(V)
- Support PIP/PAP function
- OSD in 12 languages
- 2 HDMI inputs with HDCP key protection
- Rear IR sensor
- Tablestand included

Package Contents

Open the package and ensure that you have the following items:

	Item
1	Power cord US type.
2	Power cord UK type.
3	Power cord EU type.
4	Component Cable
5	Remote Control with AAA batteries
6	CD (User's manual)
7	User's Guide
8	Finishing Cloth

Identifying Controls and Connections

Front Panel

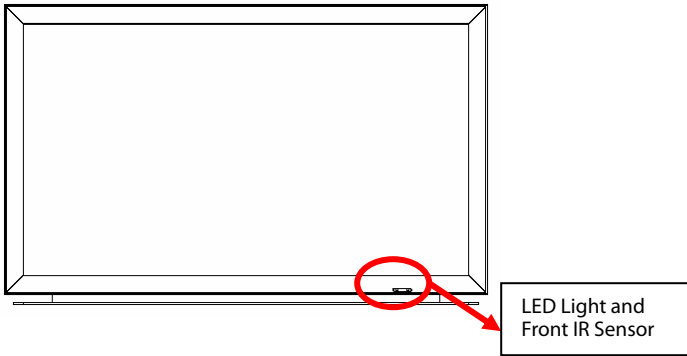

Control Panel

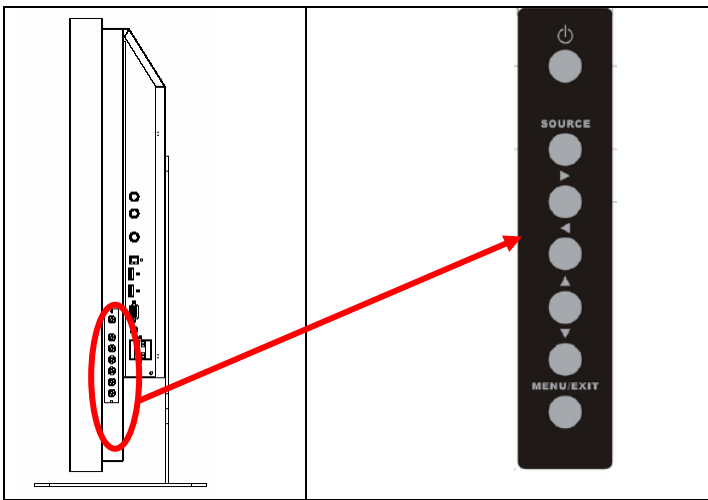

Connection Panel

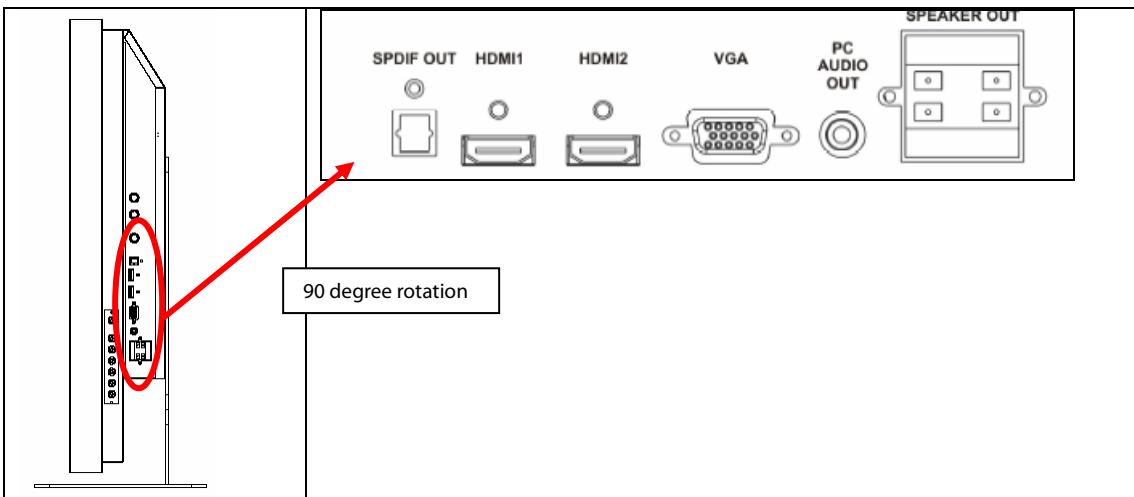

Connection Panel continued

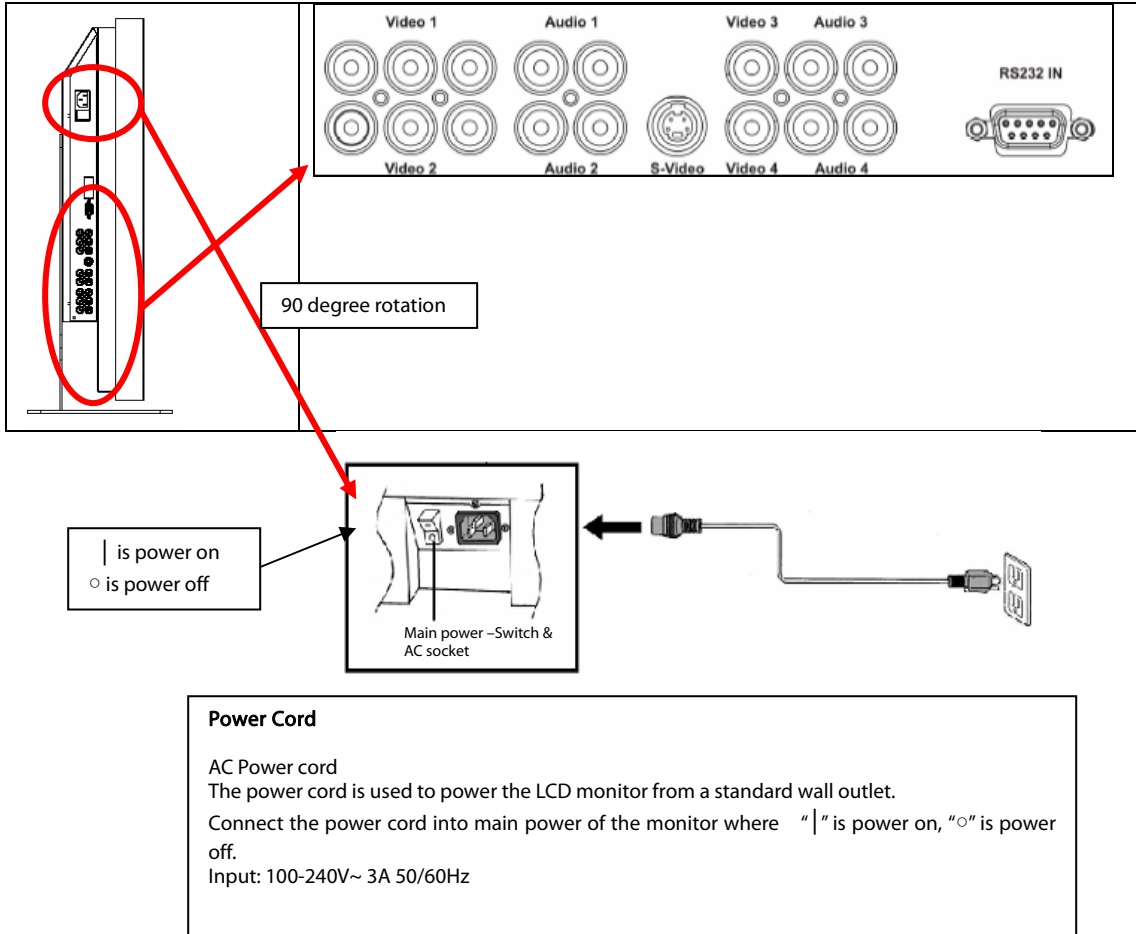

Note: PD520 signal connections are on the left side only when viewing the monitor from the rear as shown in the next figure. The PD520 power connection is on the right side from the same perspective.

Rear panel

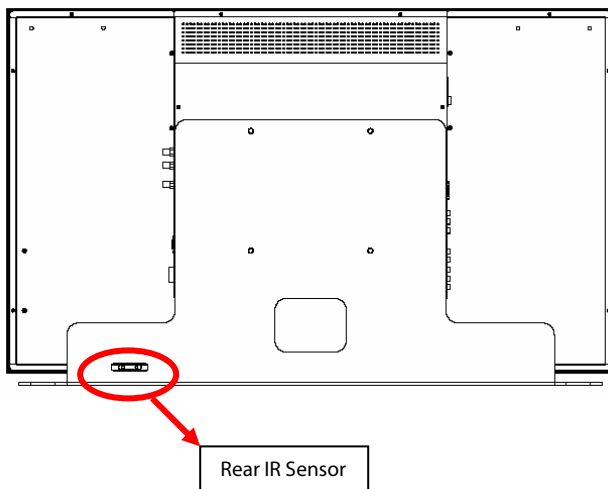

Installation

Setup

Notes

- Before connecting, turn off the monitor and any connected source equipment. After making all connections, turn on the monitor first before turning on other devices.
When connecting a computer, be sure that the computer is the last device turned on, after all connections are made.
- Read the operation manuals of the video source equipment before making connections.

Unpacking

- ◆ PD370/PD420/PD470/PD520 is packed inside a boxed carton. In order to protect the monitor during transportation, additional packing material has been placed within the carton.
- ◆ Before unpacking your monitor, prepare a stable, level, and clean surface near a wall outlet for your monitor.
- ◆ Set the monitor box in an upright position and open from the top of the box before removing the top packaging material.

This monitor can be connected to any video source equipment utilizing the following interfaces:

- ◆ High Definition Multimedia Interface (HDMI)
- ◆ Component (YPbPr)
- ◆ Composite Video
- ◆ S-Video
- ◆ HD-15 for VGA
- ◆ SCART (using Component 1 and Video 1)

Connecting the Power Cord

Plug the supplied power cord into the AC socket on the rear of the monitor.

Connecting to Video Equipment

Connecting Using HDMI Cable (BEST)

Use a HDMI cable when connecting to video sources that utilize HDMI output.

Connecting to Component Video Equipment (BETTER)

Use a component cable when connecting to video sources that utilize component interfaces for video connection.

Using a S-video or a Composite Video Cable (VIDEO/S-VIDEO) (GOOD)

Using a S-video or a composite video cable to connect to video sources that utilize s-video or composite interfaces for video

Connecting to a Computer

Connect the monitor to the computer using an HD 15-pin VGA cable. Secure the cable connectors by tightening the screws on both sides of the plug.

Basic operation

Connect the required external source equipment to the monitor before following these procedures.

Info

The OSD is automatically preset to English. To change the on-screen display language, refer to section E of the OSD Menu Function on page 19.

A. Connecting the Power Cable

Connect the power cord to the power cord connector on the back of the monitor. Plug the power cord into an AC wall socket and press power switch to "I" to power on, or "O" to power off the monitor.

B. Turning Power On

Once power switch is "on" (see above), press the Power ON button on the side of the monitor or remote control.

C. Selecting Input Source

To select the Input Source for the monitor, press the SOURCE button on the side of the monitor or press the desired source key on the remote control. Also, pressing the AUTO key on the remote control will cycle to the next active source input.

D. Turning Power Off

To turn off the monitor, press the Power OFF button on the side of the monitor or remote control.

Using the Menu Screen

The image and monitor settings can be adjusted through the MENU as listed on the monitor button panel or remote control using the following procedures:

Remote control

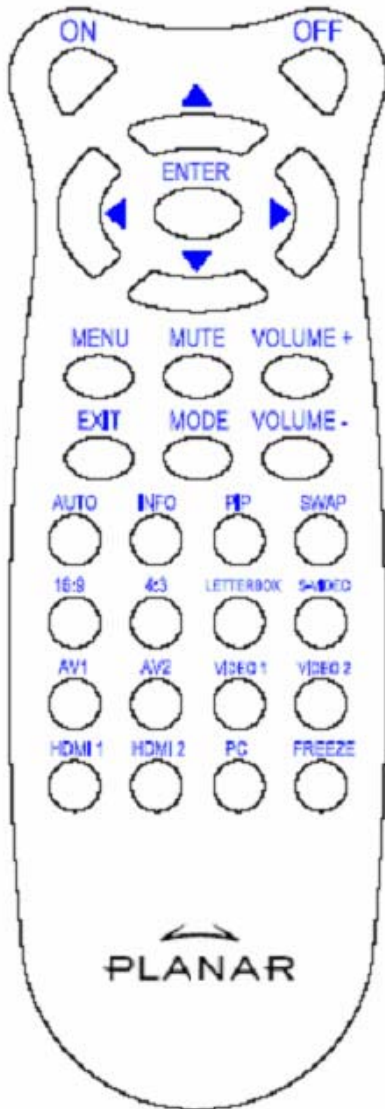

ITEM	FUNCTION
On	Monitor on
OFF	Monitor off
▲	Up
◀	Left
▶	Right
▼	Down
ENTER	Enter
MENU	To enter OSD menu
MUTE	Audio mute
Volume +	Volume increase
Volume -	Volume decrease
EXIT	Exit
MODE	To choose display mode (Sport, Theater, Game, Vivid, User defined)
AUTO	Search next active port
INFO	To indicate the status
PIP	To choose PIP/PBP function
SWAP	To exchange PIP/PBP function
16:9	Aspect ratio 16:9
4:3	Aspect ratio 4:3
Letterbox	To choose letterbox aspect ratio
S-Video	To choose S-Video source
AV1	To choose Composite source 1
AV2	To choose Composite source 2
Video 1	To choose Component source 1
Video 2	To choose Component source 2
HDMI 1	To choose HDMI source 1
HDMI 2	To choose HDMI source 2
PC	For VGA choice
Freeze	To freeze the display motion

Note 1: Inserting the batteries

Insert two AAA batteries into the remote control. Make sure the (+) and (-) symbols on the batteries are matched with the (+) and (-) symbols inside the battery compartment. Re-attach the battery cover.

Note 2: Precautionary Tips for Inserting the Batteries:

- ◆ Only use the specified AAA batteries.
- ◆ Do not mix new and old batteries. This may result in cracking or leakage that may pose a fire risk or lead to personal injury.
- ◆ Inserting the batteries incorrectly may also result in cracking or leakage that may pose a fire risk or lead to personal injury.
- ◆ Dispose of the batteries in accordance with local laws and regulations. Keep the batteries away from children and pets.

OSD (On Screen Display) Menu Function

Video Mode

Main Menu	Sub-Menu	Sub-Submenu	Description	Setting	
Image Settings	Scheme		Choose display mode	User, Sport, Game, Theater, Vivid	
	Brightness		Adjust the brightness of the screen	0~100	
	Contrast		Adjust the contrast of the screen	0~100	
	Saturation		Adjust the picture saturation of the screen	0~100	
	Hue		Adjust the picture hue of the screen	0~100	
	Sharpness		Adjust the sharpness of the screen	0~24	
	Reset		Reset to the default value	Yes, No	
	Advanced	Gamma		Adjust the Gamma level of the screen	, 1.8, 2.2, 2.5
		Color Temps		Adjust the color temperature of the screen	, User,5000K, 6500K, 7500K,9300K
		Dynamic contrast		Enable dynamic contrast ratio	On, Off
Temporal NR			Adjust the noise deduction	Low, Adaptive, Off, High, Medium,	
MPEG NR			Adjust MPEG NR	0~63	
Display Settings	Aspect Ratio		Adjust the aspect ratio of the screen	16:9, 4:3, Letter Box, Native	
	Overscan		Adjust overscan	0~10	
	Top Mask		Choose top mask	0~100	
	Bottom Mask		Choose bottom mask	0~100	
	Reset		Reset to the default value	Yes, No	
Audio Settings	Stereo/SAP		Choose the audio mode	Stereo, Mono, SAP	
	Bass		Adjust Bass volume	-10~10	
	Treble		Adjust Treble volume	-10~10	
	Balance		Adjust the balance of the screen	-10~10	
	Reset		Reset to the default value	Yes, No	
Setup	Main Auto Scan		Auto Scan	On, Off	
	Main Source Select	Main Source Select	Select Main Source	Searching, PC, HDMI 1, HDMI 2, Video 1, Video 2, AV1, AV2, S-Video, SCART	
		Main Source Activate	Activate the main source (Enable or Disable)	PC, HDMI 1, HDMI 2, Video 1, Video 2, AV1, AV2, S-Video, SCART	
	PIP Auto Scan		Scan PIP automatically	On, Off	
	PIP Source Select	PIP Source Select	Select PIP source	Searching, PC, HDMI 1, HDMI 2, Video 1, Video 2, AV1, AV2, S-Video, SCART, PIP Picture Off	
		PIP Source Activate	Active PIP source (Enable or Disable)	PC, HDMI 1, HDMI 2, Video 1, Video 2, AV1, AV2, S-Video, SCART	
	PIP Main Swap		Swap Main PIP		
	PIP Mode		Select PIP mode	Off, Large PIP, Small PIP, Side-by-Side	
PIP Position		Adjust PIP position	Bottom-Right, Top-Left, Top-Right, Bottom-Left, User		

	PIP Aspect Ratio			16:9, 4:3, Letter box
	Blank Color		Adjust the background color	Black, Blue
	Front LED		Select the front LED function	Off, On
	Factory Reset		Reset all to the factory settings	Yes, No
Menu Settings	Menu Zoom		Set the menu size	Off, On
	Transparency		Adjust OSD transparency	0~100
	Menu Language		Select the menu language	Dutch, English, French, German, Italian, Norwegian (Norway), Portuguese, Russian, Spanish, Swedish, Simplified Chinese, and Korean
	Menu Timeout		Set the menu timeout period	5~120 (Seconds)
	Menu Position		Adjust the menu position	-50~50 (vertical and horizontal)
	Reset		Reset to the default value	Yes, No
	Clock/Timer	Sleep Timer		
Status		Resolution	Show resolution status	
		Source	Show source status	
		Version	Show firmware version status	

PC Mode

Main Menu	Sub-Menu		Description	Setting	
Image Settings	Brightness		Adjust the brightness of the screen	0~100	
	Contrast		Adjust the contrast of the screen	0~100	
	Sharpness		Adjust the sharpness of the screen	0~24	
	Reset		Reset to the default value	Yes, No	
	Advanced	Gamma		Set the Gamma data	1.8,2.2,2.5
		Color Temps		Set the Color Temperature	User, 5000K, 6500K, 7500K, 9300K
		Dynamic contrast		Enable dynamic contrast ratio	On, Off
Display Settings	Aspect Ratio		Adjust the aspect ratio of the screen	16:9, 4:3, Letter Box, Native	
	Overscan			0~10	
	Top Mask			0~100	
	Bottom Mask			0~100	
	Reset		Reset to the default value	Yes, No	
	Auto Image		Select the auto image adjustment		
	Image Position		Adjust the image position		
	Phase		Adjust the phase position		
	Clocks/Line		Adjust the Clocks/Line		
Audio Settings	Stereo/SAP		Choose the audio mode	Stereo, Mono, SAP	
	Bass		Adjust Bass volume	-10~10	
	Treble		Adjust Treble volume	-10~10	

	Balance		Adjust the balance of the screen	-10~10
	Reset		Reset to the default value	Yes, No
Setup	Main Auto Scan			Off, On
	Main Source Select	Main Source Select	Select main source	Searching PC, HDMI 1, HDMI 2, Video 1, Video 2, AV1, AV2, S-Video, SCART
		Main Source Activate	Activate the main source (Enable or Disable)	PC, HDMI 1, HDMI 2, Video 1, Video 2, AV1, AV2, S-Video, SCART
	PIP Auto Select			Off, On
	PIP Source Select	PIP Source Select	Select PIP source	Searching HDMI 1, HDMI 2, Video 1, Video 2, AV1, AV2, S-Video, SCART, PIP Picture Off
		PIP Source Activate	Activate PIP Source(Enable or Disable)	PC, HDMI 1, HDMI 2, Video 1, Video 2, AV1, AV2, S-Video, SCART
	PIP Main Swap			
	PIP Mode		Select PIP mode	Off, Large PIP, Small PIP, Side-by-Side
	PIP Position		Adjust PIP position	Bottom-Right, Top-Left, Top-Right, Bottom-Left, User
	PIP Aspect Ratio			16:9, 4:3, Letter Box
	Blank Color		Adjust the background color	Black, Blue
	Front LED		Select the front LED function	Off, On
	Factory Reset		Reset to the factory setting	Yes, No
Menu Settings	Menu Zoom		Set the menu size	Off, On
	Transparency		Adjust OSD transparency	0~100
	Menu Language		Select the menu language	Dutch, English, French, German, Italian, Norwegian (Norway), Portuguese, Russian, Spanish, and Swedish
	Menu Timeout		Set the menu timeout period	5~120 (Seconds)
	Menu Position		Adjust the menu position	-50~50 (vertical and horizontal)
	Reset		Reset to the default value	Yes, No
	Clock/Timer	Sleep Timer		
Status		Resolution	Show resolution status	
		Source	Show source status	
		Version	Show version status	

OSD Operation

Structure of OSD Menus (PC Mode)

A. Image Setting

◆ On side of controller:

1. Press the "MENU/EXIT" to enter "Image Setting" item.
2. Press "▷" to enter sub-item menu (Brightness, contrast...),
3. Press "▽" or "△" to select items.
4. Press "▷" to enter sub-item for adjustment.
5. Press "▷" or "◁" to adjust.
6. Press "MENU/EXIT" to exit the item and save the adjusted value.

◆ On remote control:

1. Press the "MENU" to enter "Image Setting" item.
2. Press "▷" to enter sub-item menu (Brightness, contrast...)
3. Press "▽" or "△" to select items.
4. Press "ENTER" to enter sub-item for adjustment.
5. Press "▷" or "◁" to adjust.
6. Press "EXIT" to exit the item and save the adjusted value.

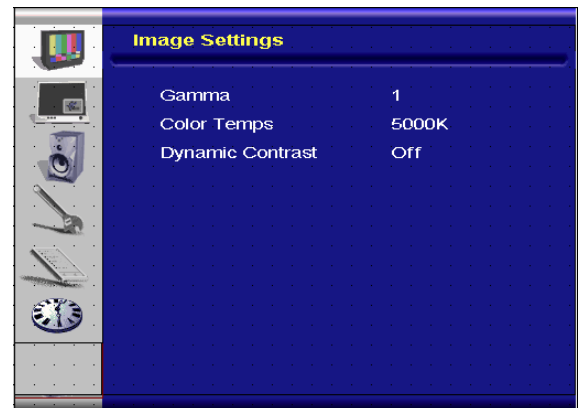
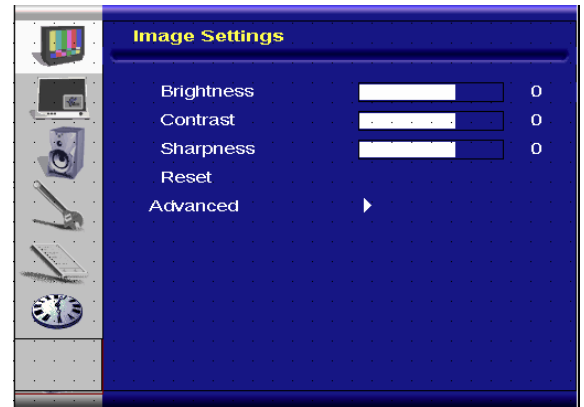

Advanced menu picture

B. Display Setting

◆ On side of controller:

1. Press the "MENU/EXIT" to enter "Display Settings" item.
2. Press "▷" to enter sub-item menu.
3. Press "▽" or "△" to select items.
4. Press "▷" to enter sub-item for adjustment.
5. Press "▷" or "◁" to adjust.
6. Press "MENU/EXIT" to exit the item and save the adjusted value.

◆ On remote control:

1. Press the "MENU" to enter "Display Settings" item.
2. Press "▷" to enter sub-item menu.
3. Press "▽" or "△" to select items.
4. Press "ENTER" to enter sub-item for adjustment.
5. Press "▷" or "◁" to adjust.
6. Press "EXIT" to exit the item and save the adjusted value.

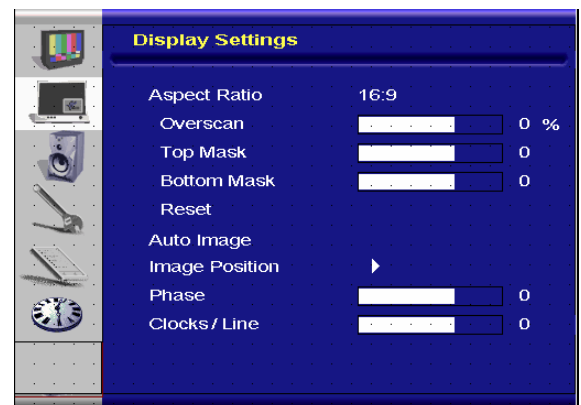

C. Audio Setting

◆ On side of controller:

1. Press the "MENU/EXIT" to enter "Audio Settings" item.
2. Press "▷" to enter sub-item menu.
3. Press "▽" or "△" to select items.
4. Press "▷" to enter sub-item for adjustment.
5. Press "▷" or "◁" to adjust.
6. Press "MENU/EXIT" to exit the item and save the adjusted value.

◆ On remote control:

1. Press the "MENU" to enter "Audio Settings" item.
2. Press "▷" to enter sub-item menu.
3. Press "▽" or "△" to select items.
4. Press "ENTER" to enter sub-item for adjustment.
5. Press "▷" or "◁" to adjust.
6. Press "EXIT" to exit the item and save the adjusted value.



D. Setup

◆ On side of controller:

1. Press the "MENU/EXIT" to enter "Setup" item.
2. Press "▷" to enter sub-item menu.
3. Press "▽" or "△" to select items.
4. Press "▷" to enter sub-item for adjustment.
5. Press "▷" or "◁" to adjust.
6. Press "MENU/EXIT" to exit the item and save the adjusted value.

◆ On REMOTE CONTROL:

1. Press the "MENU" to enter "Setup" item.
2. Press "▷" to enter sub-item menu.
3. Press "▽" or "△" to select items.
4. Press "ENTER" to enter sub-item for adjustment.
5. Press "▷" or "◁" to adjust.
6. Press "EXIT" to exit the item and save the adjusted value.

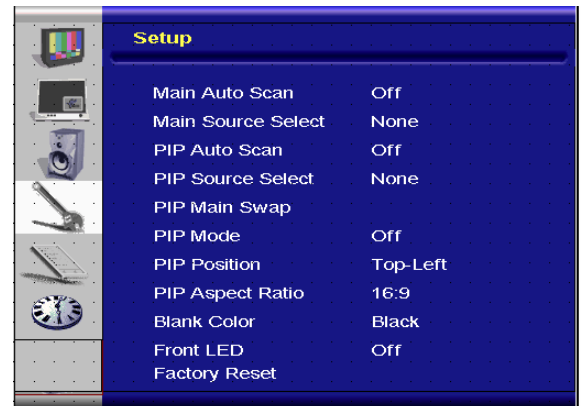

E. Menu Setting

◆ On side of controller:

1. Press the "MENU/EXIT" to enter "Menu Settings" item.
2. Press "▷" to enter sub-item menu.
3. Press "▽" or "△" to select items.
4. Press "▷" to enter sub-item for adjustment.
5. Press "▷" or "◁" to adjust.
6. Press "MENU/EXIT" to exit the item and save the adjusted value.

◆ On REMOTE CONTROL:

1. Press the "MENU" to enter "Menu Settings" item.
2. Press "▷" to enter sub-item menu.
3. Press "▽" or "△" to select items.
4. Press "ENTER" to enter sub-item for adjustment.

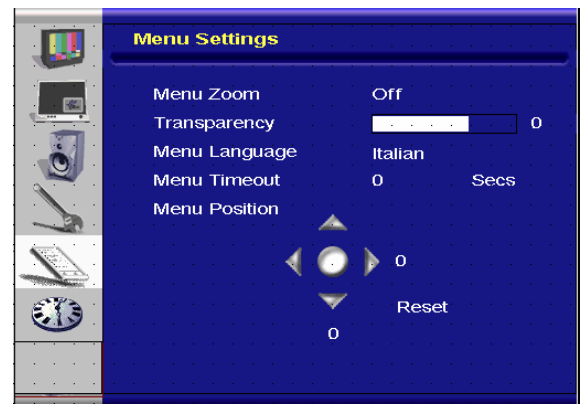

5. Press "▶" or "◀" to adjust.
6. Press "EXIT" to exit the item and save the adjusted value

F. Clock/Timer Setting

◆ On side of controller:

1. Press the "MENU/EXIT" to enter "Clock/Timer" item.
2. Press "▶" to enter sub-item menu.
3. Press "▼" or "▲" to select items.
4. Press "▶" to enter sub-item for adjustment.
5. Press "▶" or "◀" to adjust.
6. Press "MENU/EXIT" to exit the item and save the adjusted value.

◆ On REMOTE CONTROL:

1. Press the "MENU" to enter "Clock/Timer" item.
2. Press "▶" to enter sub-item menu.
3. Press "▼" or "▲" to select items.
4. Press "ENTER" to enter sub-item for adjustment.
5. Press "▶" or "◀" to adjust.
6. Press "EXIT" to exit the item and save the adjusted value

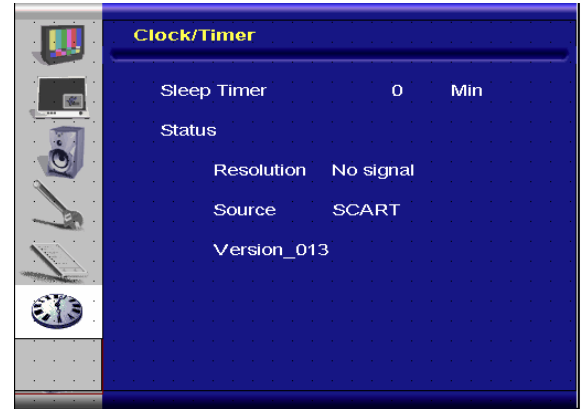

Structure of OSD Menu (Video Mode)

A. Image Setting

◆ On side of controller:

1. Press the "MENU/EXIT" to enter "Image Settings" item.
2. Press "▶" to enter sub-item menu (Brightness, contrast, Hue...),
3. Press "▼" or "▲" to select items.
4. Press "▶" to enter sub-item for adjustment.
5. Press "▶" or "◀" to adjust.
6. Press "MENU/EXIT" to exit the item and save the adjusted value.

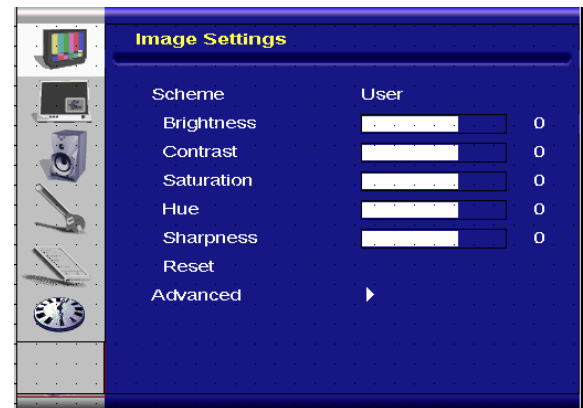

◆ On REMOTE CONTROL:

1. Press the "MENU" to enter "Image Settings" item.
2. Press "▶" to enter sub-item menu (Brightness, contrast, Hue...)
3. Press "▼" or "▲" to select items.
4. Press "ENTER" to enter sub-item for adjustment.
5. Press "▶" or "◀" to adjust.
6. Press "EXIT" to exit the item and save the adjusted value.

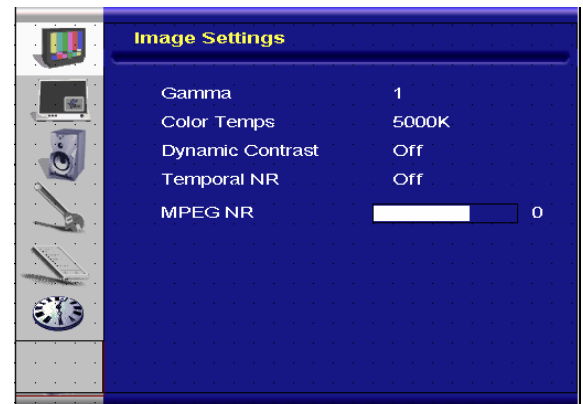

Advanced menu picture

B. Display Setting

◆ On side of controller:

1. Press the "MENU/EXIT" to enter "Display Settings" item.
2. Press "▶" to enter sub-item menu.
3. Press "▼" or "▲" to select items.
4. Press "▶" to enter sub-item for adjustment.
5. Press "▶" or "◀" to adjust.
6. Press "MENU/EXIT" to exit the item and save the adjusted value.

◆ On REMOTE CONTROL:

1. Press the "MENU" to enter "Display Settings" item.
2. Press "▶" to enter sub-item menu.
3. Press "▼" or "▲" to select items.
4. Press "ENTER" to enter sub-item for adjustment.
5. Press "▶" or "◀" to adjust.
6. Press "EXIT" to exit the item and save the adjusted value.

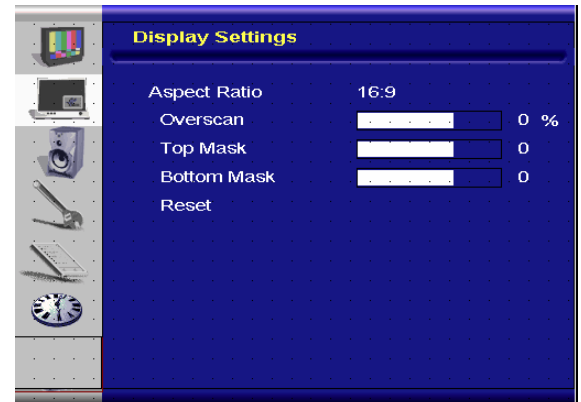

C. Audio Setting

◆ On side of controller:

1. Press the "MENU/EXIT" to enter "Audio Settings" item.
2. Press "▶" to enter sub-item menu.
3. Press "▼" or "▲" to select items.
4. Press "▶" to enter sub-item for adjustment.
5. Press "▶" or "◀" to adjust.
6. Press "MENU/EXIT" to exit the item and save the adjusted value.

◆ On REMOTE CONTROL:

1. Press the "MENU" to enter "Image Setting" item.
2. Press "▶" to enter sub-item menu.
3. Press "▼" or "▲" to select items.
4. Press "ENTER" to enter sub-item for adjustment.
5. Press "▶" or "◀" to adjust.
6. Press "EXIT" to exit the item and save the adjusted value.

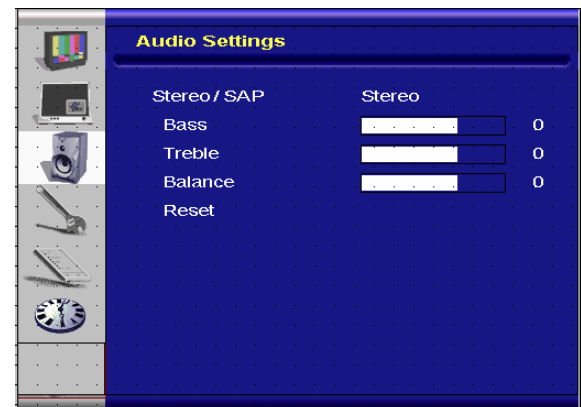

D. Setup

◆ On side of controller:

1. Press the "MENU/EXIT" to enter "Setup" item.
2. Press "▶" to enter sub-item menu.
3. Press "▼" or "▲" to select items.
4. Press "▶" to enter sub-item for adjustment.
5. Press "▶" or "◀" to adjust.
6. Press "MENU/EXIT" to exit the item and save the adjusted value.

◆ On REMOTE CONTROL:

1. Press the "MENU" to enter "Setup" item.
2. Press "▶" to enter sub-item menu.

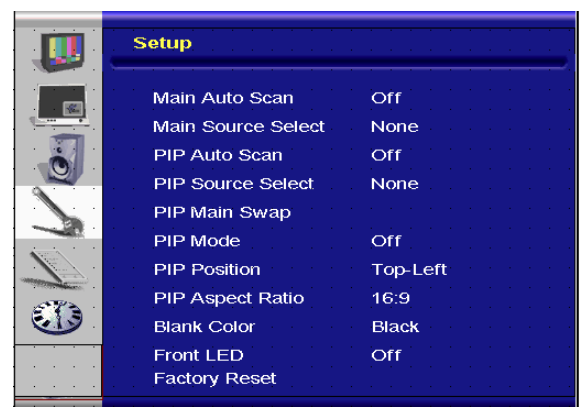

3. Press "▼" or "▲" to select items.
4. Press "ENTER" to enter sub-item for adjustment.
5. Press "▶" or "◀" to adjust.
6. Press "EXIT" to exit the item and save the adjusted value.

E. Menu Setting

◆ On side of controller:

1. Press the "MENU/EXIT" to enter "Menu Settings" item.
2. Press "▶" to enter sub-item menu.
3. Press "▼" or "▲" to select items.
4. Press "▶" to enter sub-item for adjustment.
5. Press "▶" or "◀" to adjust.
6. Press "MENU/EXIT" to exit the item and save the adjusted value.

◆ On REMOTE CONTROL:

1. Press the "MENU" to enter "Menu Settings" item.
2. Press "▶" to enter sub-item menu.
3. Press "▼" or "▲" to select items.
4. Press "ENTER" to enter sub-item for adjustment.
5. Press "▶" or "◀" to adjust.
6. Press "EXIT" to exit the item and save the adjusted value

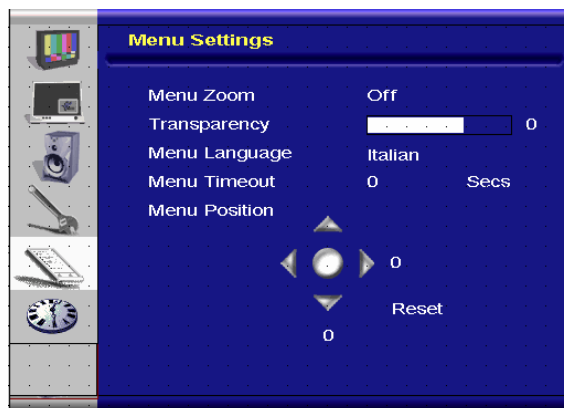

F. Clock/Timer Setting

◆ On side of controller:

1. Press the "MENU/EXIT" to enter "Clock/Timer" item.
2. Press "▶" to enter sub-item menu.
3. Press "▼" or "▲" to select items.
4. Press "▶" to enter sub-item for adjustment.
5. Press "▶" or "◀" to adjust.
6. Press "MENU/EXIT" to exit the item and save the adjusted value.

◆ On REMOTE CONTROL:

1. Press the "MENU" to enter "Clock/Timer" item.
2. Press "▶" to enter sub-item menu.
3. Press "▼" or "▲" to select items.
4. Press "ENTER" to enter sub-item for adjustment.
5. Press "▶" or "◀" to adjust.
6. Press "EXIT" to exit the item and save the adjusted value

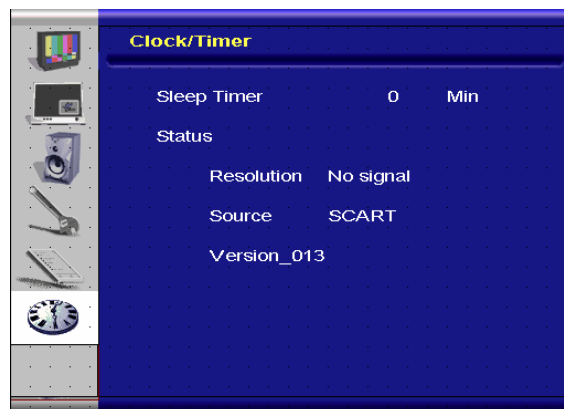

Troubleshooting

Before calling service personnel, please check the following chart for a possible solution:

No image appears	
Is the power cord of the monitor connected?	Check and see if the power cord is connected properly to the power outlet. Is the main power switch in the "I" position?
Is the power indicator amber?	If yes, press the "on" button on the remote control or side panel.

The screen color is not normal	
Is the screen color unstable or monochrome?	Check the connection of the source cable to ensure a proper fit.
Do you see black dots on the screen?	Clean surface with soft cloth.
Do you see a partial blurring on the screen?	This happens due to interference from surrounding magnetic fields, as created when speakers, steel structures, or high-voltage lines are placed near the monitor. Remove such materials from the immediate vicinity and use the OSD menu to adjust the screen.

Others	
The screen is flickering	1. Remove any highly magnetic material away from monitor. 2. Adjust graphic interface (PC Mode) within allotted frequency parameters.
The picture is dark	Adjust the backlight and brightness. It takes several seconds for the monitor to warm up after the power is turned on.
The picture appears to be ghosting	Ensure the source equipment connection cables are less than 15 meters (50ft.) If additional length is required, please contact your authorized dealer for a signal amplifier. (not provided)
The picture size is incorrect	Adjust picture format to desired image size.
White does not look white	Adjust the color temperature or alter "User" settings to preferred settings.
Screen image is not centered	Adjust picture format to desired image size.

Product specifications

Item		Specification				Unit
LCD Panel	Model no.	PD370	PD420	PD470	PD520	
	Resolution	1920 x 1080	1920 x 1080	1920 x 1080	1920 x 1080	
	Brightness	500	500	500	500	nits
	Contrast Ratio	1200:1	1500:1	1500:1	1500:1	
	Dynamic Contrast Ratio	NA	6000:1	6000:1	6000:1	
	Response time	Typ. 6.5 ms(Gray to Gray)				ms
	Aspect Ratio	16 : 9				
	Backlight Life Time	50,000				hrs
Graphic	Separate Sync.	TTL				-
	Horizontal Sync.	Positive / Negative				-
	Vertical Sync.	Positive / Negative				-
	Input Connector	HDMI1, HDMI2(Note 1), Video 1 (with Audio L/R) , Video 2 (with Audio L/R), S-Video, AV2(with Audio L/R), AV1(with Audio L/R), PC (with PC Audio In), SCART (Video1 with AV1(sync), S-PDIF, External SPK R/L OUT, RS232				-
Scan Rate	Horizontal	26~91				KHz
	Vertical	48~85				Hz
Performance	Auto Adjust	Clock, Phase, H-Position & V- Position				-
	Screen Scaling	VGA/SVGA/XGA/WXGA/HDTV Full Screen Display				-
	Power Management	VESA DPMS, DVI DMPM				-
	OSD Language	Dutch, English, French, German, Italian, Norwegian (Norway), Portuguese, Russian, Spanish, Swedish, Simplified Chinese, Korean				-
Power source	Power Input	AC100~240V (Worldwide)				V
	Minimum-Maximum	90~264V (refer to power spec)				V
Physical *need to add US measurements	Model no.	PD370	PD420	PD470	PD520	
	Dimension w/o stand	919*129*560	1016*130*609	1016*130*629	1269*140*766	mm
	Dimension w/o stand	36*5*22	40*5*24	40*5*25	50*6*30	inch
	Net weight	33	42	52	63	KG
	Net weight	73	93	115	139	Lbs
	Gross weight	39	49	61	74	KG

	Gross weight	86	108	135	163	Lbs
Environment	Storage Temperature	Min -5 ~ Max50 (add US measurements)				C
	Storage Temperature	Min 23~Max122				F
	Operating Temperature	Min 5 ~ Max 35 (add US measurements)				C
	Operating Temperature	Min41~Max95				
DCC	Plug & Play	DDC 2B Compliant				-
Function	OSD key	7 keys				Key
	Wall mount	VESA standard 200 x 200				mm
	Wall mount	7.87*7.87				inch
	RS232	2-way control, communication, firmware upgrade				-

Note 1: 2 HDMI inputs can not function at the same time with PIP/PBP.

Note 2: Video1 + AV1 = SCART (Scart connection is commonly used in Europe. SCART is supported by connecting to component (Video 1) and composite (AV1) (not supplied)

Declaration of Conformity

Manufacturer's Name: Planar Systems, Inc.

Manufacturer's Address: 1195 NW Compton Drive
Beaverton, OR 97006 USA

declares that the products

Model Numbers: PD370/PD420/PD470/PD520

conforms with the provisions of:

Council Directive 89/336/EEC and amended by 92/31/EEC and 93/68/EEC on Electromagnetic Compatibility;

EN55022:1998 Radiated and Conducted Emissions from IT Equipment

EN55024:1998 Immunity of IT Equipment

Including: EN61000-4-2 Electrostatic Discharge
EN61000-4-3 Radiated Immunity
EN61000-4-4 Electrical Fast Transients
EN61000-4-5 Line Surge
EN61000-4-6 RF Conducted Susceptibility
EN61000-4-8 Magnetic Field Immunity
EN61000-4-11 Voltage Dips and Interrupts

And: EN61000-3-2 Harmonic Current Emissions
EN61000-3-3 Voltage fluctuations and Flicker

Council Directive 73/23/EEC and amended by M1 and C1 on Low Voltage Equipment Safety:

EN60950:2001 Safety of IT Equipment

The Technical Construction File required by this Directive is maintained at the corporate headquarters of Planar Systems, Inc., 1195 NW Compton Drive., Beaverton, Oregon

Note: This equipment has been tested and found to comply with the limits for a Class B digital device, pursuant to part 15 of the FCC Rules. These limits are designed to provide reasonable protection against harmful interference when the equipment is operated in a commercial environment. This equipment generates, uses, and can radiate radio frequency energy and, if not

installed and used in accordance with the instruction manual, may cause harmful interference to radio communications. Operation of this equipment in a residential area is likely to cause harmful interference in which case the user will be required to correct the interference at his own expense.

Any changes or modifications to the display not expressly approved by Planar Systems, Inc. could void the user's authority to operate this equipment.

Planar Systems, Inc.

Corporate Headquarters
1195 NW Compton Drive
Beaverton, OR 97006-1992

Planar Customer Support

Telephone:
US: 1-866-PLANAR1 (866) 752-6271
Outside US: (503) 748-5799
E-mail: PlanarSupport@planar.com

Online Technical Library: <http://www.planar.com/support>

Hours: M-F, 8am-8pm ET, 12pm-12am GMT

© 2007 Planar Systems, Inc. Planar is a registered trademark of Planar System, Inc.

Other brands and names are the property of their respective owners.

Technical information in this document is subject to change without notice

P/N: 020-0524-00A